

NEW

MP20V
ONE POWERS ALL.

**20V LITHIUM-ION
CORDLESS SYSTEM**



2023 01



TOLSEN



PROFESSIONAL PERFORMANCE WHY CHOOSE TOLSEN?

TOLSEN tools focus on making professional quality tools and hardware products. TOLSEN products are all strictly controlled at every step during designing, producing, packing and quality controlling process. **TOLSEN tools** believe that the quality tools refer to the usability, efficiency and performance. Different from the OEM market, the advantages of **TOLSEN tools** are:



Now we are seeking for the partners overseas all over the world. If you are interested in being our distributors for the whole line hand tools and the relative hardware products, we are sure that you will be very successful when you enter into your market to fight against your competitors.

TOLSEN
TOOLS AND MORE



EXPERIENCED DESIGN TEAM

Our product designers and manufacturing engineers with a high level of technical expertise and skill research materials, design and constant improvement to make work easier.



TOLSEN have experienced artwork designers to create uniform and professional artworks to make the packages popular and impressed with customers.

WELL EQUIPPED TESTING CENTER



ENSURING QUALITY AT EVERY STEP

FOR EXAMPLE, MANUFACTURING PROCESS OF PLIERS

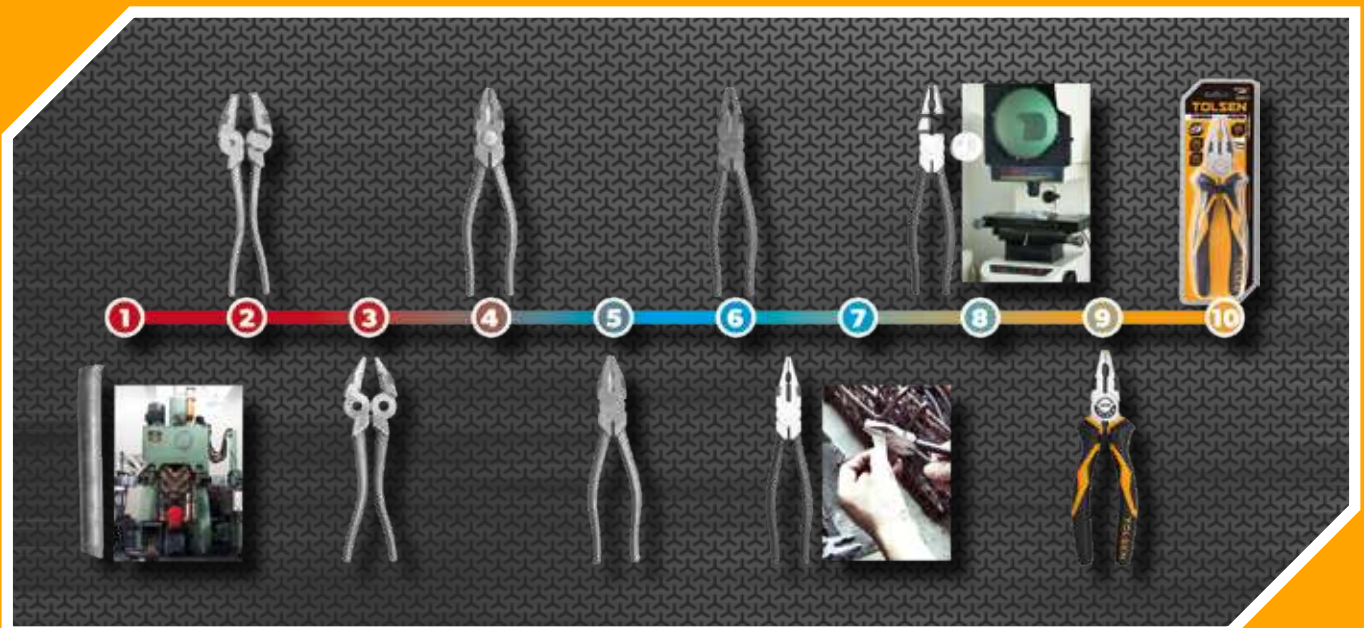

MP20V
ONE POWERS ALL



6-19 20V LITHIUM-ION PLATFORM



**TOOL SETS
20-31**



**HOLDING TOOLS
32-38**



**MECHANICS TOOLS
39-48**



**FASTENING TOOLS
49-61**



**STRIKING TOOLS
62-66**



**CUTTING TOOLS
67-70**



**GARDEN TOOLS
71-79**



**FINISHING TOOLS
80-81**



**PLUMBING TOOLS
82-83**



**MEASURING TOOLS
84-91**



**ELECTRICAL TOOLS
92-99**



**INSULATED TOOLS
100-106**



**PAINTING & MASONRY TOOLS
107-115**



**PPE
116-121**



**AUTOMOTIVE TOOLS
122-126**



**WELDING TOOLS
127-128**



**POWER TOOLS
129-151**



**POWER TOOL ACCESSORIES
152-167**



**GENERATORS
168-171**



**CONSTRUCTION
EQUIPMENT
172-176**



**PNEUMATIC TOOLS
177-183**



**HARDWARE
184-185**



**OTHERS
186-192**



**TOOL BAG & STORAGE
193-195**



**NON-SPARKING TOOLS
196-200**



**MARKETING
MATERIAL
201**

TOLSEN

MASTER PERFORMANCE CORDLESS SYSTEM



MP

LITHIUM ION

BL BRUSHLESS MOTOR

LI-ION CORDLESS IMPACT DRILL

INDUSTRIAL

- Brushless motor
 - CE approval
 - Li-Ion battery
 - Metal keyless chuck
 - Spindle automatic locking
 - Step speed selection
 - Electronic speed adjustment
 - Reverse function
 - Variable torque
 - 3 modes (screwdriving / drilling / impact drilling)
 - LED light
 - LED battery power indicator
 - Belt hook
- Includes:
- 2pcs 2.0Ah battery pack
 - 1pc battery charger: 220-240VAC 50/60Hz, Europlug, 1hr fast charging
 - HSS drill bits: 3,4,5,6mm
 - Masonry drill bits: 5,6,8mm
 - 6pcs bits: 5mm,6,5mm,PH1,PH2,PZ1,PZ2
 - 1pcs magnetic nut socket: 1/4"x60mm
 - Packing: BMC+color sleeve



**MP20^V LITHIUM-ION
13mm**

**METAL
CHUCK**

**BL BRUSHLESS
MOTOR**



LI-ION CORDLESS IMPACT DRILL

- CE approval
 - Li-Ion battery
 - Keyless chuck
 - Spindle automatic locking
 - Step speed selection
 - Electronic speed adjustment
 - Reverse function
 - Variable torque
 - 3 modes (screwdriving / drilling / impact drilling)
 - LED light
 - LED battery power indicator
 - Belt hook
- Includes:
- 2pcs 2.0Ah battery pack
 - 1pc battery charger: 220-240VAC 50/60Hz, Europlug, 1hr fast charging
 - HSS drill bits: 3,4,5,6mm
 - Masonry drill bits: 5,6,8mm
 - 6pcs bits: 5mm,6,5mm,PH1,PH2,PZ1,PZ2
 - 1pcs magnetic nut socket: 1/4"x60mm
 - Packing: BMC+color sleeve



**MP20^V LITHIUM-ION
10mm**

**T HAMMER
FUNCTION**



LI-ION CORDLESS IMPACT DRILL

- CE approval
 - Li-Ion battery
 - Metal keyless chuck
 - Spindle automatic locking
 - Step speed selection
 - Electronic speed adjustment
 - Reverse function
 - Variable torque
 - 3 modes (screwdriving / drilling / impact drilling)
 - LED light
 - LED battery power indicator
 - Belt hook
- Includes:
- 2pcs 2.0Ah battery pack
 - 1pc battery charger: 220-240VAC 50/60Hz, Europlug, 1hr fast charging
 - HSS drill bits: 3,4,5,6mm
 - Masonry drill bits: 5,6,8mm
 - 6pcs bits: 5mm,6,5mm,PH1,PH2,PZ1,PZ2
 - 1pcs magnetic nut socket: 1/4"x60mm
 - Packing: BMC+color sleeve



**MP20^V LITHIUM-ION
13mm**

**METAL
CHUCK**

**T HAMMER
FUNCTION**



**T HAMMER
FUNCTION**



Rated voltage	20V
No-load speed	0-500/0-2000min ⁻¹
Impact rate	8000/32000 bpm
Chuck capacity	2-13mm
Max. torque	58 N·m
Clutch	21+1+1 setting
Max. drilling capacity in wood	38mm
Max. drilling capacity in steel	13mm
Max. drilling capacity in concrete	13mm

STOCK NO.	QTY./CARTON
87254	4

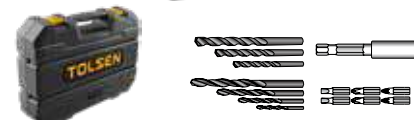

Rated voltage	20V
No-load speed	0-400/0-1500min ⁻¹
Impact rate	6000/22500 bpm
Chuck capacity	0.8-10mm
Max. torque	35 N·m
Clutch	21+1+1 setting
Max. drilling capacity in wood	25mm
Max. drilling capacity in steel	10mm
Max. drilling capacity in concrete	10mm

STOCK NO.	QTY./CARTON
87213	5



Rated voltage	20V
No-load speed	0-450/0-1700min ⁻¹
Impact rate	7200/27200 bpm
Chuck capacity	2.0-13mm
Max. torque	55 N·m
Clutch	21+1+1 setting
Max. drilling capacity in wood	35mm
Max. drilling capacity in steel	13mm
Max. drilling capacity in concrete	13mm

STOCK NO.	QTY./CARTON
87215	5

LI-ION CORDLESS DRILL

- Brushless motor
 - CE approval
 - Li-Ion battery
 - Metal keyless chuck
 - Spindle automatic locking
 - Step speed selection
 - Electronic speed adjustment
 - Reverse function
 - Variable torque
 - 2 modes (screwdriving / drilling)
 - LED light
 - LED battery power indicator
 - Belt hook
- Includes:
- 1pc 2.0Ah battery pack
 - 1pc battery charger: 100-240VAC 50/60Hz, Europlug, 1hr fast charging
 - Packing: color box

INDUSTRIAL

RoHS

MP20[®] LITHIUM-ION

BL BRUSHLESS MOTOR

METAL CHUCK

13mm



Rated voltage	20V
No-load speed	0-500/0-2000min ⁻¹
Chuck capacity	2-13mm
Max. torque	58 N·m
Clutch	21+1 setting
Max. drilling capacity in wood	38mm
Max. drilling capacity in steel	13mm

STOCK NO.	QTY./CARTON
87252	6

LI-ION CORDLESS DRILL

- CE approval
 - Li-Ion battery
 - Keyless chuck
 - Step speed selection
 - Electronic speed adjustment
 - Reverse function
 - Variable torque
 - 2 modes (screwdriving / drilling)
 - LED light
 - LED battery power indicator
 - Belt hook
- Includes:
- 2pcs 2.0Ah battery pack
 - 1pc battery charger: 220-240VAC 50/60Hz, Europlug, 1hr fast charging
 - Packing: canvas bag with color box

RoHS

MP20[®] LITHIUM-ION

10mm



Rated voltage	20V
No-load speed	0-400/0-1500min ⁻¹
Chuck capacity	0.8-10mm
Max. torque	35 N·m
Clutch	21+1 setting
Max. drilling capacity in wood	25mm
Max. drilling capacity in steel	10mm

STOCK NO.	QTY./CARTON
87212	6

LI-ION CORDLESS IMPACT DRIVER

- Brushless motor
 - CE approval
 - Li-Ion battery
 - 1/4" hexagonal tool holder
 - Electronic speed adjustment
 - Variable torque
 - Reverse function
 - Integrated LED light
 - LED battery power indicator
 - Belt hook
- Includes:
- 2pcs 2.0Ah battery pack
 - 1pc battery charger: 100-240VAC 50/60Hz, Europlug, 1hr fast charging
 - Packing: canvas bag with color box

INDUSTRIAL

RoHS

MP20[®] LITHIUM-ION

BL BRUSHLESS MOTOR

1/4" 6.35mm



Rated voltage	20V
No-load speed	0-2900min ⁻¹
Impact rate	0-3000 ipm
Max. torque	200 N·m
Chuck type	1/4" Hex

STOCK NO.	QTY./CARTON
87256	4

INDUSTRIAL

LI-ION CORDLESS IMPACT WRENCH

- Brushless motor
 - CE approval
 - Li-Ion battery
 - Electronic speed adjustment
 - Reverse function
 - Variable torque
 - LED battery power indicator
 - Integrated LED light
 - Belt hook
- Includes:
2pcs 2.0Ah battery pack
1pc battery charger: 100-240VAC 50/60Hz,
Europlug, 1hr fast charging
- Packing: canvas bag with color box



**MP20^V LITHIUM-ION
BL BRUSHLESS MOTOR**

1/2"



Rated voltage	20V
No-load speed	0-2500min ⁻¹
Impact rate	0-3000 ipm
Max. torque	300 N·m
Square drive	1/2"

STOCK NO.	QTY./CARTON
87258	4

LI-ION CORDLESS COMBO KIT

- CE approval
- Contains:
1pc Li-ion cordless drill
Li-Ion battery
Keyless chuck
Step speed selection
Electronic speed adjustment
Reverse function
Variable torque
2 modes (screwdriving / drilling)
- LED light
- Belt hook
- Li-ion cordless impact driver**
Li-Ion battery
1/4" hexagonal tool holder
Electronic speed adjustment
Variable torque
Reverse function
Integrated LED light
- Belt hook
- Includes:
2pcs 2.0Ah battery pack
1pc battery charger: 220-240VAC 50/60Hz,
Europlug, 1hr fast charging
LED battery power indicator
- Packing: canvas bag with color box

MP20^V LITHIUM-ION



Li-ion cordless drill(87211)

Rated voltage	20V
No-load speed	0-400/0-1500min ⁻¹
Chuck capacity	0.8-10mm
Max. torque	35 N·m
Clutch	21+1 setting
Max.drilling capacity in wood	25mm
Max.drilling capacity in steel	10mm

Li-ion cordless impact driver(87220)

Rated voltage	20V
No-load speed	0-2900min ⁻¹
Impact rate	3000 ipm
Max. torque	200 N·m
Chuck type	1/4" Hex

STOCK NO.	QTY./CARTON
87239	4

LI-ION CORDLESS COMBO KIT

- CE approval
- Contains:
1pc Li-ion cordless drill
Li-Ion battery
Keyless chuck
Step speed selection
Electronic speed adjustment
Reverse function
Variable torque
2 modes (screwdriving / drilling)
- LED light
- Belt hook
- 1pc Li-ion cordless impact wrench**
Li-Ion battery
Electronic speed adjustment
Reverse function
Variable torque
LED light
Belt hook
- Includes:
2pcs 2.0Ah battery pack
1pc battery charger: 220-240VAC 50/60Hz,
Europlug, 1hr fast charging
LED battery power indicator
- Packing: canvas bag with color box

MP20^V LITHIUM-ION



Li-ion cordless drill(87211)

Rated voltage	20V
No-load speed	0-400/0-1500min ⁻¹
Chuck capacity	0.8-10mm
Max. torque	35 N·m
Clutch	21+1 setting
Max.drilling capacity in wood	25mm
Max.drilling capacity in steel	10mm

Li-ion cordless impact wrench(87222)

Rated voltage	20V
Square drive	1/2"
No-load speed	0-2500 min ⁻¹
Impact rate	3000 ipm
Max. torque	330 N·m

STOCK NO.	QTY./CARTON
87240	4

LI-ION CORDLESS ROTARY HAMMER

- Brushless motor
- CE approval
- SDS-Plus chuck
- Rotation speed stabilization system
- Anti-vibrations system
- Safety clutch
- Battery/charger not included
- Packing: color box

INDUSTRIAL

RoHS

MP20^V LITHIUM-ION

BL BRUSHLESS MOTOR

24mm SDS-PLUS

3 FUNCTIONS



TOOL ONLY
BATTERY AND CHARGER SOLD SEPARATELY

Rated voltage	20V
No-load speed	0-1200min ⁻¹
Blows per minute	0-4800 bpm
Impact energy	2.5J
Drill diameter in concrete	25mm
Drill diameter in steel	13mm
Drill diameter in wood	40mm

STOCK NO.	QTY./CARTON
87272	4

LI-ION CORDLESS ANGLE GRINDER

- Brushless motor
- CE approval
- Soft start
- Restart protection
- Safety clutch
- Quick adjustable protective casing
- Soft grip
- Battery/charger not included
- With 1pc side handle and 1pc wrench
- Packing: color box

INDUSTRIAL

RoHS

MP20^V LITHIUM-ION

BL BRUSHLESS MOTOR

Ø125mm 5"

QUICK ADJUSTABLE PROTECTIVECASING



M14



TOOL ONLY
BATTERY AND CHARGER SOLD SEPARATELY

Rated voltage	20V
Diameter of wheel	125mm / 5"
No-load speed	10000min ⁻¹
Spindle thread	M14

STOCK NO.	QTY./CARTON
87278	4

LI-ION CORDLESS ANGLE GRINDER

- CE approval
- Soft start
- Restart protection
- Safety clutch
- Quick adjustable protective casing
- Soft grip
- Battery/charger not included
- With 1pc side handle and 1pc wrench
- Packing: color box

RoHS

MP20^V LITHIUM-ION

BL BRUSHLESS MOTOR

Ø115mm 4-1/2"

QUICK ADJUSTABLE PROTECTIVECASING



M14



TOOL ONLY
BATTERY AND CHARGER SOLD SEPARATELY

Rated voltage	20V
Diameter of wheel	115mm / 4-1/2"
No-load speed	8500min ⁻¹
Spindle thread	M14

STOCK NO.	QTY./CARTON
87223	4

LI-ION CORDLESS RECIPROCATING SAW

- Brushless motor
- CE approval
- Stroke rate regulation
- Lock-off function
- Saw blade quick changing system
- Integrated LED light
- Soft grip
- Battery/charger not included
- Packing: color box

INDUSTRIAL

RoHS

MP20^V LITHIUM-ION

BL BRUSHLESS MOTOR

SAW BLADE QUICK CHANGING SYSTEM

QUICK ADJUSTABLE BASE PLATE

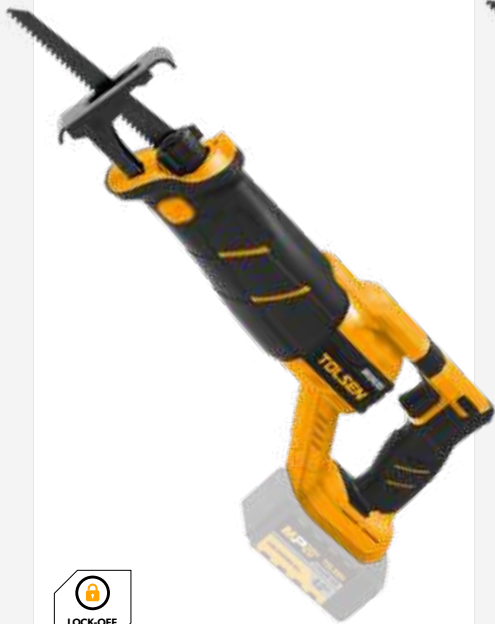

TOOL ONLY
BATTERY AND CHARGER SOLD SEPARATELY

Rated voltage	20V
No-load speed	0-2500min ⁻¹
Stroke length	28mm
Cutting capacity in wood	180mm
Cutting capacity in metal	8mm

STOCK NO.	QTY./CARTON
87280	6

LI-ION CORDLESS RECIPROCATING SAW

- CE approval
- Stroke rate regulation
- Lock-off function
- Saw blade quick changing system
- Integrated LED light
- Soft grip
- Battery/charger not included
- Packing: color box

RoHS

MP20^V LITHIUM-ION

SAW BLADE QUICK CHANGING SYSTEM

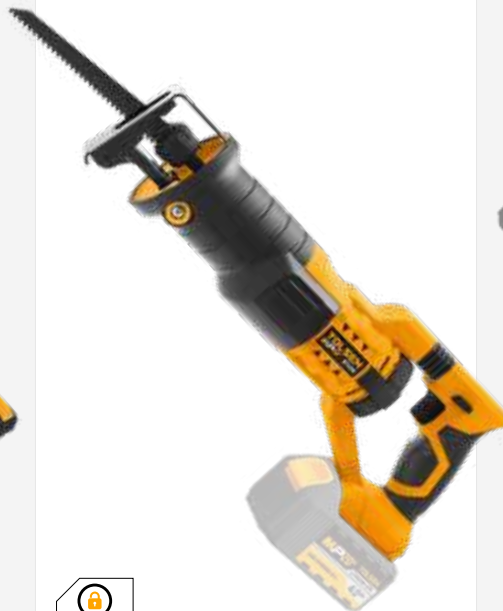

TOOL ONLY
BATTERY AND CHARGER SOLD SEPARATELY

Rated voltage	20V
No-load speed	0-2800min ⁻¹
Stroke length	22mm
Cutting capacity in wood	125mm
Cutting capacity in metal	6mm

STOCK NO.	QTY./CARTON
87228	6

LI-ION CORDLESS CIRCULAR SAW

- Brushless motor
- CE approval
- Soft start
- Spindle lock function
- Locking switch with auxiliary handle
- Aluminium base plate
- Integrated LED light
- Battery/charger not included
- Packing: color box

INDUSTRIAL

RoHS

MP20^V LITHIUM-ION

BL BRUSHLESS MOTOR

Ø190mm



TOOL ONLY
BATTERY AND CHARGER SOLD SEPARATELY

Rated voltage	20V
No-load speed	3800min ⁻¹
Circular saw blade	Ø190mm
Bore	Ø20mm
Max. cutting depth at 90°	62mm
Max. cutting depth at 45°	43mm

STOCK NO.	QTY./CARTON
87282	2

LI-ION CORDLESS CIRCULAR SAW

- CE approval
- Soft start
- Spindle lock function
- Locking switch with auxiliary handle
- Aluminium base plate
- Integrated LED light
- Battery/charger not included
- Packing: color box

NEW

RoHS

MP20^V LITHIUM-ION

Ø160mm



TOOL ONLY
BATTERY AND CHARGER
SOLD SEPARATELY

Rated voltage	20V
No-load speed	3500min ⁻¹
Circular saw blade	Ø160mm
Bore	Ø20mm & 5/8"
Max. cutting depth at 90°	53mm
Max. cutting depth at 45°	38mm

STOCK NO.	QTY./CARTON
87225	2

LI-ION CORDLESS RANDOM ORBIT SANDER

- CE approval
- 1pc dust bag
- 2pcs sand papers
- Battery/charger not included
- Packing: color box

NEW

RoHS

MP20^V LITHIUM-ION

Ø125mm 5"



TOOL ONLY
BATTERY AND CHARGER
SOLD SEPARATELY

Rated voltage	20V
No-load speed	7000-11000min ⁻¹
Diameter of pad	125mm / 5"
Diameter of dust pipe	39.5mm

STOCK NO.	QTY./CARTON
87233	6

LI-ION CORDLESS VACUUM CLEANER

- CE approval
- Ø32mm hose diameter
- Stainless steel tank
- 1pc 1.5 meter flexible hose
- 1pc telescopic stainless steel metal pipe 48cm-78cm, 15 positions
- 1pc flat mouth
- 1pc floor brush for wet and dry
- 4pcs universal casters
- 1pc HEPA filter
- 1pc cleanable column filter
- 1pc anti-static chain
- Battery / Charger not included
- Packing: color box

NEW

RoHS

MP20^V LITHIUM-ION

150W 20L



STAINLESS STEEL TANK

TOOL ONLY
BATTERY AND CHARGER
SOLD SEPARATELY

Rated voltage	20V
Output power	150W
Dust capacity	20L
Vacuity	10Kpa
Air flow	10L/s

STOCK NO.	QTY./CARTON
87338	1

LI-ION LED WORK LIGHT

- CE approval
- Soft grip
- Belt clip
- 3 Model shift: 1000lm, 500lm, SOS, Off
- Battery/charger not included
- Packing: color box



MP20^V LITHIUM-ION

LED

Day Light



TOOL ONLY
BATTERY AND CHARGER
SOLD SEPARATELY

Rated voltage	20V
LED power	10W
Lumens	1000Lm / 500Lm
CCT	6500K (Daylight)

STOCK NO.	QTY./CARTON
87311	8

LI-ION FLOOD LIGHT

- CE approval
- Compact design
- Swiveling Stand
- 2 Model shift: 2000lm, 900lm
- Battery/charger not included
- Packing: color box



MP20^V LITHIUM-ION

LED

Day Light



SWIVELING STAND



TOOL ONLY
BATTERY AND CHARGER
SOLD SEPARATELY

Rated voltage	20V
LED power	20W
Number of LEDs	36
Lumens	2000Lm / 900Lm
CCT	6500K (Daylight)

STOCK NO.	QTY./CARTON
87312	8

LI-ION CORDLESS BLOWER

- Brushless motor
- CE approval
- 2-speed design to match the speed to application
- Variable speed control trigger
- Good ergonomics and balanced Layout
- Light weight body
- Rubberised end piece of the blow tube to protect delicate surfaces
- Battery/charger not included
- Packing: color box



MP20^V LITHIUM-ION

BL BRUSHLESS MOTOR

2 SPEED
MATCH THE SPEED TO APPLICATION

Compact Lightweight

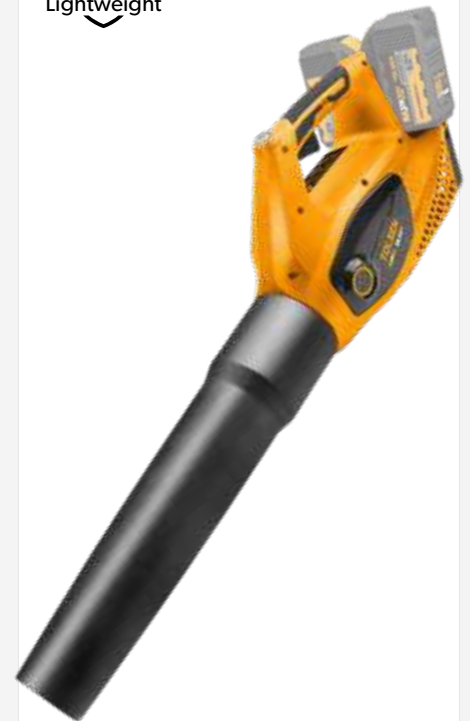

TOOL ONLY
BATTERY AND CHARGER
SOLD SEPARATELY

Rated voltage	40V(2x20V)
No-load speed	17500/22500 min ⁻¹
Max.output power	800W
Air velocity	High 59m/s Low 47m/s
Air volume	High 453cfm Low 360cfm
Net weight	2.5kg

STOCK NO.	QTY./CARTON
87340	2

LI-ION CORDLESS CHAIN SAW

- Brushless motor
- CE approval
- High chain speed for fast cutting
- Variable speed control trigger
- Quick change chain adjustments system
- Electronic brake + mechanical brake
- Battery/charger not included
- Packing: color box

INDUSTRIAL



MP20^V LITHIUM-ION

BL BRUSHLESS MOTOR

2 SPEED
MATCH THE SPEED TO APPLICATION

QUICK CHANGE CHAIN ADJUSTMENTS SYSTEM



TOOL ONLY
BATTERY AND CHARGER SOLD SEPARATELY

Rated voltage	40V(2x20V)
Output power	1000W
Guide bar length	14"(355mm)
Chain speed	6m/s & 12m/s
Chain pitch	3/8"
Net weight	3.8kg

STOCK NO.	QTY./CARTON
87360	2

LI-ION CORDLESS CHAIN SAW

- CE approval
- Quick change chain adjustments system
- Torsional spring brake
- Battery/charger not included
- Packing: color box

INDUSTRIAL



MP20^V LITHIUM-ION

QUICK CHANGE CHAIN ADJUSTMENTS SYSTEM



TOOL ONLY
BATTERY AND CHARGER SOLD SEPARATELY

Rated voltage	20V
Output power	400W
Guide bar length	10"(250mm)
Chain speed	6m/s
Chain pitch	3/8"
Net weight	2.6kg

STOCK NO.	QTY./CARTON
87362	2

LI-ION CORDLESS MINI CHAIN SAW

- Brushless motor
- CE approval
- Auto-oiling system
- Splash guard
- Battery/charger not included
- Packing: color box

INDUSTRIAL

NEW



MP20^V LITHIUM-ION

BL BRUSHLESS MOTOR

AUTO-OILING SYSTEM



TOOL ONLY
BATTERY AND CHARGER SOLD SEPARATELY

Rated voltage	20V
Output power	400W
Guide bar length	8"(200mm)
Chain speed	7.5m/s
Chain pitch	1/4"
Net weight	2.6kg

STOCK NO.	QTY./CARTON
87366	4

LI-ION CORDLESS HEDGE TRIMMER

- CE approval
- Diamond-ground blade teeth on both sides
- 65Mn blade increases cutting capacity
- Electronic quick stop of the blade
- Low-vibration design
- Perfect ergonomics and soft-grip handle
- Battery/charger not included
- Packing: color box

RoHS

MP20^V LITHIUM-ION

65Mn BLADE
INCREASES CUTTING CAPACITY



TOOL ONLY
BATTERY AND CHARGER SOLD SEPARATELY

Rated voltage	20V
Output power	200W
Cutting length	18"(450mm)
Cutting strength	Ø18mm
Strokes	0-2000SPM
Net weight	2kg

STOCK NO.	QTY./CARTON
87370	2

LI-ION CORDLESS STRING TRIMMER

- CE approval
- 2 telescopic aluminum tubes with trimming function
- Flower protection frame
- Auxiliary handle can be rotated
- Perfect ergonomics and soft-grip handle
- Packing: color box

RoHS

MP20^V LITHIUM-ION

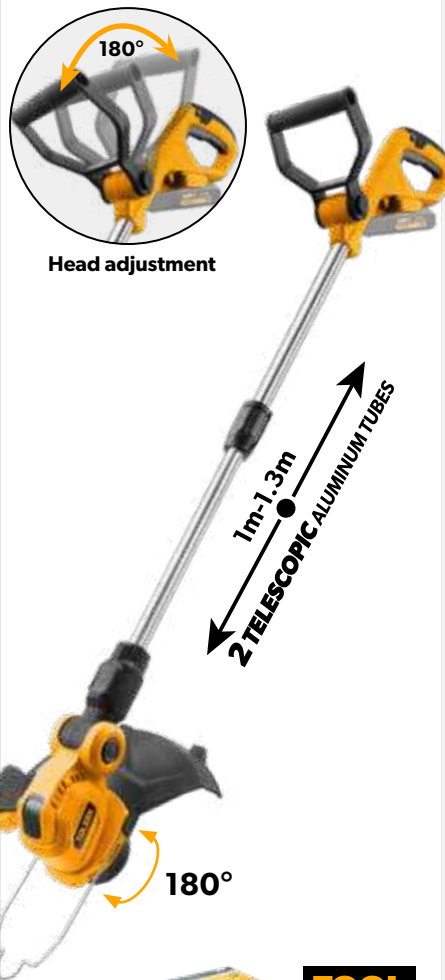

TOOL ONLY
BATTERY AND CHARGER SOLD SEPARATELY

Rated voltage	20V
Output power	200W
No-load speed	7500 min ⁻¹
Cutting capacity (diameter)	300mm
Head adjustment cutting angle	0°/ 22.5°/ 45°/ 67.5°/ 90°
Max. cutting trimmer line	Ø1.6mm
Net weight	1.8kg

STOCK NO.	QTY./CARTON
87372	2

LI-ION CORDLESS PRUNING SHEAR

- Brushless motor
- CE approval
- Li-Ion battery
- SK5 cutting blade
- Shear capacity adjustment
- Electronic speed
- Soft grip
- With wrist strap

- Includes: 2pcs 2.0Ah battery pack
- 1pc battery charger: 220-240VAC 50/60Hz, Europlug, 1hr fast charging
- Packing: BMC + color sleeve

RoHS

MP20^V LITHIUM-ION



SK5



Rated voltage	20V
Shear capacity	20/30mm
Net weight	2.4kg

STOCK NO.	QTY./CARTON
87380	4

LI-ION CORDLESS PRUNING SHEAR

- Brushless motor
- CE approval
- Li-Ion battery
- SK5 cutting blade
- Shear capacity adjustment
- Electronic speed
- Soft grip
- With wrist strap

INDUSTRIAL

RoHS 

MP20V LITHIUM-ION

BL BRUSHLESS MOTOR

SK5



TOOL ONLY
BATTERY AND CHARGER SOLD SEPARATELY

Rated voltage	20V
Shear capacity	20/30mm
Net weight	0.7kg

STOCK NO.	QTY./CARTON
87381	6

BATTERY PACK

- LED battery power indicator
- Compatible with all TOLSEN MP20V cordless tools
- Compatible chargers: 87485 / 87484
- Packing: color box

RoHS CB

MP20V LITHIUM-ION
2.0Ah



LED 3 LEVEL LED BATTERY POWER INDICATOR

Voltage	20V
Battery capacity	2.0Ah

STOCK NO.	QTY./CARTON
87472	24

BATTERY PACK

- LED battery power indicator
- Compatible with all TOLSEN MP20V cordless tools
- Compatible chargers: 87484 / 87485 / 87486
- Packing: color box

RoHS CB

MP20V LITHIUM-ION
4.0Ah



LED 3 LEVEL LED BATTERY POWER INDICATOR

Voltage	20V
Battery capacity	4.0Ah

STOCK NO.	QTY./CARTON
87474	12

BATTERY CHARGER

- CE approval
- For charging TOLSEN 20V 2.0Ah battery 87472
- Charging TOLSEN 20V 2.0 Ah battery in 1Hr
- LED battery power indicator
- Europlug
- Packing: color box

RoHS 

MP20⁺ LITHIUM-ION
2.0A



LED BATTERY POWER INDICATOR

Max. power	60W
Output voltage	21VDC
Input voltage	100-240VAC
Frequency	50/60Hz
Charging current	2.0A

STOCK NO.	QTY./CARTON
87485	24

BATTERY CHARGER

- CE approval
- For charging TOLSEN 20V 4.0Ah battery 87474
- Charging TOLSEN 20V 4.0 Ah battery in 1Hr
- LED battery power indicator
- Europlug
- Packing: color box

RoHS 

MP20⁺ LITHIUM-ION
4.0A



LED BATTERY POWER INDICATOR

Rated power	110W
Output voltage	20VDC
Input voltage	220-240VAC
Frequency	50/60Hz
Charging current	4.0A

STOCK NO.	QTY./CARTON
87486	12

LI-ION USB-A ADAPTOR

- CE approval
- 1W LED work light
- Short circuit protection
- Over discharging protection
- Packing: blister card

RoHS 

NEW

MP20⁺ LITHIUM-ION
5VDC 2A LED WORK LIGHT



Rated voltage	20V
Output power	5VDC/2A
LED work light	1W

STOCK NO.	QTY./CARTON
87308	60

TOOL BAG

- The top opening design is convenient for accessing tools
- Fully covered with flexible lining material, protecting tools inside perfectly.
- There are two built-in partition boards, which can provide various combination methods. Separating and using the internal space effectively, and prevent the collision between tools.

NEW

MP20⁺ LITHIUM-ION
41x20x26cm



Size	41x20x26cm
Capacity	8.5KG
Net weight	790g

STOCK NO.	QTY./CARTON
80042	6

CORDLESS SCREWDRIVER

- CE approved
- Voltage: 3.6V
- Power: Li-ion, 1300mAh
- No-load speed: 180rpm
- Max. torque: 3Nm
- Chuck: 1/4" (6.35mm)
- Charger: AC100-240V, 50/60Hz Europlug
- Charge time: 3-5 hours
- Switch: forward & reverse
- 18pcs 25mm screwdriver bits:
 - Slot: 3, 4, 5
 - Phillips: PH0, PH1, PH2
 - Pozidriv: PZ0, PZ1, PZ2
 - Hex: H2.0, H2.5, H3.0, H4.0
 - Torx: T8, T10, T15, T20, T25
- 2pcs 50mm screwdriver bits:
 - Slot: 4
 - Phillips: PH2
- 3pcs HSS twist drill bits: 2, 2.5, 3mm
- 1pc 60mm magnetic bit holder
- Packing: double blister



3.6V LITHIUM



STOCK NO.	SIZE	QTY./CARTON
79010	3.6V	4

LI-ION IMPACT DRIVER

- CE/EMC approved
- Voltage: DC 12V
- Power: Li-ion, 1x1500mAh
- No-load speed: 0-2400rpm
- Impact rate: 3000ipm
- Max. torque: 100Nm
- 1/4" (6.35mm) quick release bit holder
- 3 level LED battery power indicator and one power Light
- Soft grip handle
- Packing: color box



12V LITHIUM

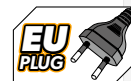

STOCK NO.	SIZE	QTY./CARTON
79025	12V	10

LI-ION CORDLESS DRILL

- CE approval
- Voltage: DC 12V
- Power: Li-ion, 1x1500mAh
- No-load speed: 0-400rpm / 0-1400rpm
- Clutch: 18+1 setting rings
- Max torque: 28N.m
- Chuck: 10mm keyless chuck
- Switch: forward & reverse
- Charger : AC 100-240V, Europlug
- Charging time: 1h fast charging
- 3 lever LED battery power indicator and one power Light
- Soft grip handle
- Packed in color box



12V LITHIUM 10mm



STOCK NO.	SIZE	QTY./CARTON
79036	12V/10mm	10
79036-BS	12V/10mm	10

LI-ION IMPACT DRIVER

- CE/EMC approved
- Voltage: DC 12V
- Power: Li-ion, 1x1500mAh
- No-load speed: 0-2400rpm
- Impact rate: 3100ipm
- Max. torque: 100Nm
- 1/4"(6.35mm) quick release bit holder
- 3 level LED battery power indicator and one power Light
- Soft grip handle
- Packing: color box



12V LITHIUM

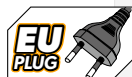

STOCK NO.	SIZE	QTY./CARTON
79037	12V	10

LI-ION CORDLESS DRILL & IMPACT DRIVER SET

- CE/EMC approved
- Contains:
 - Tpc li-ion cordless drill**
 - Voltage: DC 12V
 - Power: Li-ion, 1x1500mAh
 - No-load speed: 0-400rpm / 0-1400rpm
 - Clutch: 18+1 setting rings
 - Max torque: 28N.m.
 - Chuck: 10mm keyless chuck
 - Switch: forward & reverse
 - Charger : AC 100-240V, Europlug
 - Charging time: 1h fast charging
 - 3 level LED battery power indicator and one power Light
 - Soft grip handle
 - Tpc li-ion impact driver**
 - Voltage: DC 12V
 - Power: Li-ion, 1x1500mAh
 - No-load speed: 0-2400rpm
 - Impact rate: 3100ipm
 - Max. torque: 100Nm
 - 1/4"(6.35mm) quick release bit holder
 - 3 level LED battery power indicator and one power Light
 - Soft grip handle
- Charger : AC 100-240V, Europlug
- Charging time: 1h fast charging
- Packing: Canvas bag with color box

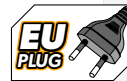

12V LITHIUM



10mm



STOCK NO.	SIZE	QTY./CARTON
79038	12V	10

LI-ION BATTERY PACK

- Voltage: DC 12V
- Power: Li-ion, 1x1.5Ah
- Suitable for TOLSEN 79025

1.5Ah



STOCK NO.	SIZE	QTY./CARTON
79029	12V	36

LI-ION BATTERY PACK

- Voltage: AC 12V
- Power: Li-ion, 1x1.5Ah
- Suitable for TOLSEN 79036, 79037

1.5Ah



STOCK NO.	SIZE	QTY./CARTON
79039	12V	36

INDUSTRIAL

175PCS TOOL SET



- 2pcs Reversible ratchets 1/4" + 1/2"
- 2pcs Extension bars: 1/4"×50mm; 1/4"×100mm
- 1pc 1/4" universal joint
- 1pc 1/4" sliding bar
- 1pc flexible sha: 1/4"×150mm
- 1pc screwdriver handle: 1/4"×65mm
- 21pcs S2 screwdriver bits 1/4"×25mm: 4, 5.5, 6.5mm, PH1, PH2, PH3, PZ1, PZ2, PZ3, T10, T15, T20, T25, T30, T40, H2, H2.5, H3, H4, H5, H6
- 13pcs 1/4" 6 points sockets: 4, 4.5, 5, 5.5, 6, 7, 8, 9, 10, 11, 12, 13, 14mm
- 20pcs 1/2" 6 points sockets: 8, 9, 10, 11, 12, 13, 14, 15, 16, 17, 18, 19, 20, 21, 22, 23, 24, 27, 30, 32mm
- 2pcs Spark plug sockets: 1/2"×16mm; 1/2"×21mm
- 2pcs Extension bars: 1/2"×125mm; 1/2"×250mm
- 1pc 1/2" 3-way adaptor
- 1pc 1/2" universal joint
- 7pcs 1/2" 6 points deep sockets: 8, 10, 12, 13, 14, 17, 19mm
- 5pcs Double end swivel head socket wrench: 8×9mm, 10×11mm, 12×13mm, 14×15mm, 17×19mm



- 10pcs screwdrivers
SL: 6.5×38mm, 3.0×75mm, 5.5×100mm, 6.5×150mm, 8.0×150mm
PH: PH2×38mm, PH0×75mm, PH1×100mm, PH2×150mm, PH3×150mm
- 9pcs ball point long arm hex key: 1.5, 2, 2.5, 3, 4, 5, 6, 8, 10mm
- 9pcs torx long arm hex key: T10, T15, T20, T25, T27, T30, T40, T45, T50
- 1pc Measuring tape: 5m/16ft ×25mm
- 4pcs T-handle screwdriver: H6.0×200mm, H8.0×200mm, T30×150mm, T45×200mm
- 1pc 3-LED telescoping pick up tool



- 5pcs hooks 6x100mm
- 19pcs combination spanners: 6, 7, 8, 9, 10, 11, 12, 13, 14, 15, 16, 17, 18, 19, 20, 21, 22, 23, 24mm
- 5pcs Flare nut spanners: 8x10mm, 11x13mm, 12x14mm, 16x18mm, 17x19mm
- 1pc Two-way mallet: 35mm
- 1pc Machinist hammer: 500g
- 5pcs Punches:
cold chisel: 13x10x150mm, cape chisel: 5x10x150mm, pin chisel: 8x10x150mm, taper chisel: 2x10x150mm, centre chisel: 3x10x150mm



- 1pc 180mm/7" Internal circlip pliers, straight
- 1pc 180mm/7" Internal circlip pliers, bent
- 1pc 180mm/7" External circlip pliers, straight
- 1pc 180mm/7" External circlip pliers, bent
- 1pc 200mm/8" Combination pliers
- 1pc 200mm/8" Long nose pliers
- 1pc 160mm/6" Diagonal cutting pliers
- 1pc 250mm/10" locking pliers
- 1pc 250mm/10" Water pump pliers
- 1pc 250mm/10" adjustable wrench
- 1pc Double function Utility Knife: 61x19mm including 2pcs additional SK2 blades
- 10pcs SK5 blades: 61x19mm



- Chest part:
Overall size: 765x465x730mm
Overall size with caster: 840x465x885mm
Fitted with two fixed and two braked swivelling casters 5"×1.88"
PP material work table with steel handle
Thickness of cabinet: 0.8mm
Thickness of drawer: 0.7mm
Drawers are fitted with EVA foam liner and ball bearing runners for smooth operation & long time;
Secure intergral locking system supplied with two keys;
- Configuration:
4pcs drawers: 549x400x70mm
2pcs drawers: 549x400x140mm
Side storage cabinet features one fixed bucket.



- 1pc Hacksaw frame: 300mm/12", including 1pc bi-metal blade
- 1pair Working gloves
- 1pc Wire Brush: 4Lines



engineered
to
get the job done

STOCK NO.	QTY./CARTON
85410	1

95PCS TOOL SET

• Contains:

-  750W hammer drill:
220-240V, 50Hz, 13mm chuck,
CE approved;
1pc side handle;
1pc depth gauge (plastic)
-  Screwdriver bit holder: 1/4"x60mm
-  Screwdrivers: SL5.5x100mm, PH1x100mm
-  Nut screwdriver: 1/4"x100mm
-  Adjustable wrench: 200mm/8"
-  Combination pliers: 160mm/6"
-  Claw hammer: 8oz, drop forged
-  Mini spirit level: 22.5cm,
aluminium, with magnetic
-  Snap-off blade knife with 3pcs blades
-  Measuring tape: 3M/10ftx16mm
-  Voltage tester: 3x140mm
-  20pcs CrV screwdriver bits, 1/4"x25mm;
T10, T15, T20, T25, T27, T30;
H3, H4, H5, H6;
PH1, PH2, PH3, PZ1, PZ2, PZ3;
SL4, SL5, SL6;
1/4" socket adaptor
-  6pcs 1/4" sockets set: 5, 6, 7, 8, 9, 10mm
-  5pcs masonry drill bits: 4, 5, 6, 8, 10mm
-  4pcs wood drill bits: 4, 5, 6, 8mm
-  5pcs HSS drill bits: 3, 4, 5, 6, 8mm
-  40pcs screws set:
plastic screw plug:
2pcs 8x37mm, 4pcs 6x30mm, 14pcs 5x25mm
wood screws:
2pcs 5x40mm, 4pcs 4x30mm, 14pcs 3x25mm

• Packing: blow mould case

STOCK NO.	QTY./CARTON
79685	3



DURABLE STORAGE CASE

XL













460x335x95 mm

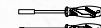
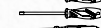

engineered to get the job done

119PCS HOUSEHOLD TOOL SET

• Contains:

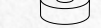
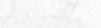
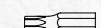
-  Combination pliers: 160mm/6"
-  Long nose pliers: 160mm/6"
-  Water pump pliers 250 mm/10"
-  Claw hammer: 8oz, drop forged
-  Adjustable wrench: 200mm/8"
-  Snap-off blade knife
-  Screwdrivers: SL5.5x100mm, PH1x100mm
-  Nut screwdriver: 1/4"x100mm
-  Voltage tester: 3x140mm
-  9pcs long arm hex key set
1.5/2/2.5/3/4/5/6/8/10mm
-  1pc mini hacksaw frame with blade
150mm/6"
-  Measuring tape: 3Mx16mm
-  Insulated PVC tape
0.13x19mmx9.15m(red color)
-  20pcs CrV screwdriver bits 1/4"x25mm:
T10, T15, T20, T25, T27, T30,
H3, H4, H5, H6,
PH1, PH2, PH3, PZ1, PZ2, PZ3,
SL4, SL5, SL6,
1/4" socket adaptor
-  6pcs 1/4" sockets set: 5, 6, 7, 8, 9, 10mm
-  70pcs nails set:
10pcs iron nails 1.5"
10pcs steel nails 1.5"
10pcs chipboard screws 4x30mm
10pcs plastic screw plugs 5x25mm
10pcs plastic screw plugs 6x30mm
10pcs self-tapping screws ST2.9x25mm
10pcs self-tapping screws ST4.0x30mm

• Packing: blow mould case

STOCK NO.	QTY./CARTON
85350	4



DURABLE STORAGE CASE

L

390x290x90 mm



engineered to get the job done

89PCS HOUSEHOLD TOOL SET

• Contains:



1pc combination pliers: 180mm, 7"



1pc long nose pliers: 200mm, 8"



1pc water pump pliers: 250mm, 10"



1pc claw hammer: 8OZ(23mm/225g)

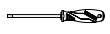

6pcs screwdrivers:
Slot: 1.2x6.5x38mm, 1.0x5.5x100mm, 1.2x6.5x100mm
Phillips: PH2x38mm, PH1x100mm, PH2x100mm

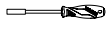

1pc nut screwdriver: 1/4" x 100mm

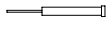

5pcs precision screwdrivers:
Slot 0.4x2x50mm, 0.4x2.5x50mm
Phillips: PH000x50mm, PH00x50mm, PH0x50mm



1pc voltage tester: 100-500V



1pc mini spirit level



1pc measuring tape: 3M x 16mm



1pc reversible ratchet 1/4", 72T



9pcs hex key set:
1.5, 2, 2.5, 3, 4, 5, 6, 8, 10mm

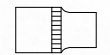

12pcs 1/4"x20.5mm sockets:
4, 4.5, 5, 5.5, 6, 7, 8, 9, 10, 11, 12, 13mm

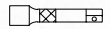

1pc 1/4" CrV extension bars: 50mm

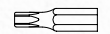

44pcs 1/4" (6.35 x 25mm) CrV bits:
M type: M5, M6, M8
Slot: 4, 5.5, 6.5mm
Torx: T8, T10, T15, T20, T25
Torx with hole: T8, 2xT10, 2xT15, 2xT20, 2xT25, T40
Hex: H3, H4, H5, H6
Hex with hole: H3, H4, H5, H6
Phillips: PH1, PH2
Pozi: PZ1, PZ2
Square: S1, S2
Y type: Y1, Y2, Y3
U type: U4, U6, U8
X type: X6, X8, X10

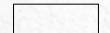

1pc 1/4" bit adapter



1pc 1/4"x25mm socket adapter

• Packing: blow mould case



DURABLE STORAGE CASE

L
390x290x90 mm



engineered
to
get the job done

STOCK NO.











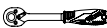



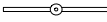

QTY./CARTON

85352

4

116PCS SOCKET AND TOOL SET

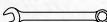
• Contains:

-  2pcs two-component ratchet handles, 72T: 1/2"+1/4"
-  15pcs 1/2" Sq Dr. Cr-V standard metric sockets: 13, 14, 15, 16, 17, 18, 19, 20, 21, 22, 23, 24, 27, 30, 32mm
13pcs 1/4" Sq Dr. Cr-V standard metric sockets: 4, 4.5, 5, 5.5, 6, 7, 8, 9, 10, 11, 12, 13, 14mm
-  6pcs 1/2" Sq Dr. Cr-V deep metric sockets: 10, 12, 13, 14, 17, 19mm
6pcs 1/4" Sq Dr. Cr-V deep metric sockets: 4, 5, 6, 7, 8, 9mm
-  1pc 1/2" Cr-V extension bar: 250mm
1pc 1/4" Cr-V extension bar: 100mm
-  1pc 1/2" Cr-V 3-way adaptor
-  1pc 1/2" Cr-V universal joint
1pc 1/4" Cr-V universal joint
-  2pcs 1/2" Sq Dr. Cr-V spark plug sockets: 16,21mm
-  1pc 1/4" Cr-V sliding bar 115mm
-  1pc 1/4" socket handle 150mm
-  1pc 1/4" Cr-V socket adaptor
-  17pcs socket bits (S2 material of bits):
SL4, SL5.5, SL6.5
PH1, PH2
PZ1, PZ2
H3, H4, H5, H6
T8, T10, T15, T20, T25, T30
-  9pcs Cr-V long arm hex key set: 1.5, 2, 2.5, 3, 4, 5, 6, 8, 10mm
-  4pcs Two-component comfortable grip screwdrivers
SL 1.0x5.5x100mm, 1.2x6.5x150mm
PH1x100mm, PH2x150mm
-  1pc 7" combination pliers
-  1pc 8" long nose pliers
-  1pc 10" water pump pliers
-  9pcs combination spanners: 6, 8, 10, 12, 14, 15, 17, 19, 22mm
-  19pcs S2 bit 1/4" / 6.35x25mm
TB10, TB15, TB20, TB25, TB27, TB30
H3, H4, H5, H6
PH1, PH2, PH3
PZ1, PZ2, PZ3
SL4, SL5.5, SL6.5
1pc 1/4" CrV socket adaptor
-  1pc machinist hammer: 300g

• Packing: blow mould case



DURABLE STORAGE CASE

XL
460x335x95 mm











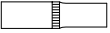





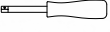
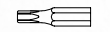

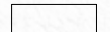

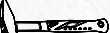

engineered
to
get the job done

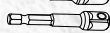
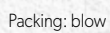
STOCK NO.	QTY./CARTON
85354	2

137PCS SOCKET AND TOOL SET

• Contains:

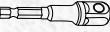
-  10pcs 1/2" Sq Dr. Cr-V standard sockets: 18, 19, 20, 21, 22, 23, 24, 27, 30, 32mm
-  9pcs 3/8" Sq Dr. Cr-V standard sockets: 10, 12, 13, 14, 15, 16, 17, 18, 19mm
-  12pcs 1/4" Sq Dr. Cr-V standard sockets: 4, 4.5, 5, 5.5, 6, 7, 8, 9, 10, 11, 12, 13mm
-  3pcs 1/2" Sq Dr. Cr-V deep stocks: 17, 19, 21mm
-  5pcs 3/8" Sq Dr. Cr-V deep stocks: 11, 12, 13, 14, 15mm
-  5pcs 1/4" Sq Dr. Cr-V deep sockets: 6, 7, 8, 9, 10mm
-  2pcs 1/2" Sq Dr. Cr-V extension bars: 125mm, 250mm
-  1pc 3/8" Sq Dr. Cr-V extension bars: 125mm
-  3pcs 1/4" Sq Dr. Cr-V extension bars: 50, 100, 150mm
-  1pc 1/2" Sq Dr. Cr-V 3-way adaptor
-  1pc 1/4" Sq Dr. Cr-V 3-way adaptor
-  1pc 1/2" Sq Dr. Cr-V spark plug socket: 21mm
-  3pcs 3/8" Sq Dr. Cr-V spark plug sockets: 14, 16, 18mm
-  1pc 1/2" Sq Dr. Cr-V offset handle: 260mm
-  1pc 1/2" Sq Dr. Cr-V flexible handle: 15" 380mm
-  1pc 1/2" Sq Dr. Cr-V universal joint
-  1pc 3/8" Sq Dr. Cr-V universal joint
-  1pc 1/4" Sq Dr. Cr-V universal joint
-  1pc 1/4" Sq Dr. Cr-V socket handle: 150mm
-  1pc 1/4" flexible bar: 150mm
-  33pcs Cr-V bits 1/4" / 6.35x25mm
M type: M5, M6, M8
Slot: 4, 5.5, 6.5mm
Torx: T10, T15, T20, T25, T27, T30, T40
Torx with hole: T10, T15, T20, T25, T27, T30, T40
Hex: H3, H4, H5, H6
Phillips: PH1, PH2, PH3
Pozi: PZ1, PZ2, PZ3
Square: S1, S2, S3
-  1pc bit adaptor: 1/4"x25mm
-  3pcs 72 reversible ratchets: 1/4" + 3/8" + 1/2"
-  1pc combination pliers 7"/180mm
-  1pc long nose pliers 6"/160mm
-  1pc Cr-V lock pliers 10"/250mm
-  1pc nut screwdriver: 1/4"x100mm
-  3pcs Cr-V socket adaptor: 1/4"x65mm, 3/8"x65mm, 1/2"x72mm

• Packing: blow mould case with color sleeve



DURABLE STORAGE CASE

XXL

500x360x100mm



engineered
to
get the job done

STOCK NO.







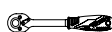
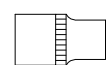
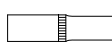
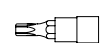
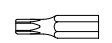

QTY./CARTON

85355

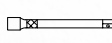
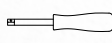
2

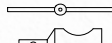
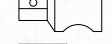
94PCS SOCKET SET

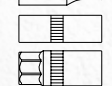
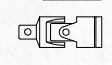
• Contains:

-  2pcs two-component ergonomic ratchet handle: 1/2", 1/4", 72T
-  13pcs 1/4" CrV standard metric sockets: 4, 4.5, 5, 5.5, 6, 7, 8, 9, 10, 11, 12, 13, 14mm
18pcs 1/2" CrV standard metric sockets: 10, 11, 12, 13, 14, 15, 16, 17, 18, 19, 20, 21, 22, 23, 24, 27, 30, 32mm
-  8pcs 1/4" CrV deep metric sockets: 6, 7, 8, 9, 10, 11, 12, 13mm
4pcs 1/2" CrV deep metric sockets: 14, 15, 17, 19mm
-  17pcs socket bits (S2 material of bits): SL4, SL5.5, SL7, PH1, PH2, PZ1, PZ2, T8, T10, T15, T20, T25, T30, H3, H4, H5, H6
-  15pcs CrV bits: 8x30mm
SL8, SL10, SL12mm
PH3, PH4, PZ3, PZ4
T40, T45, T50, T55
H8, H10, H12, H14
-  1pc 1/4" CrV socket adaptor
-  2pcs CrV 1/4" extension bar: 50, 100mm
2pcs CrV 1/2" extension bar: 125, 250mm
-  1pc 1/4" CrV socket handle: 150mm
-  1pc 1/4" CrV flexible bar: 150mm
-  1pc CrV 1/4" sliding bar: 115mm
-  1pc CrV 1/2" 3-way adaptor
-  1pc CrV bit adaptor: 1/2" x 38mm
-  2pcs CrV spark plug sockets: 16, 21mm
-  1pc CrV 1/2" universal joint
1pc CrV 1/4" universal joint
-  3pcs CrV hex keys: 1.5, 2.0, 2.5mm

• Packing: blow mould case



DURABLE STORAGE CASE

L
390x290x90 mm



engineered to get the job done

STOCK NO.	QTY./CARTON
15145	3

175PCS SOCKET SET

• Contains:

- 

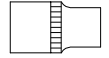
3pcs reversible ratchets: 1/4", 3/8", 1/2", 72T
- 

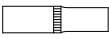
17pcs 1/2" CrV sockets: 10,11,12,13,14,15,16,17,18,19,20,21,22,24,27,30,32mm
 10pcs 3/8" CrV sockets: 10,11,12,13,14,15,16,17,18,19mm
 13pcs 1/4" CrV sockets: 4,4.5,5,5.5,6,7,8,9,10,11,12,13,14mm
- 

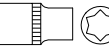
5pcs 1/2" CrV deep sockets: 16,17,18,19,22mm
 6pcs 3/8" CrV deep sockets: 10,11,12,13,14,15mm
 7pcs 1/4" CrV deep sockets: 4,5,6,7,8,9,10mm
- 

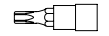
2pcs 1/2" CrV star sockets: E20, E24
 6pcs 3/8" CrV star sockets: E10,E11,E12,E14,E16,E18
 5pcs 1/4" CrV star sockets: E4,E5,E6,E7,E8
- 

30pcs 1/4" x 38mm socket bits (S2 material of bits):
 Slot: 4, 5.5, 6.5, 7mm
 Phillips: PH0, PH1, PH2
 Pozi: PZ0, PZ1, PZ2
 Hex: H3, H4, H5, H6
 Torx: T8, T9, T10, T15, T20, T25, T27, T30
 Torx with hole: TB8, TB9, TB10, TB15, TB20, TB25, TB27, TB30
- 

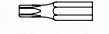
24pcs 5/16" (8 x 30mm) S2 bits:
 Slot: 8, 10,12mm
 Phillips: PH3, PH4
 Pozi: PZ3, PZ4
 Hex: H7, H8, H10, H12, H14
 Torx: T40, T45, T50, T55, T60, T70
 Torx with hole: TB40, TB45, TB50, TB55, TB60, TB70
- 

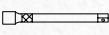
22pcs 1/4"(6.35 x 25mm) S2 bits:
 U type: U4, U6, U8
 Y type: Y1, Y2, Y3
 X type: X6, X8, X10
 M type: M5, M6, M8
 Square: S0, S1, S2
 Hex: H3, H4, H5, H6
 Clutch: C1, C2, C3
- 

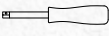
2pcs 1/2" CrV extension bars: 125, 250mm
 1pc 3/8" CrV extension bar: 125mm
 2pcs 1/4" CrV extension bars: 50, 100mm
- 

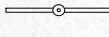
1pc 1/4" CrV socket handle: 150mm
- 

1pc CrV 1/4" sliding bar: 115mm
- 

1pc CrV 1/2" 3-way adaptor
- 

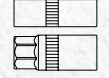
1pc 1/2" CrV bit adaptor: 38mm
 1pc 3/8" CrV bit adaptor: 28mm
 1pc 1/4" CrV bit adaptor: 25mm
- 

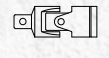
2pcs 1/2" CrV spark plug sockets: 16, 21mm
 1pc 3/8" CrV spark plug socket: 18mm
- 

1pc 1/2" CrV universal joint
 1pc 3/8" CrV universal joint
 1pc 1/4" CrV universal joint
- 

7pcs CrV hex keys:
 1.27, 1.5, 2, 2.5, 3, 4, 5mm

• Packing: blow mould case



DURABLE STORAGE CASE

XL
460x335x95 mm











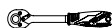

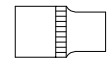
engineered to get the job done

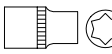
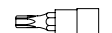
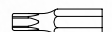
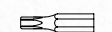
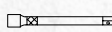
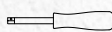
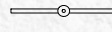
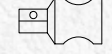
STOCK NO.	QTY./CARTON
15146	2

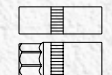
216PCS SOCKET SET

• Contains:

-  3pcs reversible ratchets: 1/4", 3/8", 1/2", 72T
-  12pcs CrV combination spanners: 8, 10, 11, 12, 13, 14, 15, 16, 17, 18, 19, 22mm
-  15pcs 1/2" CrV sockets: 10,11,12,13,14,15,17,19,20,21,22,24,27,30,32mm
10pcs 3/8" CrV sockets: 10,11,12,13,14,15,16,17,18,19mm
13pcs 1/4" CrV sockets: 4,4.5,5,5.5,6,7,8,9,10,11,12,13,14mm
-  5pcs 1/2" CrV deep sockets: 16,17,18,19,22mm
6pcs 3/8" CrV deep sockets: 10,11,12,13,14,15mm
7pcs 1/4" CrV deep sockets: 4,5,6,7,8,9,10mm
-  3pcs 1/2" CrV star sockets: E20, E22, E24
6pcs 3/8" CrV star sockets: E10, E11, E12, E14, E16, E18
5pcs 1/4" CrV star sockets: E4, E5, E6, E7, E8
-  30pcs 1/4" x 38mm socket bits (S2 material of bits):
Slot: 4, 5.5, 6.5, 7mm
Phillips: PH1, PH2, PH3
Pozi: PZ1, PZ2, PZ3
Hex: H3, H4, H5, H6
Torx: T8, T9, T10, T15, T20, T25, T27, T30
Torx with hole: TB8, TB9, TB10, TB15, TB20, TB25, TB27, TB30
2pcs 1/2"x58mm socket bits (S2 material of bits): Torx T55, T60
-  30pcs 5/16" (8 x 30mm) S2 bits:
Slot: 6, 6.5, 8mm
Phillips: PH3, PH4
Pozi: PZ3, PZ4
Hex: H5.5, H6, H6.5, H7, H8
Torx: T25, T27, T30, T35, 2xT40, T45, T50
Torx with hole: TB27, TB30, TB35, TB40, TB45, TB50
M type: M5, M6, M8, M10
-  44pcs 1/4" (6.35 x 25mm) S2 bits:
M type: M5, M6, M8
Slot: 4, 5.5, 6.5mm
Torx: T8, T10, T15, T20, T25
Torx with hole: T8, 2xT10, 2xT15, 2xT20, 2xT25, T40
Hex: H3, H4, H5, H6
Hex with hole: H3, H4, H5, H6
Phillips: PH1, PH2
Pozi: PZ1, PZ2
Square: S1, S2
Y type: Y1, Y2, Y3
U type: U4, U6, U8
X type: X6, X8, X10
-  2pcs 1/2" CrV extension bars: 125, 250mm
1pc 3/8" CrV extension bar: 125mm
2pcs 1/4" CrV extension bars: 50, 100mm
-  1pc 1/4" CrV socket handle: 150mm
-  1pc CrV 1/4" sliding bar: 115mm
-  1pc CrV 1/2" 3-way adaptor
-  1pc 1/2" CrV bit adaptor: 38mm
1pc 3/8" CrV bit adaptor: 28mm
1pc 1/4" CrV bit adaptor: 25mm
-  2pcs 1/2" CrV spark plug sockets: 16, 21mm
1pc 3/8" CrV spark plug socket: 18mm
-  1pc 1/2" CrV universal joint
1pc 3/8" CrV universal joint
1pc 1/4" CrV universal joint
-  1pc nut screwdriver: 1/4"x100mm
-  7pcs CrV hex keys:
1.27, 1.5, 2, 2.5, 3, 4, 5mm

• Packing: blow mould case



DURABLE STORAGE CASE

XXL
500x360x100 mm



engineered to get the job done

STOCK NO.	QTY./CARTON
15147	2

45PCS SOCKET SET

- 18pcs 1/2" CrV sockets: 10, 11, 12, 13, 14, 15, 16, 17, 18, 19, 20, 21, 22, 23, 24, 27, 30, 32mm
- 2pcs two-component ergonomic ratchet handle: 1/2", 1/4"
- 2pc 1/2" CrV extension bar: 125mm, 250mm
- 2pcs CrV spark plug sockets: 16mm, 21mm
- 1pc 1/2" CrV universal joint
- 1pc 1/2" CrV 3way adaptor
- 1pc 1/4" CrV socket handle: 150mm
- 12pcs 1/4" CrV sockets: 4, 5, 5.5, 6, 7, 8, 9, 10, 11, 12, 13, 14mm
- 1pc 1/4" CrV flexible bar: 150mm
- 2pcs 1/4" CrV extension bar: 50, 100mm
- 1pc 1/4" CrV universal joint
- 1pc 1/4" CrV sliding bar
- Packing: blow mould case

1/4"

1/2"



engineered
to
get the job done



M
330x250x70
mm

STOCK NO.	SIZE	QTY./CARTON
15142	1/4", 1/2"	4

22PCS 1/2" SOCKET SET

- 15pcs metric CrV sockets: 10, 11, 12, 13, 14, 15, 16, 17, 18, 19, 22, 24, 27, 30, 32mm
- 2pcs CrV spark plug sockets: 16, 21mm
- 1pc two-component ergonomic ratchet handle, CrV, quick release
- 2pcs CrV extension bar: 125, 250mm
- 1pc CrV universal joint
- 1pc CrV 3way adaptor
- Packing: blow mould case

1/2"



engineered
to
get the job done



M
330x250x70
mm

STOCK NO.	SIZE	QTY./CARTON
15139	1/2"	4

65PCS SOCKET SET (METRIC & INCH)

- 12pcs 1/4" CrV sockets 6PT: 5/32"-3/16"-7/32"-1/4"-9/32"-5/16"; 4mm-4.5mm-5mm-6mm-7mm-8mm
- 12pcs 3/8" CrV sockets 6PT: 11/32"-3/8"-7/16"-1/2"-9/16"-5/8"; 9mm-10mm-11mm-12mm-13mm-14mm
- 12pcs 1/2" CrV sockets 12PT: 11/16"-3/4"-13/16"-7/8"-15/16"-1.0"; 15mm-16mm-17mm-18mm-19mm-24mm
- 1pc 1/4"x3" extension bar
- 1pc 3/8"x3" extension bar
- 1pc 1/2"x5" extension bar
- 1pc 1/4"x2.5" bit handle
- 1pc 1/4" socket adaptor
- 1pc 3 IN 1 ratchet handle; 72T, Crv, quick release
- 22pcs S2 material bits: Slotted: 5/32", 3/16", 7/32", 1/4", 5/16" Phillips: #1, #2, #3 Pozzi #1, #2, #3 Hex: 9/64", 5/32", 3/16", 7/32", 1/4" Star: T15, T20, T25, T27, T30, T40
- Packing: blow mould case



1/4"

3/8"

1/2"

engineered
to
get the job done

STOCK NO.	SIZE	QTY./CARTON
15395	1/4", 3/8", 1/2"	4

M
330x250x70 mm

46PCS 1/4" SOCKET SET

- 21pcs socket bits: S2 material of bits Torx: T10, T15, T20, T25, T30, T40 Phillips: PH1, PH2, PH3 Slot: 4, 5.5, 6.5mm Pozzi: PZ1, PZ2, PZ3 Hex: 2, 2.5, 3, 4, 5, 6mm
- 1pc two-component ergonomic ratchet handle, CrV, quick release
- 13pcs metric CrV sockets: 4, 4.5, 5, 5.5, 6, 7, 8, 9, 10, 11, 12, 13, 14mm
- 1pc CrV sliding bar
- 1pc CrV screwdriver handle
- 1pc CrV universal joint
- 2pcs CrV extension bar: 50, 100mm
- 1pc CrV adaptor: 25mm
- 1pc CrV flexible bar: 150mm
- 4pcs CrV hex keys: 1.27, 1.5, 2.0, 2.5mm
- Packing: blow mould case



1/4"

engineered
to
get the job done

STOCK NO.	SIZE	QTY./CARTON
15138	1/4"	10

S
260x170x50 mm

60PCS TOOL SET

• Contains:



Toolbox 5 tray; 495x200x290mm



1/2" socket 6 point; CrV 50BV30;
8, 10, 11, 12, 13, 14, 15, 16, 17, 18,
19, 20, 21, 22, 24, 27, 30, 32mm



1/2" Reversible Ratchet; 45T; CrMo



1/2" Universal joint ; CrV



Water pump pliers 250mm/10"



Locking pliers 250mm; CrV



Combination spanner; CrV;



8,10, 11, 12, 13, 14, 15, 16, 17, 18,
19, 22, 24mm



Screwdriver; CrV;
SL3.0 x 75mm, SL5.5 x 100mm,
SL6.5 x 150mm, SL8.0 x 150mm
PH1 x 100mm, PH2 x 150mm, PH3 x 150mm



Comination pliers: 180mm/7"



Long nose pliers: 160mm/6"



Diagonal cutter pliers: 160mm/6"



9pcs ball point long arm hex key set; CrV;
1.5-2-2.5-3-4-5-6-8-10mm



1/2" extension bar 125mm; CrV



1/2" extension bar 250mm; CrV



1/2" 3 way adaptor; CrV



1/2" Spark plug socket 16mm; CrV



1/2" Spark plug socket 21mm; CrV

• Packing: color box

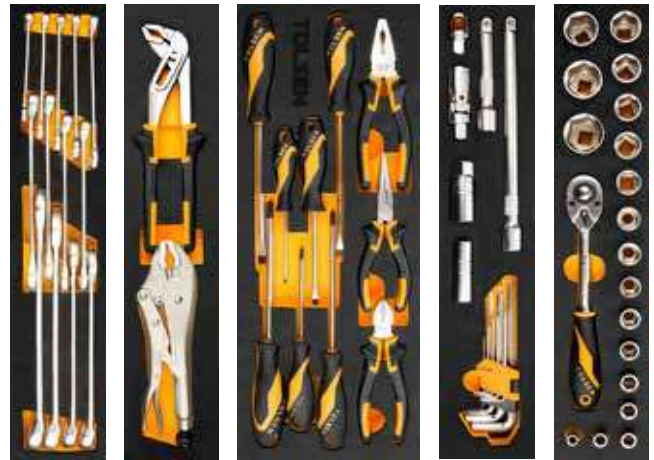

engineered
to
get the job done



STOCK NO.	QTY./CARTON
85401	1

26PCS TOOL SET

• Contains:

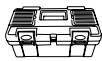

Heavy duty plastic tool box;
17" (420x230x190mm)



Combination pliers; 180mm, 7"



Machinist hammer; 300g



Snap-off blade knife; 18mm



5pcs combination spanners set;
8/10/13/17/19 mm



9pcs long arm hex key set;
1.5/2/2.5/3/4/5/6/8/10 mm



Screwdriver; CrV; SL3.0 x 75mm,
SL5.5 x 100mm, SL6.5 x 150mm,
PH0 x 75mm, PH1 x 100mm,
PH2 x 150mm



Measuring tape; 5m x 19mm, MIDII



Garden gloves; 10(XL)

• Packing: color sleeve

engineered
to
get the job done



STOCK NO.

QTY./CARTON

85361

4

9PCS HAND TOOL SET

• Contains:

- 1pcs combination pliers 7"/180mm
- 1pcs long nose pliers 6"/160mm
- 1pc adjustable wrench 8"/200mm
- 1pc mini claw hammer 8oz
- 1pc phillips screwdriver PH1x100mm
- 1pc slotted screwdriver 5.5x100mm
- 1pc snap-off blade knife 18x100mm
- 1pc measuring tape 3m x 16mm
- 1pc voltage tester 3x140mm

• Packing: canvas bag with color paper

NEW



STOCK NO.

QTY./CARTON

85300

10

3PCS TOOL SET

• Contains:

- 1pc combination pliers:
180mm, 7", nickel plated
 - 1pc water pump pliers:
250mm, 10", nickel plated
 - 1pc adjustable wrench:
200mm, 8", chrome finish
- Drop forged special tool steel
• Packing: double blister



STOCK NO.

QTY./CARTON

10403

16

9PCS HAND TOOL SET

• Contains:

- 1pc measuring tape: 3M/10ft x 16mm
- 2pcs screwdrivers: SL5.5x100mm, PH1x100mm
- 1pc adjustable wrench: 200mm/8"
- 1pc combination pliers: 180mm/7"
- 1pc diagonal cutting pliers: 160mm/6"
- 1pc snap-off blade knife
- 1pc voltage tester: 3x140mm
- 1pc PVC insulating tape: 19mm x 10yards

• Packing: canvas bag



STOCK NO.

QTY./CARTON

85301

10



HOLDING TOOLS



COMBINATION PLIERS

- Drop forged special tool steel, nickel plated
- Two-component plastic handle
- Packing: blister card

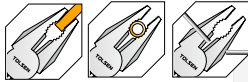

STOCK NO.	SIZE	QTY./CARTON
10000	160mm,6"	48
10001	180mm,7"	48
10002	200mm,8"	48

DIAGONAL CUTTING PLIERS

- Drop forged special tool steel, nickel plated
- Two-component plastic handle
- Packing: blister card



STOCK NO.	SIZE	QTY./CARTON
10003	160mm,6"	48
10004	180mm,7"	48

LONG NOSE PLIERS

- Drop forged special tool steel, nickel plated
- Two-component plastic handle
- Packing: blister card



STOCK NO.	SIZE	QTY./CARTON
10006	160mm,6"	48
10007	200mm,8"	48

BENT NOSE PLIERS

- Drop forged special tool steel, nickel plated
- Two-component plastic handle
- Packing: blister card



STOCK NO.	SIZE	QTY./CARTON
10008	160mm,6"	48

WIRE STRIPPING PLIERS

- Drop forged special tool steel, nickel plated
- Two-component plastic handle
- Packing: blister card



STOCK NO.	SIZE	QTY./CARTON
10013	160mm,6"	48

WATER PUMP PLIERS

- Drop forged special tool steel, nickel plated
- Two-component plastic handle
- Packing: blister card



STOCK NO.	SIZE	QTY./CARTON
10014	250mm,10"	36

3PCS PLIERS SET

- 1pc combination pliers 7"
- 1pc diagonal cutting pliers 6"
- 1pc long nose pliers 6"
- Drop forged special tool steel, nickel plated
- Two-component plastic handle
- Packing: double blister



STOCK NO.	SIZE	QTY./CARTON
10400		20

COMBINATION PLIERS

- CrV, black finish
- Two-component plastic handle
- Packing: double blister



GRIPPro
series



STOCK NO.	SIZE	QTY./CARTON
10015	160mm,6"	36
10016	180mm,7"	36
10017	200mm,8"	36

INDUSTRIAL

DIAGONAL CUTTING PLIERS

- CrV, black finish
- Two-component plastic handle
- Packing: double blister



GRIPPro series



STOCK NO.	SIZE	QTY./CARTON
10018	160mm,6"	36
10019	180mm,7"	36

LONG NOSE PLIERS

- CrV, black finish
- Two-component plastic handle
- Packing: double blister



GRIPPro series



STOCK NO.	SIZE	QTY./CARTON
10021	160mm,6"	36
10022	200mm,8"	36

BENT NOSE PLIERS

- CrV, black finish
- Two-component plastic handle
- Packing: double blister



GRIPPro series



STOCK NO.	SIZE	QTY./CARTON
10023	160mm,6"	36

WIRE STRIPPING PLIERS

- CrV, black finish
- Two-component plastic handle
- Packing: double blister



GRIPPro series



STOCK NO.	SIZE	QTY./CARTON
10028	160mm,6"	36

WATER PUMP PLIERS

- CrV, black finish
- Two-component plastic handle
- Packing: double blister



GRIPPro series



STOCK NO.	SIZE	QTY./CARTON
10029	250mm,10"	36

QUICK-RELEASE WATER PUMP PLIERS

- CrV, black finish
- Dipped handle
- Packing: PP card with color box



STOCK NO.	SIZE	MAX JAWS OPENING	QTY./CARTON
10329	10"	34mm	36
10330	12"	44mm	36

3PCS PLIERS SET

- 1pc 8" Combination pliers
- 1pc 6" Long nose pliers
- 1pc 6" Diagonal cutting pliers
- CrV, black finish and polish
- Two-component plastic handle
- Packing: double blister



GRIPPro series



STOCK NO.	SIZE	QTY./CARTON
10410		20

HIGH LEVERAGE SIDE CUTTING PLIER W/ FISH TAPE PULLER & CRIMPER

- Made of chrome vanadium steel
- Cushioned grip, comfortable handles
- High-leverage design for 47% greater cutting and gripping power
- Induction-hardened cutting knives for long life. use for cutting bolts, nails, and many gauges of wire including high strength wire
- Fish tape pulling, pulls flat steel fish tape without damaging the tape
- Connector crimping, use for most hardened wire
- Crimps connectors, lugs and terminals
- Packing: double blister



GRIPPro series

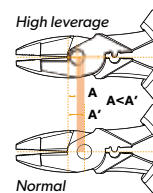

47% LABOR SAVING

STOCK NO.	SIZE	CUTTER LENGTH	QTY./CARTON
10305	240mm, 9-1/2"	19.05mm, 3/4"	30

COMBINATION PLIERS

- Drop forged special tool steel
- Fine polished surface
- Full body with heat treatment
- Separately induction hardened cutting edges with higher hardness, improve product life
- Bi-color dipped non-slip handle
- Packing: double blister

NEW



STOCK NO.	SIZE	QTY./CARTON
10270	160mm, 6"	48
10272	200mm, 8"	48

DIAGONAL CUTTING PLIERS

- Drop forged special tool steel
- Fine polished surface
- Full body with heat treatment
- Separately induction hardened cutting edges with higher hardness, improve product life
- Bi-color dipped non-slip handle
- Packing: double blister

NEW



STOCK NO.	SIZE	QTY./CARTON
10274	160mm, 6"	48
10276	190mm, 7.5"	48

LONG NOSE PLIERS

- Drop forged special tool steel
- Fine polished surface
- Full body with heat treatment
- Separately induction hardened cutting edges with higher hardness, improve product life
- Bi-color dipped non-slip handle
- Packing: double blister

NEW



STOCK NO.	SIZE	QTY./CARTON
10278	160mm, 6"	48
10280	200mm, 8"	48

BENT NOSE PLIERS

- Drop forged special tool steel
- Fine polished surface
- Full body with heat treatment
- Separately induction hardened cutting edges with higher hardness, improve product life
- Bi-color dipped non-slip handle
- Packing: double blister

NEW



STOCK NO.	SIZE	QTY./CARTON
10282	160mm, 6"	48
10284	200mm, 8"	48

HIGH LEVERAGE DIAGONAL CUTTING PLIERS

- Drop forged special tool steel, black finish
- Dipped handle
- Packing: double blister



45%
LABOR SAVING

STOCK NO.	SIZE	QTY./CARTON
10299	180mm, 7"	36
10300	200mm, 8"	36

HIGH LEVERAGE COMBINATION PLIERS

- Drop forged special tool steel Dipped handle
- Fine polished surface
- Bi-color dipped handle
- Packing: half blister



45%
LABOR SAVING

STOCK NO.	SIZE	QTY./CARTON
10304	240mm, 9-1/2"	30

GROOVE JOINT PLIERS

- Groove structure provides more durable
- Large opening adjustment to accommodate all shapes
- Drop forged special tool steel hardened and tempered
- Bi-color dipped non-slip handle
- Packing: PP card

NEW



STOCK NO.	SIZE	QTY./CARTON
10323	250mm, 10"	24
10326	400mm, 16"	16

MINI COMBINATION PLIERS

- Drop forged special tool steel, black finish
- Dipped handle
- Packing: blister card



STOCK NO.	SIZE	QTY./CARTON
10030	115mm, 4.5"	72

MINI LONG NOSE PLIERS

- Drop forged special tool steel, black finish
- Dipped handle
- Packing: blister card



STOCK NO.	SIZE	QTY./CARTON
10031	115mm, 4.5"	72

MINI DIAGONAL CUTTING PLIERS

- Drop forged special tool steel, black finish
- Dipped handle
- Packing: blister card



STOCK NO.	SIZE	QTY./CARTON
10033	115mm, 4.5"	72

3PCS MINI PLIERS SET

- Drop forged special tool steel, black finish
- Dipped handle
- Packing: blister card



STOCK NO.	SIZE	QTY./CARTON
10038	115mm, 4.5"	48

TOWER PINCER

- Drop forged high quality tool steel, black finish
- Dipped handle
- Packing: PP card



STOCK NO.	SIZE	QTY./CARTON
10039	200mm, 8"	36
10040	230mm, 9"	36
10041	250mm, 10"	36
10042	280mm, 11"	30

INDUSTRIAL

END CUTTING PINCER

- Drop forged high quality tool steel, black finish
- Dipped handle
- Packing: PP card



INDUSTRIAL

STOCK NO.	SIZE	QTY./CARTON
10043	160mm,6"	36
10044	180mm,7"	36
10345	200mm,8"	36

CARPENTER'S PINCER

- Drop forged high quality tool steel, black finish
- Dipped handle
- Packing: PP card



INDUSTRIAL

STOCK NO.	SIZE	QTY./CARTON
10045	200mm,8"	36

SLIP JOINT PLIERS

- Drop forged special tool steel
- Polish finished
- Dipped handle
- Packing: PP card



STOCK NO.	SIZE	QTY./CARTON
10311	160mm,6"	48
10313	200mm,8"	48
10314	250mm,10"	48

SLIP JOINT PLIERS

- Drop forged special tool steel
- Full body with heat treatment
- Black finished and fine polished surface
- Clamping adjustment
- Two-component plastic handle
- Packing: PP card



INDUSTRIAL

STOCK NO.	SIZE	QTY./CARTON
10315	160mm, 6"	48
10316	200mm, 8"	48

WATER PUMP PLIERS

- Drop forged special tool steel
- Full body with heat treatment
- Black finished and fine polished surface
- 7 position groove joint adjustable head
- Two-component plastic handle
- Packing: PP card



INDUSTRIAL

STOCK NO.	SIZE	QTY./CARTON
10321	250mm, 10"	36
10322	300mm, 12"	24

STRAIGHT LONG NOSE PLIERS

- Drop forged special tool steel
- Black finished and fine polished surface
- Serrated jaws provides greater gripping power
- Two-component plastic handle
- Long reach design allows for greater access in tight, hard-to-reach areas
- Packing: PP card



INDUSTRIAL

STOCK NO.	SIZE	QTY./CARTON
10290	280mm,11"	48

45-DEGREE LONG NOSE PLIERS

- Drop forged special tool steel
- Black finished and fine polished surface
- Serrated jaws provides greater gripping power
- Two-component plastic handle
- Long reach design allows for greater access in tight, hard-to-reach areas
- Packing: PP card



INDUSTRIAL

STOCK NO.	SIZE	QTY./CARTON
10291	280mm,11"	48

90-DEGREE LONG NOSE PLIERS

- Drop forged special tool steel
- Black finished and fine polished surface
- Serrated jaws provides greater gripping power
- Two-component plastic handle
- Long reach design allows for greater access in tight, hard-to-reach areas
- Packing: pp card



INDUSTRIAL

STOCK NO.	SIZE	QTY./CARTON
10292	280mm,11"	48

LOCKING PLIERS

- Drop forged special tool steel
- Nickel plated
- HRC38-HRC45
- Packing: hang tag



STOCK NO.	SIZE	MAX JAWS OPENING	QTY./CARTON
10051	250mm,10"	50mm	36

LOCKING PLIERS

- Drop forged special tool steel
- Nickel plated
- HRC38-HRC45
- Packing: hang tag



STOCK NO.	SIZE	MAX JAWS OPENING	QTY./CARTON
10052	230mm,9"	65mm	36

LOCKING PLIERS

- CrV
- Nickel plated
- HRC52-HRC56
- Packing: PP hanger



STOCK NO.	SIZE	MAX JAWS OPENING	QTY./CARTON
10048	250mm,10"	50mm	36

LOCKING PLIERS

- CrV
- Nickel plated
- HRC52-HRC56
- Packing: PP hanger



STOCK NO.	SIZE	MAX JAWS OPENING	QTY./CARTON
10380 ^{NEW}	180mm, 7"	35mm	36
10049	250mm, 10"	50mm	36

LOCKING PLIERS

- CrV
- Nickel plated
- HRC52-HRC56
- Packing: PP hanger

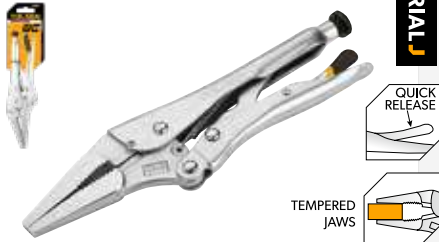

STOCK NO.	SIZE	MAX JAWS OPENING	QTY./ CARTON
10381 <small>NEW</small>	165mm, 6.5"	40mm	36
10053	230mm, 9"	65mm	36

INDUSTRIAL

LOCKING CLAMP WITH SWIVEL PADS

- Special tool steel
- Nickel plated
- Swivel pads: 28x28mm
- Packing: PP card

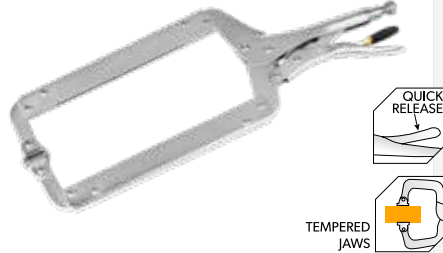

STOCK NO.	SIZE	CLAMPING LENGTH	MAX JAWS OPENING	QTY./ CARTON
10058	440mm, 17.5"	230mm	180mm	16

MINI BOLT CUTTER

- 65Mn blade
- Cutting edges induction quenched
- With comfortable pvc grips
- A lock in the end of handle
- Plastic handle
- Packing: blister card



STOCK NO.	SIZE	QTY./CARTON
10066	200mm, 8"	60

LOCKING PLIERS

- Special tool steel
- Nickel plated
- HRC52-HRC56
- Packing: PP hanger

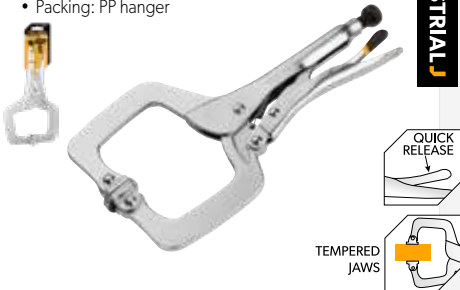

STOCK NO.	SIZE	MAX JAWS OPENING	QTY./ CARTON
10056	280mm, 11"	90mm	24

INDUSTRIAL

CHAIN CLAMP LOCKING PLIERS

- Special tool steel
- Nickel plated
- Packing: PP card



STOCK NO.	CHAIN LENGTH	QTY./CARTON
10050	460mm, 18"	20

PIPE WRENCH

- Mobile jaw drop-forged with high quality CrMo steel
- Aluminium alloy body
- Packing: hang tag with drawing box



INDUSTRIAL

SHEET METAL CLAMP

- Special tool steel
- Nickel plated
- Packing: PP hanger



STOCK NO.	SIZE	MAX JAWS OPENING	JAW WIDTH	THROAT DEPTH	QTY./ CARTON
10055	250mm, 10"	15 mm	100 mm	50 mm	24

BOLT CUTTER

- CrV blade, black finish
- Packing: drawing box with color label



STOCK NO.	SIZE	QTY./CARTON
10221	250mm, 10"	36
10222	300mm, 12"	24
10223	350mm, 14"	16
10224	450mm, 18"	8
10225	600mm, 24"	6
10226	900mm, 36"	4

PIPE WRENCH

- Mobile jaw drop-forged with high quality CrMo steel
- Dipped handle
- Packing: hang tag with drawing box



INDUSTRIAL

WELDING CLAMP

- "U" shaped
- Special tool steel
- Nickel plated
- Packing: PP hanger

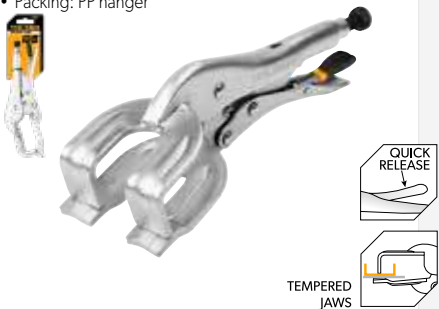

STOCK NO.	SIZE	MAX JAWS OPENING	CORNER HEIGHT	THROAT DEPTH	QTY./ CARTON
10057	230mm, 9"	45mm	30mm	60mm	24

BOLT CUTTER

- High quality tool steel blade, polished finish
- Packing: drawing box with color label



STOCK NO.	SIZE	QTY./CARTON
10241	300mm, 12"	24
10242	350mm, 14"	24
10243	450mm, 18"	12
10244	600mm, 24"	8
10245	750mm, 30"	5
10246	900mm, 36"	4
10247	1050mm, 42"	2

STOCK NO.	SIZE	MAX. CLAMPING DIA.	QTY./ CARTON
10067	200mm, 8"	27mm	36
10068	250mm, 10"	34mm	24
10069	300mm, 12"	43mm	12
10070	350mm, 14"	50mm	8
10071	450mm, 18"	60mm	6
10072	600mm, 24"	76mm	4
10073	900mm, 36"	105mm	2

PIPE WRENCH

- Mobile jaw drop-forged with high quality tool steel
- Packing: hang tag with drawing box



STOCK NO.	SIZE	QTY./CARTON
10231	200mm,8"	36
10232	250mm,10"	24
10233	300mm,12"	24
10234	350mm,14"	16
10235	450mm,18"	8
10236	600mm,24"	6
10237	900mm,36"	4

90° BENT NOSE PIPE WRENCH

- Mobile jaw drop-forged with high quality CrV steel
- Packing: color box



INDUSTRIAL



STOCK NO.	SIZE	MAX. CLAMPING DIA.	QTY./CARTON
10251	1"	40mm	24
10252	1.5"	55mm	12
10253	2"	67mm	8
10254	3"	103mm	4

45° BENT NOSE PIPE WRENCH

- Mobile jaw drop-forged with high quality CrV steel
- Packing: color box



INDUSTRIAL



STOCK NO.	SIZE	MAX. CLAMPING DIA.	QTY./CARTON
10256	1"	40mm	24
10257	1.5"	55mm	12
10258	2"	67mm	8
10259	3"	103mm	4

INTERNAL CIRCLIP PLIERS, STRAIGHT

- High quality tool steel
- Nickel plated
- Dipped handle
- Packing: blister card



STOCK NO.	SIZE	QTY./CARTON
10077	180mm,7"	60
10078	225mm,9"	60

INTERNAL CIRCLIP PLIERS, BENT

- High quality tool steel
- Nickel plated
- Dipped handle
- Packing: blister card



STOCK NO.	SIZE	QTY./CARTON
10082	180mm,7"	60
10083	225mm,9"	60

EXTERNAL CIRCLIP PLIERS, STRAIGHT

- High quality tool steel
- Nickel plated
- Dipped handle
- Packing: blister card



STOCK NO.	SIZE	QTY./CARTON
10087	180mm,7"	60
10088	225mm,9"	60

EXTERNAL CIRCLIP PLIERS, BENT

- High quality tool steel
- Nickel plated
- Dipped handle
- Packing: blister card



STOCK NO.	SIZE	QTY./CARTON
10092	180mm,7"	60
10093	225mm,9"	60

4PCS CIRCLIP PLIERS SET

- High quality tool steel
- Nickel plated
- Dipped handle
- Packing: double blister



STOCK NO.	SIZE	QTY./CARTON
10097	180mm,7"	20

4 IN 1 CIRCLIP PLIERS SET

- High quality tool steel
- Black finish
- Four in one combination design
- 2pcs straight head 180°
- 1pc bent head 90°
- 1pc bent head 45°
- For both internal and external use
- With comfortable plastic coated handles for easy grip
- Packing: blister card



STOCK NO.	SIZE	QTY./CARTON
10100	160mm,6"	48

FENCING PLIERS

- Drop forged special tool steel, heat treatment
- With hammer head
- Natural Polish
- Dipped handle
- Packing: blister card



STOCK NO.	SIZE	QTY./CARTON
10301	250mm,10"	24

BENCH VICE

- Swivel base with anvil
- Hardened and tempered jaws
- Packing: color label with color box



STOCK NO.	SIZE	QTY./CARTON
10107	50mm,2"	10

BENCH VICE

- Patent design
- Ultra large swivel base with anvil
- Hardened and tempered jaws
- Arc anvil design
- Vertical and horizontal clamping structure for cylinder shapes
- Fall-arrest design
- Packing: color box



INDUSTRIAL

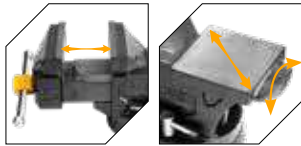

STOCK NO.	SIZE	CLAMPING FORCE	MAX. OPENING	ANVIL SIZE	NET WEIGHT	QTY./ CARTON
10804	4"	15KN	100mm	80x80mm	6.8kgs	1
10806	6"	20KN	150mm	90x90mm	11.5kgs	1
10808	8"	25KN	200mm	108x108mm	19.5kgs	1

QUICK RATCHET BAR CLAMP

- Hard plastic body
- Black finished bar
- Soft non-marking pads
- Packing: hang tag



STOCK NO.	SIZE	QTY./CARTON
10201	150mm,6"	32
10204	300mm,12"	24
10206	450mm,18"	18
10207	600mm,24"	18

4PCS QUICK RATCHET BAR CLAMP SET

- Hard plastic body
- Black finished bar
- Soft non-marking pads
- Packing: paper hanger



STOCK NO.	SIZE	QTY./CARTON
10209	2pcs 4" 2pcs 6"	10

CORNER CLAMP

- Material: aluminium alloy
- Powder coated
- Zinc plated thread bar
- Packing: hang tag



STOCK NO.	SIZE	QTY./CARTON
10210	75mm,3"	48

CORNER CLAMP

- Material: aluminium alloy
- Powder coated
- Zinc plated thread bar
- Packing: tied card



STOCK NO.	SIZE	QTY./CARTON
10218	75mm,3"	36

INDUSTRIAL

REVOLVING PUNCH PLIERS

- Punch hole sizes: 2, 2.5, 3, 3.5, 4, 4.5mm
- 40Cr, hardened chrome plated
- Packing: blister card



STOCK NO.	SIZE	QTY./CARTON
10101	220mm,9"	48

G-CLAMP

- Yellow powder coated bar
- Zinc plated thread bar
- Packing: color sleeve



STOCK NO.	SIZE	QTY./CARTON
10112	75mm,3"	48
10113	100mm,4"	30
10114	150mm,6"	16
10115	200mm,8"	12

F-CLAMP

- Nickel plated bar, Zinc plated thread bar
- Wooden handle
- Packing: color label



STOCK NO.	SIZE	THICKNESS AND WIDTH OF IRON RULER	QTY./ CARTON
10123	50x150mm	4.5x14.5mm	50
10125	50x250mm	4.5x14.5mm	30
10151	120x300mm	6.5x28.5mm	12
10153	120x500mm	6.5x28.5mm	10
10155	120x800mm	6.5x28.5mm	8
10156	120x1000mm	6.5x28.5mm	6

F-CLAMP

- Nickel plated bar
- Black finished thread bar
- Two-component plastic handle
- Packing: color label



STOCK NO.	SIZE	THICKNESS AND WIDTH OF IRON RULER	QTY./ CARTON
10161	50x150mm	5X15mm	20
10163	50x250mm	5X15mm	20
10189	120x300mm	8X30mm	10
10191	120x500mm	8X30mm	10
10193	120x800mm	8X30mm	8
10194	120x1000mm	8X30mm	6

SPRING CLAMP

- PP+Fiberglass mixture body
- PE jaws
- Packing: hang tag



STOCK NO.	SIZE	QTY./CARTON
10198	100mm,4"	100
10199	150mm,6"	100
10200	220mm,9"	100

QUICK RATCHET BAR CLAMP

- Hard plastic body
- Black finished bar
- Soft non-marking pads
- Packing: hang tag

NEW



STOCK NO.	SIZE	QTY./CARTON
10360	150mm,6"	36
10361	300mm,12"	36
10362	450mm,18"	24



MECHANICS TOOLS



ADJUSTABLE WRENCH

- Drop forged special tool steel
- Chrome finish
- Packing: polybag+hang tag



WITH METRIC & INCH SCALE

STOCK NO.	SIZE	MAX. JAWS OPENING	QTY./ CARTON
15001	150mm,6"	19mm, 3/4"	96
15002	200mm,8"	24mm, 15/16"	48
15003	250mm,10"	30mm, 1-3/16"	36
15004	300mm,12"	35mm, 1-3/8"	24
15005	375mm,15"	43mm, 1-11/16"	16
15006	450mm,18"	52mm, 2-1/16"	12

3PCS ADJUSTABLE WRENCH SET

- Drop forged special tool steel
- Chrome finish
- Packing: double blister



WITH METRIC & INCH SCALE

STOCK NO.	SIZE	MAX. JAWS OPENING	QTY./ CARTON
15007	150mm,6"	19mm, 3/4"	20
	200mm,8"	24mm, 15/16"	
	250mm,10"	30mm, 1-3/16"	

ALUMINIUM ADJUSTABLE WRENCH

- Aluminium die casting body for not damaging nuts
- 60% lighter than a normal standard adjustable wrench
- Extremely wide jaws
- Max. torque: 100 N.m
- Ideal for tighten nuts on the plated pipes such as faucets and trap pipes
- Packing: blister card

STOCK NO.	SIZE	MAX. JAWS OPENING	QTY./ CARTON
15303	205mm	10-68mm	48



WITH METRIC & INCH SCALE

ADJUSTABLE WRENCH

- Drop forged high quality tool steel
- Black finished and polished
- Two-component plastic handle
- Packing: double blister



GRIPPro series



WITH METRIC & INCH SCALE

STOCK NO.	SIZE	MAX. JAWS OPENING	QTY./ CARTON
15308	150mm,6"	19mm, 3/4"	60
15309	200mm,8"	24mm, 15/16"	36
15310	250mm,10"	30mm, 1-3/16"	24
15311	300mm,12"	35mm, 1-3/8"	18

STUBBY ADJUSTABLE WRENCH

- CrV
- Chrome finish
- Two-component plastic handle
- Packing: blister card



WITH METRIC & INCH SCALE

STOCK NO.	SIZE	MAX. JAWS OPENING	QTY./ CARTON
15280	165mm,6.5"	30mm	36

COMBINATION SPANNER

- Manufactured according DIN3113
- Chrome plated, matt nish
- packing:hang tag



DIN 3113

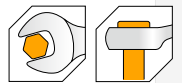

STOCK NO.	SIZE	QTY./CARTON
15814	6mm	240
15815	7mm	240
15816	8mm	240
15817	9mm	240
15818	10mm	240
15819	11mm	240
15820	12mm	240
15821	13mm	180
15822	14mm	120
15823	15mm	120
15824	16mm	120
15825	17mm	90
15826	18mm	90
15827	19mm	90
15828	20mm	90
15829	21mm	60
15830	22mm	60
15831	23mm	60
15832	24mm	48
15833	25mm	48
15834	26mm	48
15835	27mm	48
15836	28mm	30
15837	29mm	30
15838	30mm	30
15839	32mm	30
15840	35mm	20
15841	36mm	20
15842	38mm	20
15843	41mm	10

COMBINATION SPANNER

- Mirror finish
- Packing: flag label

INDUSTRIAL



INCH



STOCK NO.	SIZE	QTY./CARTON
15324	5/8"	120
15326	11/16"	90
15329	13/16"	60
15330	7/8"	60
15332	15/16"	48
15333	1"	48

COMBINATION SPANNER

- Mirror finish
- Packing: flag label

INDUSTRIAL



INCH



STOCK NO.	SIZE	QTY./CARTON
15461	1/4"	360
15462	5/16"	360
15463	3/8"	300
15464	7/16"	240
15465	1/2"	180
15466	9/16"	120
15467	5/8"	120
15468	11/16"	90
15469	3/4"	90
15470	13/16"	60
15471	7/8"	60
15472	15/16"	48
15473	1"	48
15474	1-1/16"	48
15475	1-1/8"	30
15476	1-1/4"	30
15477	1-3/8"	20
15478	1-1/2"	20
15479	1-5/8"	10

DOUBLE OPEN END SPANNER

- Manufactured according DIN3110
- Chrome plated, matt nish
- Packing:hang tag

INDUSTRIAL



DIN 3110



STOCK NO.	SIZE	QTY./CARTON
15851	6x7mm	240
15852	8x9mm	240
15853	10x11mm	240
15854	12x13mm	240
15855	14x15mm	120
15856	16x17mm	120
15857	18x19mm	60
15858	20x22mm	60
15859	21x23mm	60
15860	24x27mm	30
15861	25x28mm	30
15862	30x32mm	30

DOUBLE RING SPANNER

- Manufactured according DIN838
- Chrome plated, satin finish
- Packing: flag label

INDUSTRIAL



DIN 838



STOCK NO.	SIZE	QTY./CARTON
15871	6x7mm	240
15872	8x9mm	240
15873	10x11mm	180
15874	12x13mm	180
15875	14x15mm	120
15876	16x17mm	120
15877	18x19mm	60
15878	20x22mm	60
15879	21x23mm	60
15880	24x27mm	30
15881	25x28mm	30
15882	30x32mm	30

6PCS SAE COMBINATION SPANNERS SET

- Mirror finish
- Packing: Steel buckle



INCH

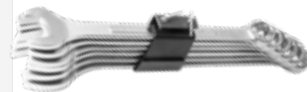

STOCK NO.	SIZE	QTY./CARTON
15380	1-3/8", 1-1/2", 1-5/8", 1-3/4", 1-7/8", 2"	2

5PCS COMBINATION SPANNER SET

- Manufactured according DIN3113
- Chrome plated, matt nish
- Packing: plastic hanger

INDUSTRIAL



STOCK NO.	SIZE	QTY./CARTON
15886	8/10/13/17/19mm	24

8PCS COMBINATION SPANNER SET

- Manufactured according DIN3113
- Chrome plated, matt nish
- Packing: plastic hanger

INDUSTRIAL



STOCK NO.	SIZE	QTY./CARTON
15887	8/10/12/13/14/15/17/19mm	12

12PCS COMBINATION SPANNER SET

- Manufactured according DIN3113
- Chrome plated, matt nish
- Packing: plastic hanger

INDUSTRIAL



STOCK NO.	SIZE	QTY./CARTON
15888	6/7/8/9/10/11/12/13/14/17/19/22mm	12

8PCS COMBINATION SPANNER SET (INCH)

- Mirror finish
- Packing: plastic hanger

INDUSTRIAL



STOCK NO.	SIZE	QTY./CARTON
15486	5/16", 3/8", 7/16", 1/2", 9/16", 5/8", 11/16", 3/4"	12

12PCS COMBINATION SPANNER SET (INCH)

- Mirror finish
- Packing: plastic hanger

INDUSTRIAL



STOCK NO.	SIZE	QTY./CARTON
15487	1/4", 5/16", 3/8", 7/16", 1/2", 9/16", 5/8", 11/16", 3/4", 13/16", 7/8", 15/16"	10

14PCS COMBINATION SPANNER SET

- Manufactured according DIN3113
- Chrome plated, satin finish
- Packing: pouch

INDUSTRIAL



STOCK NO.	SIZE	QTY./CARTON
15889	6, 7, 8, 10, 12, 13, 14, 17, 19, 22, 24, 27, 30, 32 mm	4

8PCS DOUBLE OPEN END SPANNER SET

- Manufactured according DIN3110
- Chrome plated, satin finish
- Packing: pouch

INDUSTRIAL



STOCK NO.	SIZE	QTY./CARTON
15891	6x7, 8x9, 10x11, 12x13, 14x15, 16x17, 18x19, 20x22mm	12

12PCS DOUBLE OPEN END SPANNER SET

- Manufactured according DIN3110
- Chrome plated, satin finish
- Packing: pouch



DIN 3110



STOCK NO.	SIZE	QTY./CARTON
15892	6x7,8x9,10x11,12x13,14x15,16x17,18x19,20x22,21x23,24x27,25x28,30x32mm	4

8PCS DOUBLE RING SPANNER SET

- Manufactured according DIN838
- Chrome plated, satin finish
- Packing: pouch



DIN 838



STOCK NO.	SIZE	QTY./CARTON
15895	6x7, 8x9, 10x11, 12x13, 14x15, 16x17, 18x19, 20x22mm	12

12PCS DOUBLE RING SPANNER SET

- Manufactured according DIN838
- Chrome plated, satin finish
- Packing: pouch



DIN 838



STOCK NO.	SIZE	QTY./CARTON
15896	6x7,8x9,10x11,12x13,14x15,16x17,18x19,20x22,21x23,24x27,25x28,30x32mm	4

INDUSTRIAL

SCAFFOLD WRENCH

- Special tool steel body
- CrV socket with 12 points
- Black finished
- Packing: hang tag



INDUSTRIAL

STOCK NO.	SIZE	QTY./CARTON
15292	17 x 19mm	32
15293	17 x 21mm	32
15295	19 x 21mm	32
15296	19 x 22mm	32
15297	19 x 24mm	24

RING SLOGGING WRENCH

- Heavy duty enabling the use of great force and striking.
- Slogging box end spanner wrench, used with a sledge hammer to tighten large bolts and nuts
- Handy for tight spaces when there is not enough room for large wrenches and great on frozen bolts
- Ideal for , Garage Workshop, Miners, Metal/Wood Workers, Builders, Car Mechanics, Hobbyists, and DIY Enthusiasts, Professionals etc.

NEW



STOCK NO.	SIZE	QTY./CARTON
17056	36mm	20
17057	41mm	12
17058	46mm	12
17059	50mm	10

OPEN ENDED SLOGGING WRENCH

- Heavy duty enabling the use of great force and striking.
- Slogging box open ended spanner wrench, used with a sledge hammer to tighten large bolts and nuts
- Handy for tight spaces when there is not enough room for large wrenches and great on frozen bolts
- Ideal for , Garage Workshop, Miners, Metal/Wood Workers, Builders, Car Mechanics, Hobbyists, and DIY Enthusiasts, Professionals etc.

NEW



STOCK NO.	SIZE	QTY./CARTON
17086	36mm	20
17087	41mm	12
17088	46mm	12
17089	50mm	10

FIXED COMBINATION RATCHET SPANNER

- Chrome plated, satin finish
- Packing: color box

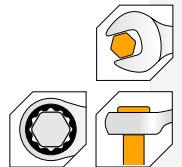

STOCK NO.	SIZE	QTY./CARTON
15204	8mm	200
15205	9mm	200
15206	10mm	200
15207	11mm	200
15208	12mm	100
15209	13mm	100
15210	14mm	100
15211	15mm	100
15212	16mm	100
15213	17mm	100
15214	18mm	50
15215	19mm	50
15216	20mm	50
15217	21mm	50
15218	22mm	50
15219	23mm	50
15220	24mm	50
15221	25mm	50
15223	27mm	40
15226	30mm	24
15228	32mm	16

FIXED COMBINATION RATCHET SPANNER

- Chrome plated, mirror finish
- Packing: color box

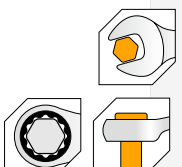

STOCK NO.	SIZE	QTY./CARTON
15401	5/16"	200
15404	1/2"	100
15405	9/16"	100
15410	7/8"	50
15412	1"	50

INDUSTRIAL

7PCS FIXED HEAD COMBINATION RATCHET SPANNER SET

- Chrome plated, satin finish
- Packing: plastic hanger with color label

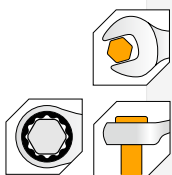

STOCK NO.	SIZE	QTY./CARTON
15229	8, 10, 12, 13, 14, 17, 19mm	20

FLEXIBLE HEAD COMBINATION RATCHET SPANNER

- Chrome plated, satin finish
- Packing: plastic hanger with color label

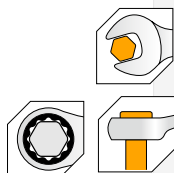

STOCK NO.	SIZE	QTY./CARTON
15234	8mm	100
15235	9mm	100
15236	10mm	100
15237	11mm	100
15238	12mm	100
15239	13mm	100
15240	14mm	100
15241	15mm	80
15242	16mm	80
15243	17mm	80
15244	18mm	50
15245	19mm	50
15246	20mm	50
15247	21mm	50
15248	22mm	40
15249	23mm	40
15250	24mm	40

7PCS FLEXIBLE HEAD COMBINATION RATCHET SPANNER SET

- Chrome plated, satin finish
- Packing: plastic hanger with color label

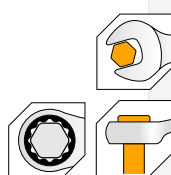

STOCK NO.	SIZE	QTY./CARTON
15259	8, 10, 12, 13, 14, 17, 19mm	20

DOUBLE END SWIVEL HEAD SOCKET WRENCH

- Chrome plated, satin finish
- Packing: plastic hanger with color label

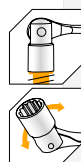

STOCK NO.	SIZE	QTY./CARTON
17021	8x9mm	96
17022	10x11mm	96
17023	12x13mm	72
17024	14x15mm	60
17025	16x18mm	48
17026	17x19mm	48

UNIVERSAL WRENCH

- Special tool steel
- Chrome finished surface
- Two-component plastic handle
- Packing: blister card



STOCK NO.	SIZE	QTY./CARTON
15282	9-32mm	24

CROSS RIM WRENCH

- Powder coated
- Cross design provides extra leverage and torque
- Packing: plastic hanger



STOCK NO.	SIZE	QTY./CARTON
15079	14" 17x19x21x23 mm	12

L-TYPE WRENCH

- Drop forged special tool steel, heat treated
- Mirror polished, chrome finish
- Packing: flag label

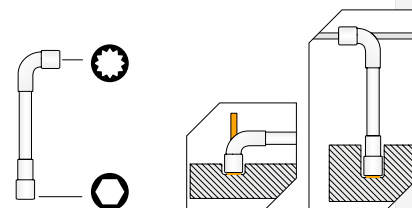

STOCK NO.	SIZE	QTY./CARTON
15087	8mm	120
15089	10mm	100
15091	12mm	60
15092	13mm	60
15093	14mm	60
15096	17mm	40
15098	19mm	30

9PCS L-TYPE WRENCH SET

- Material: Cr-V
- Heat treated
- Satin finish, chrome plated surface
- Packing: plastic hanger with color label

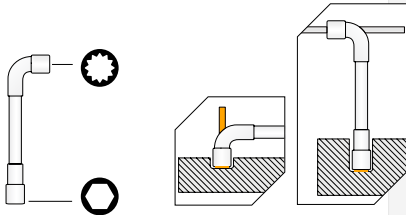

STOCK NO.	SIZE	QTY./CARTON
15086	7-8-10-11-12-13-14-17-19mm	10

5PCS L-TYPE WRENCH SET

- Material: Cr-V
- Size: 8-10-12-13-17mm
- Drop forged special tool steel with heat treated
- Stain finish, chrome plated surface
- Packing: plastic hanger with color label

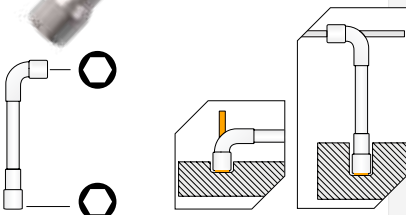

STOCK NO.	SIZE	QTY./CARTON
15085	8-10-12-13-17mm	16

INDUSTRIAL

T-TYPE WRENCH

- Chrome plated, satin finish
- Packing: paper hanger



STOCK NO.	SIZE	QTY./CARTON
15110	8x185x300mm	60
15111	9x185x300mm	60
15112	10x185x300mm	60
15113	12x185x300mm	60
15114	13x185x300mm	60
15115	14x185x300mm	60
15116	17x185x300mm	60
15117	19x185x300mm	60

REVERSIBLE RATCHET

- CrMo
- Satin finish
- Two-component ergonomic ratchet handle, quick release
- Packing: plastic hanger with color label

GRIPPro
series

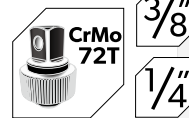

STOCK NO.	SIZE	QTY./CARTON
15118	1/4"	30
15119	3/8"	20
15120	1/2"	20

REVERSIBLE RATCHET

- CrMo
- Satin finish
- Two-component ratchet handle, 72T, CrV gear, quick release
- Ideal for narrow space
- Packing: plastic hanger

GRIPPro
series

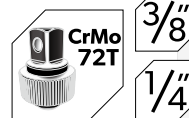

STOCK NO.	SIZE	QTY./CARTON
16118	1/4"	36
16119	3/8"	36
16120	1/2"	24

EXTENSION BAR

- CrV
- Satin finish
- Packing: plastic hanger with color label

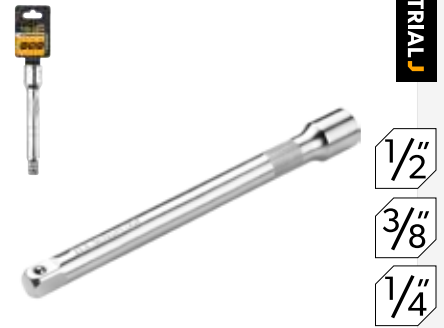

STOCK NO.	SIZE	QTY./CARTON
15121	1/4" x 50mm (2")	144
15122	1/4" x 100mm (4")	72
15123	3/8" x 75mm (3")	72
15124	3/8" x 150mm (6")	72
15127	1/2" x 125mm (5")	72
15128	1/2" x 250mm (10")	36

SLIDING BAR

- CrV
- Satin finish
- Packing: plastic hanger with color label

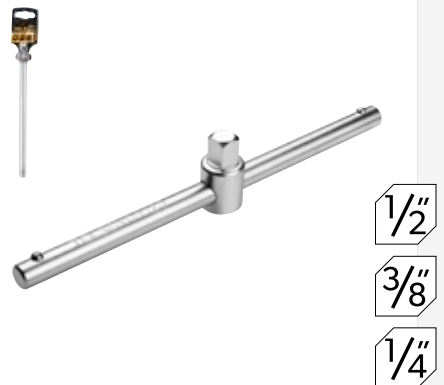

STOCK NO.	SIZE	QTY./CARTON
15129	1/4" x 115mm (4.5")	144
15130	3/8" x 160mm (6")	72
15131	1/2" x 250mm (10")	36

1/2 IN. DR. L HANDLE

- Material: Cr-V, Heat treatment
- Stain finish
- Manufactured in accordance with DIN3122
- Packing: plastic hanger with color label



STOCK NO.	SIZE	QTY./CARTON
16132	1/2" x 260mm	36

INDUSTRIAL

INDUSTRIAL

INDUSTRIAL

INDUSTRIAL

INDUSTRIAL

INDUSTRIAL

UNIVERSAL JOINT

- CrV
- Satin finish
- Packing: plastic hanger with color label



1/2"

3/8"

1/4"

STOCK NO.	SIZE	QTY./CARTON
15132	1/4" x 40mm	144
15133	3/8" x 56mm	72
15134	1/2" x 75mm	36

SPARK PLUG SOCKET

- CrV
- Satin finish
- Packing: plastic hanger with color label



1/2"

3/8"

STOCK NO.	SIZE	QTY./CARTON
15501	16mm, 3/8" x 5/8"	72
15502	21mm, 3/8" x 13/16"	72
15503	16mm, 1/2" x 5/8"	72
15504	21mm, 1/2" x 13/16"	72

SOCKET BIT

- CrV
- Satin finish
- Packing: plastic hanger with color label



1/2"

STOCK NO.	SIZE	QTY./CARTON
15552	1/2" x 3/16"	72
15553	1/2" x 1/4"	72
15554	1/2" x 5/16"	72
15555	1/2" x 3/8"	72
15557	1/2" x 1/2"	72

INDUSTRIAL

14PCS 1/4" RATCHET HANDLE WITH SOCKET SET

- 12pcs metric CrV sockets: 4,5,5.5,6,7,8,9,10,11,12,13,14mm
- 1pc CrV extension bar: 50mm
- 1pc two-component ergonomic ratchet handle, 72T, CrV, quick release
- Packing: plastic hanger with color label



1/4"

STOCK NO.	SIZE	QTY./CARTON
15150	1/4"	20

12PCS 3/8" RATCHET HANDLE WITH SOCKET SET

- 10pcs metric CrV sockets: 8,10,11,12,13,14,16,17,18,19mm
- 1pc CrV extension bar: 75mm
- 1pc two-component ergonomic ratchet handle, 72T, CrV, quick release
- Packing: plastic hanger with color label



3/8"

STOCK NO.	SIZE	QTY./CARTON
15151	3/8"	15

12PCS 1/2" RATCHET HANDLE WITH SOCKET SET

- 10pcs metric CrV sockets: 10,12,13,14,16,17,18,19,21,22mm
- 1pc CrV extension bar: 125mm
- 1pc two-component ergonomic ratchet handle, 72T, CrV, quick release
- Packing: plastic hanger with color label



1/2"

STOCK NO.	SIZE	QTY./CARTON
15152	1/2"	10

INDUSTRIAL

13PCS 1/4" RATCHET HANDLE WITH SOCKETS SET

- 11pcs 6pt SAE CrV sockets: 5/32", 3/16", 7/32", 1/4", 9/32", 5/16", 11/32", 3/8", 7/16", 1/2", 9/16"
- 1pc extension bar: 2"
- 1pc two-component ratchet handle, 72T, quick release
- Packing: plastic hanger with color label



1/4"

STOCK NO.	SIZE	QTY./CARTON
15390	1/4"	20

12PCS 3/8" RATCHET HANDLE WITH SOCKETS SET

- 10pcs 6pt SAE CrV sockets: 5/16", 3/8", 7/16", 1/2", 9/16", 5/8", 11/16", 3/4", 13/16", 7/8"
- 1pc extension bar: 3"
- 1pc two-component ratchet handle, 72T, quick release
- Packing: plastic hanger with color label



3/8"

STOCK NO.	SIZE	QTY./CARTON
15391	3/8"	15

12PCS 1/2" RATCHET HANDLE WITH SOCKETS SET

- 10pcs 6pt SAE CrV sockets: 3/8", 7/16", 1/2", 9/16", 5/8", 11/16", 3/4", 13/16", 7/8", 15/16"
- 1pc extension bar: 5"
- 1pc two-component ratchet handle, 72T, quick release
- Packing: plastic hanger with color label



1/2"

STOCK NO.	SIZE	QTY./CARTON
15392	1/2"	10

24PCS 1/2" DRIVE SOCKET SET

- 18pcs 1/2" CrV Dr. Sockets: 10,11,12,13,14,15,16,17,18,19,20,21,22,23,24,27,30,32mm
- 2pcs 1/2" Dr. extension bars: 5", 10"
- 1pc 1/2" Dr. sliding T bar 10"
- 1pc 1/2" Dr. universal joint
- 1pc 1/2" Dr. speeder handle
- 1pc 1/2" Dr. ratchet handle
- Packing: steel case

INDUSTRIAL



1/2"

STOCK NO.	SIZE	QTY./CARTON
15141	1/2"	4

FLEXIBLE HANDLE

- CrV
- Hardened and tempered
- Chrome plated
- Polished for corrosion protection
- Hinged joint head and spring-loaded ball bearing for secure socket holding
- Packing: plastic hanger

INDUSTRIAL



STOCK NO.	SIZE	QTY./CARTON
16127	1/2x15" (380mm)	24
16128	1/2x18" (460mm)	20

15PCS 3/4" DRIVE SOCKET SET

- 10pcs 3/4" CrV sockets: 22, 24, 27, 30, 32, 36, 38, 41, 46, 50mm;
- 1pc CrV sliding bar 450mm (18")
- 1pc CrV extension bar 200mm (8")
- 1pc CrV extension bar 400mm (16")
- 1pc CrV ratchet handle 500mm(20")
- 1pc CrV universal joint
- Packing: steel box with color sleeve

INDUSTRIAL



STOCK NO.	SIZE	QTY./CARTON
15148	3/4"	1

AUTOMATIC TORQUE WRENCH SET

- 1pc automatic torque wrench, 1/2", GS approved, ±4% accuracy deviation, torque range: 40-210Nm
- 1pc extension bar: 1/2"x125mm
- Packing: plastic box with color label + shrink

INDUSTRIAL



STOCK NO.	SIZE	QTY./CARTON
16010	1/2"	6sets



MICROMETER TORQUE WRENCH WITH REVERSIBLE RATCHET

- In accordance with DIN EN ISO 6789
- Release accuracy tolerance ±3% of scale value
- The reversible with square drive and integrated lever-change reversible ratchet function for controlled clockwise tightening
- Release signal when the value is reached
- Chrome-molybdenum steel oblate tube structure make a small cross-section, and easier to be used in narrow space
- Packing: color box

STOCK NO.	SIZE	TORQUE RANGE	L (mm)	LW (mm)	B (mm)	H (mm)	QTY./CARTON
19500	1/4"	1-5 Nm	240	172	29.34	13.07	12
19501	1/4"	2-10Nm	240	172	29.34	13.07	12
19505	3/8"	5-25 Nm	275	210	31.73	17.00	12
19506	3/8"	10-50 Nm	275	210	31.73	17.00	12
19507	3/8"	20-100 Nm	380	310	32.19	17.52	12
19510	1/2"	10-50 Nm	275	210	31.73	17.00	12
19511	1/2"	20-100 Nm	380	310	32.19	17.52	12
19512	1/2"	25-125 Nm	380	310	32.19	17.52	12
19513	1/2"	40-200 Nm	503	418	44.21	20.79	6
19514	1/2"	60-300 Nm	695	615	44.21	20.79	6
19515	1/2"	70-340 Nm	695	615	44.21	20.79	6
19520	3/4"	100-500 Nm	945	825	67.00	33.70	4
19521	3/4"	160-800 Nm	1225	1115	67.00	33.70	4
19522	3/4"	200-1000 Nm	1225	1115	67.00	33.70	4
19525	1"	100-500 Nm	945	825	67.00	33.70	4
19526	1"	160-800 Nm	1225	1115	67.00	33.70	4
19527	1"	200-1000 Nm	1225	1115	67.00	33.70	4



±3%
ACCURACY



From testing of accessories to final inspection, all of process we use professional and international well-known brand calibrating equipment, to ensure every torque wrench has guaranteed, stable and accurate torque output.

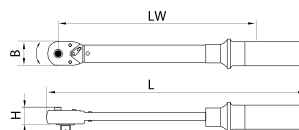

PREMIUM

TOOL SET

> PAGE 20-31



1/2" DRIVE SOCKET

- Material: 50BV30, heat treatment
- 1/2" Square driver with ball retaining groove
- Hand-operated, polished, chrome-plated
- Packing: plastic hanger with color label



INDUSTRIAL

INCH



1/2"

STOCK NO.	SIZE	QTY./CARTON
16537	5/16"	160
16538	3/8"	160
16539	7/16"	160
16540	1/2"	160
16541	9/16"	160
16542	5/8"	160
16543	11/16"	120
16544	3/4"	120
16546	7/8"	96
16548	1"	96
16549	1-1/16"	48
16551	1-3/16"	48
16552	1-1/4"	48

1/2" DRIVE SOCKET

- Material: 50BV30, heat treatment
- Acc. to DIN3124, ISO2725-1
- 1/2" Square driver with ball retaining groove
- Hand-operated, polished, chrome-plated
- Packing: plastic hanger with color label



INDUSTRIAL



1/2"

DIN

ISO

STOCK NO.	SIZE	QTY./CARTON
16508	8mm	160
16509	9mm	160
16510	10mm	160
16511	11mm	160
16512	12mm	160
16513	13mm	160
16514	14mm	160
16515	15mm	160
16516	16mm	160
16517	17mm	120
16518	18mm	120
16519	19mm	120
16520	20mm	120
16521	21mm	120
16522	22mm	96
16523	23mm	96
16524	24mm	96
16527	27mm	48
16530	30mm	48
16532	32mm	48

3/8" DRIVE SOCKET

- Material: 50BV30, Heat treatment
- Acc. to DIN3124, ISO2725-1
- 3/8" Square driver with ball retaining groove
- Hand-operated, polished, chrome-plated
- Packing: plastic hanger



INDUSTRIAL



3/8"

DIN

ISO

STOCK NO.	SIZE	QTY./CARTON
16308	8mm	160
16309	9mm	160
16310	10mm	160
16311	11mm	160
16312	12mm	160
16313	13mm	160
16314	14mm	160
16315	15mm	160
16316	16mm	160
16317	17mm	120
16318	18mm	120
16319	19mm	120

1/2" DRIVE DEEP SOCKET

- Material: 50BV30, heat treatment
- Acc. to DIN3124, ISO2725-1
- 1/2" Square driver with ball retaining groove
- Hand-operated, polished, chrome-plated
- Packing: plastic hanger with color label



INDUSTRIAL



1/2"

DIN

ISO

STOCK NO.	SIZE	QTY./CARTON
16558	8mm	160
16559	9mm	160
16560	10mm	160
16561	11mm	160
16562	12mm	160
16563	13mm	160
16564	14mm	160
16565	15mm	160
16566	16mm	160
16567	17mm	120
16568	18mm	120
16569	19mm	120
16570	20mm	120
16571	21mm	120
16572	22mm	96
16573	23mm	80
16574	24mm	80
16577	27mm	64
16580	30mm	48
16582	32mm	48

3/8" DRIVE DEEP SOCKET

- Material: 50BV30, heat treatment
- Acc. to DIN3124, ISO2725-1
- 3/8" Square driver with ball retaining groove
- Hand-operated, polished, chrome-plated
- Packing: plastic hanger with color label



INDUSTRIAL



3/8"

DIN

ISO

STOCK NO.	SIZE	QTY./CARTON
16358	8mm	160
16359	9mm	160
16360	10mm	160
16361	11mm	160
16362	12mm	160
16363	13mm	160
16364	14mm	160
16365	15mm	160
16366	16mm	160
16367	17mm	120
16368	18mm	120
16369	19mm	120

1/2" DRIVE IMPACT SOCKET

- Material: CrMo, heat treated
- 6 point socket
- Chemically molybdenum for corrosion protection
- Ideal for air, electric or manual impact wrenches
- Packing: plastic hanger with color label



INDUSTRIAL



1/2"

STOCK NO.	SIZE	QTY./CARTON
18208	8mm	120
18209	9mm	120
18210	10mm	120
18211	11mm	120
18212	12mm	120
18213	13mm	120
18214	14mm	120
18215	15mm	120
18216	16mm	120
18217	17mm	96
18218	18mm	96
18219	19mm	96
18220	20mm	96
18221	21mm	96
18222	22mm	80
18223	23mm	80
18224	24mm	80
18227	27mm	48
18230	30mm	48
18232	32mm	48

1/2" DRIVE DEEP IMPACT SOCKET

- Material: CrMo, heat treated
- 6 point socket
- Chemically molybdenum for corrosion protection
- Ideal for air, electric or manual impact wrenches
- Packing: plastic hanger with color label



INDUSTRIAL



1/2"

STOCK NO.	SIZE	QTY./CARTON
18258	8mm	120
18259	9mm	120
18260	10mm	120
18261	11mm	120
18262	12mm	120
18263	13mm	120
18264	14mm	120
18265	15mm	120
18266	16mm	120
18267	17mm	96
18268	18mm	96
18269	19mm	96
18270	20mm	96
18271	21mm	96
18272	22mm	80
18273	23mm	80
18274	24mm	80
18277	27mm	48
18280	30mm	48
18282	32mm	48

1/2" DRIVE IMPACT EXTENSION BAR

- Material: CrMo, heat treated
- Chemically molybdenum for corrosion protection
- Ideal for air, electric or manual impact wrenches
- Packing: plastic hanger with color label



INDUSTRIAL

1/2"

STOCK NO.	SIZE	QTY./CARTON
18285	3" / 75mm	100
18286	5" / 125mm	60
18287	10" / 250mm	36

1/2" DRIVE IMPACT UNIVERSAL JOINT

- Material: CrMo, heat treated
- Chemically molybdenum for corrosion protection
- Ideal for air, electric or manual impact wrenches
- Packing: plastic hanger with color label



INDUSTRIAL

1/2"

STOCK NO.	SIZE	QTY./CARTON
18288	1/2"	60

IMPACT ADAPTOR

- Material: CrMo, heat treated
- Chemically molybdenum for corrosion protection
- Ideal for air, electric or manual impact wrenches
- Packing: plastic hanger with color label



INDUSTRIAL

STOCK NO.	SIZE	QTY./CARTON
18289	1/2" F x 3/4" M	60

10PCS 1/2" DRIVE IMPACT SOCKET SET

- Material: CrMo, heat treated
- Chemically molybdenum for corrosion protection
- Ideal for air, electric or manual impact wrenches
- Packing: plastic hanger with color label



INDUSTRIAL

1/2"

STOCK NO.	SIZE	QTY./CARTON
18295	10,12,13,14,15,17,19,21,22,24mm	10

10PCS 1/2" DRIVE DEEP IMPACT SOCKET SET

- Material: CrMo, heat treated
- Chemically molybdenum for corrosion protection
- Ideal for air, electric or manual impact wrenches
- Packing: plastic hanger with color label



INDUSTRIAL

1/2"

STOCK NO.	SIZE	QTY./CARTON
18296	10,12,13,14,15,17,19,21,22,24mm	10

3PCS 1/2" DRIVE IMPACT SOCKET SET

- Material: CrMo, heat treated
- With PP protection cover
- Color oxidation treatment surface
17mm - blue, 19mm - gold, 21mm - red
- Ideal for air, electric or manual impact wrenches
- Packing: plastic case with color box



INDUSTRIAL

1/2"

STOCK NO.	SIZE	QTY./CARTON
15510	17,19,21mm	10

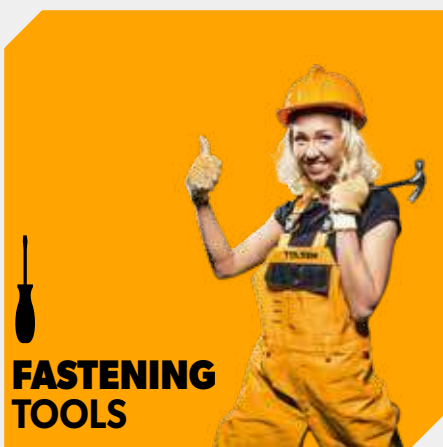

FASTENING TOOLS

SCREWDRIVER, STUBBY

- CrV
- Two-component comfortable grip
- Black finish magnetic tip
- Packing: plastic hanger with color box



GRIPPro series



STOCK NO.	SIZE	QTY./CARTON
20131	5.5 x 38mm	144
20132	6.5 x 38mm	144

SCREWDRIVER

- CrV
- Two-component comfortable grip
- Black finish magnetic tip
- Packing: plastic hanger with color box



GRIPPro series



STOCK NO.	SIZE	QTY./CARTON
20001	3.0x75mm	144
20002	4.0x100mm	144
20144	6.5x100mm	72
20003	5.5x100mm	144
20004	6.5x150mm	72
20005	8.0x150mm	72

SCREWDRIVER, STUBBY

- CrV
- Two-component comfortable grip
- Black finish magnetic tip
- Packing: plastic hanger with color box



GRIPPro series



STOCK NO.	SIZE	QTY./CARTON
20133	PH1 x 38mm	144
20134	PH2 x 38mm	144

SCREWDRIVER

- CrV
- Two-component comfortable grip
- Black finish magnetic tip
- Packing: plastic hanger with color box



GRIPPro series



STOCK NO.	SIZE	QTY./CARTON
20006	PH0x75mm	144
20007	PH1x100mm	144
20154	PH2x100mm	72
20008	PH2x150mm	72
20009	PH3X150mm	72

SCREWDRIVER

- CrV
- Two-component comfortable grip
- Black finish magnetic tip
- Packing: plastic hanger with color box



GRIPPro series



STOCK NO.	SIZE	QTY./CARTON
20010	PZ0x75mm	144
20011	PZ1x100mm	144
20164	PZ2x100mm	72
20012	PZ2x150mm	72
20013	PZ3X150mm	72

SCREWDRIVER

- CrV
- Two-component comfortable grip
- Black finish magnetic tip
- Packing: plastic hanger with color box



GRIPPro series



STOCK NO.	SIZE	QTY./CARTON
20166	T5x3.0x75mm	144
20167	T6x3.0x75mm	144
20168	T7x3.0x75mm	144
20169	T8x3.0x75mm	144
20170	T9x3.0x75mm	144
20171	T10x3.0x75mm	144
20172	T15x3.5x75mm	144
20173	T20x4.0x100mm	144
20174	T25x4.5x100mm	144
20175	T27x5.0x100mm	144
20176	T30x5.5x125mm	72
20177	T40x7.0x125mm	72

GO-THROUGH SCREWDRIVER, STUBBY

- CrV
- Two-component comfortable grip
- Black finish magnetic tip
- Packing: plastic hanger with color box



GRIPPro series



STOCK NO.	SIZE	QTY./CARTON
20138	1.2x6x38mm	96

GO-THROUGH SCREWDRIVER

- CrV
- Two-component comfortable grip
- Black finish magnetic tip
- Packing: plastic hanger



GRIPPro series



STOCK NO.	SIZE	QTY./CARTON
20111	1.0x5.5x75mm	72
20114	1.2x6.5x100mm	60
20115	1.2x6.5x150mm	60
20117	1.6x8x150mm	36
20119	1.6x10x200mm	36

GO-THROUGH SCREWDRIVER, STUBBY

- CrV
- Two-component comfortable grip
- Black finish magnetic tip
- Packing: plastic hanger with color box



STOCK NO.	SIZE	QTY./CARTON
20140	PH2x38mm	96

GO-THROUGH SCREWDRIVER

- CrV
- Two-component comfortable grip
- Black finish magnetic tip
- Packing: plastic hanger



STOCK NO.	SIZE	QTY./CARTON
20121	PH1x75mm	72
20122	PH1x100mm	72
20125	PH2x150mm	60
20127	PH3x150mm	36
20129	PH4x200mm	36

2PCS STUBBY SCREWDRIVER SET

- CrV
- Chrome plated, satin finish
- Black finish magnetic tip
- Packing: plastic hanger with color label



STOCK NO.	SIZE	QTY./CARTON
20181	6.5x38mm PH2x38mm	100

2PCS SCREWDRIVER SET

- CrV
- Chrome plated, satin finish
- Black finish magnetic tip
- Packing: plastic hanger with color label



STOCK NO.	SIZE	QTY./CARTON
20182	PH2x100mm 6.5x100mm	60

4PCS SCREWDRIVER SET

- CrV
- Two-component comfortable grip
- Black finished magnetic tip
- Packing: double blister



STOCK NO.	SIZE	QTY./CARTON
20179	4.0x100, 6.5x100, PH1x100, PH2x100	20

4PCS SCREWDRIVER SET

- CrV
- Two-component comfortable grip
- Black finish magnetic tip
- Packing: double blister



STOCK NO.	SIZE	QTY./CARTON
20180	6.5x100, PZ1x100, PZ2x100, S2x100	20

6PCS SCREWDRIVER SET

- CrV
- Two-component comfortable grip
- Black finish magnetic tip
- Packing: double blister



STOCK NO.	SIZE	QTY./CARTON
20014	5.5x100, 6.5x150; PH1x100, PH2x150; PZ1x100, PZ2x150	20

4PCS MINI PICK AND HOOK SET

- Point, 90°, 45°, Straight
- Cr-V blade
- Two component comfortable grip
- Designed to ease the removal of "O" rings, split pins, seals and bushes in various automotive and engineering applications
- Packing: double blister

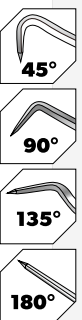

STOCK NO.	SIZE	QTY./CARTON
20190	3" ,36mm	48

SCREWDRIVER

- Ergonomic grip handle with anti-slip function
- Oil resistant, easy to clean
- Large hanging hole
- With rapid rotation design
- Anti-rolling function

GRIPPro
series



STOCK NO.	SIZE	QTY./CARTON
20701	3.0x75mm	144
20702	4.0x100mm	144
20703	5.5x100mm	144
20705	6.5x100mm	144
20707	6.5x150mm	72
20708	8.0x150mm	72

SCREWDRIVER

- Ergonomic grip handle with anti-slip function
- Oil resistant, easy to clean
- Large hanging hole
- With rapid rotation design
- Anti-rolling function

GRIPPro
series



STOCK NO.	SIZE	QTY./CARTON
20711	PH0x75mm	144
20712	PH1x100mm	144
20714	PH2x100mm	144
20716	PH2x150mm	144
20717	PH3x150mm	72

2PCS STUBBY SCREWDRIVER SET

- Ergonomic grip handle with anti-slip function
- Oil resistant, easy to clean
- Large hanging hole
- With rapid rotation design
- Anti-rolling function
- Packing: plastic hanger with color label



GRIPPro
series



STOCK NO.	SIZE	QTY./CARTON
20734	6.5X38mm PH2X38mm	100

2PCS SCREWDRIVER SET

- Ergonomic grip handle with anti-slip function
- Oil resistant, easy to clean
- Large hanging hole
- With rapid rotation design
- Anti-rolling function
- Packing: plastic hanger with color label



GRIPPro
series



STOCK NO.	SIZE	QTY./CARTON
20735	6.5X100mm PH2X100mm	60

4PCS SCREWDRIVER SET

- Ergonomic grip handle with anti-slip function
- Oil resistant, easy to clean
- Large hanging hole
- With rapid rotation design
- Anti-rolling function
- Packing: double blister



GRIPPro
series



STOCK NO.	SIZE	QTY./CARTON
20737	5.5x100mm, 6.5x150mm, PH1x100mm, PH2x150mm	30

6PCS SCREWDRIVER SET

- Ergonomic grip handle with anti-slip function
- Oil resistant, easy to clean
- Large hanging hole
- With rapid rotation design
- Anti-rolling function
- Packing: double blister



GRIPPro
series



STOCK NO.	SIZE	QTY./CARTON
20738	3.0x75mm, 5.5x100mm, 6.5x100mm, PH0x75mm, PH1x100mm, PH2X100mm	20

8PCS SCREWDRIVER SET

- Ergonomic grip handle with anti-slip function
- Oil resistant, easy to clean
- Large hanging hole
- With rapid rotation design
- Anti-rolling function
- Packing: double blister



GRIPPro
series



STOCK NO.	SIZE	QTY./CARTON
20739	3.0x75mm, 5.5x100mm 6.5x150mm, 6.5x38mm PH0x75mm, PH1x100mm PH2x150mm, PH2x38mm	20

10PCS SCREWDRIVER SET

- Ergonomic grip handle with anti-slip function
- Oil resistant, easy to clean
- Large hanging hole
- With rapid rotation design
- Anti-rolling function
- Packing: double blister



GRIPPro
series



STOCK NO.	SIZE	QTY./CARTON
20740	3.0x75mm, 5.5x100mm 6.5x150mm, 8.0x150mm, 6.5x38mm PH0x75mm, PH1x100mm PH2x100mm, PH3x150mm, PH2x38mm	12

6PCS PRECISION SCREWDRIVER SET

- CrV
- Ergonomic comfort-grip handle
- Packing: plastic box



STOCK NO.	SIZE	QTY./CARTON
20030	2x50mm, 2.5x50mm, 3.0x50mm; PH000x50mm, PH00x50mm, PH0x50mm	36

6PCS PRECISION SCREWDRIVER SET

- Packing: plastic box+color box



STOCK NO.	SIZE	QTY./CARTON
20031	1.4x0.5, 2.0x0.5, 2.4x0.6, 3.0x0.6; PH0,PH1	100

SCREWDRIVER MAGNETIZER

- Material:PP
- Packing: double blister

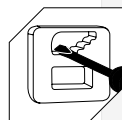

STOCK NO.	SIZE	QTY./CARTON
20032		96

19PCS SCREWDRIVER SET

- 7pcs screwdrivers Cr-V: Two-component comfortable grip SL6x38mm, 3.0x75mm, 5.5x100mm PH2x38mm, PH0x75mm, PH1x100mm, PH2x100mm
- 4pcs precision screwdrivers: Two-component comfortable grip SL2.0x50mm, 2.5x50mm, PH000x50mm, PH00x50mm
- 7pcs Cr-V bits 1/4"x25mm: SL4, SL6, PH1, PH2, T10, T15, T20
- 1pc nut screwdriver 1/4"x100mm
- Two-component comfortable grip
- Black finish magnetic tip
- With 1 pc plastic hanger
- Packing: double blister



STOCK NO.	SIZE	QTY./CARTON
20183		8

44PCS SCREWDRIVER SET

- Contains 17pcs screwdrivers Cr-V blade Two-component comfortable grip Black finish magnetic tip SL: 0.5x3.0x75mm, 0.8x4.0x100mm, 1.0x5.5x100mm, 1.2x6.5x100mm, 1.6x8.0x150mm PH: PH0x75mm, PH1x75mm, PH2x100mm, PH3x150mm PZ: PZ0x75mm, PZ1x75mm, PZ2x100mm, PZ3x150mm TORX: T25x100mm, T27x100mm, T30x125mm, T40x125mm
- 1pc nut screwdriver 1/4"x100mm
- 16pcs hex key Cr-V material Chrome plated 1.5, 2, 2.5, 3, 4, 5, 5.5, 6mm 1/16", 5/64", 3/32", 1/8", 5/32", 3/16", 7/32", 1/4"
- 10pcs Cr-V bits 1/4"x25mm Hex: 3, 4, 5, 6mm Torx: T7, T8, T9, T10, T15, T20
- All items are packed on a plastic display stand
- Packing: color box



STOCK NO.	SIZE	QTY./CARTON
20184		6

100PCS SCREWDRIVER SET

- 20pcs screwdrivers Cr-V blade Two-component comfortable grip Black finish magnetic tip SL: 3.0x75mm, 4.0x75mm, 5.5x100mm, 6.5x100mm, 8.0x150mm PH: PH0x75mm, PH1x100mm, PH2x100mm, PH3x150mm PZ: PZ0x75mm, PZ1x100mm, PZ2x100mm, PZ3x150mm TORX: T10x75mm, T15x75mm, T20x100mm, T25x100mm, T30x125mm SQUARE: S1x75mm, S2x100mm
- 1pc ratchet screwdriver, 72teeth, Two-component comfortable grip
- 8pcs precision screwdrivers Cr-V material Two-component comfortable grip Black finish magnetic tip SL: 2.0x50mm, 2.5x50mm PH: PH00x50mm, PH0x50mm TORX: T5x50mm, T6x50mm, T8x50mm, T9x50mm
- 2pcs 2-in-1 Z type screwdriver bits: SL5-PH1, SL6-PH2, Cr-V blade, 110mm
- 5pcs socket 38mm: 7, 8, 9, 10, 11mm
- 1pc CE approved voltage tester: 3x140mm
- 1pc Cr-V adaptor 60mm
- 60pcs Cr-V bits 1/4"x25mm SL: 2, 3, 4, 5, 5.5, 6mm PH: 3xPH0, 4xPH1, 4xPH2, 2xPH3 PZ: 3xPZ0, 4xPZ1, 4xPZ2, 2xPZ3 TORX: T10, T15, T20, T25, T30, T40 TORX with hole: T10, T15, T20, T25, T30, T40 HEX: H2, H2.5, H3, H4, H5, H5.5, H6 HEX with hole: H2, H2.5, H3, H4, H5, H5.5, H6 SQUARE: S1, S2
- 2pcs VDE screwdrivers, S2 blade SL: 4x100mm PH: PH1x80mm
- All items are packed on a plastic display stand
- Packing: color box



STOCK NO.	SIZE	QTY./CARTON
20185		4

7PCS GO-THROUGH SCREWDRIVER SET

- Cr-V
- SL1.0x4.5x90mm 1.0x5.5x100mm 1.2x7.0x125mm, PH1x80, PH2x100mm
- PZ1x80mm, PZ2x100mm
- Two-component comfortable grip
- Black finish magnetic tip
- With 1pc plastic hanger
- Packing: double blister

NEW



STOCK NO.	QTY./CARTON
20195	12



7PCS NUT SCREWDRIVER

- 7pcs Nut screwdriver
- Metric sizes: 6mm-7mm-8mm-9mm-10mm-11mm-12mm
- Blade length: 82mm
- Cr-V blade
- Two-component comfortable grip
- Packing: plastic hanger with color label



STOCK NO.	QTY./CARTON
20196	12



7PCS NUT SCREWDRIVER

- 7pcs Nut screwdriver
- SAE sizes: 3/16", 1/4", 5/16", 11/32", 3/8", 7/16", 1/2"
- Blade length: 3-1/4"
- Cr-V blade
- Two-component comfortable grip
- Packing: plastic hanger with color label



STOCK NO.	QTY./CARTON
20197	12

INCH



11PCS BIT SET

- Nut screwdriver 1/4" x 100mm
- 10pcs CrV bits: 1/4" x 25mm SL3, SL4, SL5, SL6 PH1, PH2, PH3 PZ1, PZ2, PZ3
- Packing: double blister



STOCK NO.	QTY./CARTON
20044	60



17PCS SOCKET AND BIT SET

- Nut screwdriver 1/4" x 100mm
- 10pcs CrV bits: 1/4" x 25mm: SL4, SL5, SL6 PH1, PH2, PH3 PZ1, PZ2, PZ3
- 1/4" socket adaptor
- 6pcs 1/4" sockets 5mm, 6mm, 7mm, 8mm, 9mm, 10mm
- Packing: double blister



STOCK NO.	QTY./CARTON
20045	60



7 IN 1 RATCHET DRIVER

- 1pc ratchet handle
- 7pcs 25mm bits: 4, 5, 6, PH0, PH1, PH2, PH3
- CrV
- Packing: double blister



STOCK NO.	SIZE	QTY./CARTON
20033		48



14 IN 1 RATCHET SCREWDRIVER

- 1pc ratchet screwdriver
- 1pc bits holder 60mm
- 12pcs bits (6.35x25mm) SL: 3, 4, 5, 6mm PH: PH0, PH1, PH2, PH3 TX: T10, T15, T20, T25
- Packing: double blister



STOCK NO.	SIZE	QTY./CARTON
20040		36



2 IN 1 SCREWDRIVER SET

- Two-way blade size: 6.35x130mm, PH2+SL6mm
- CrV
- With 1pc interchangeable handle
- Packing: double blister



STOCK NO.	SIZE	QTY./CARTON
20042		120



6 IN 1 SCREWDRIVER SET

- 2 pcs two-way CrV bits: 6.35x65mm, PH1+SL5 8.00x75mm, PH2+SL6
- Two-way hex bit holder: 6mm+8mm
- With 1pc interchangeable handle
- Packing: double blister



STOCK NO.	SIZE	QTY./CARTON
20043		60



26PCS BIT SET

- 1pc Ratchet screwdriver with with two-component comfortable grip, 72teeth
- 18pcs Cr-V bits 65mm PH0, PH1, PH2, PH3, PZ1, PZ2, PZ3, SL3, SL4, SL5, SL6, SL7, T10, T15, T20, T25, T27, T30
- 6pcs nut socket 1/4" x 38mm: 5mm, 6mm, 7mm, 8mm, 9mm, 10mm
- 1pc Cr-V bit holder 1/4" x 60mm
- Packing: canvas bag with double blister

NEW



STOCK NO.	SIZE	QTY./CARTON
20186		20



INDUSTRIAL

42PCS BIT & SOCKET SET

- 1pc ratchet screwdriver
- 16pcs bits (6.35X25mm):
SL: 3,4,5,6mm
PH: PH0, PH1, PH2, PH3
TX: T10, T15, T20, T25
HEX: H3, H4, H5, H6
- 1pc adaptor 25mm
- 1pc precision bits driver
- 1pc magnetic holder
- 12pcs precision bits (4x28mm)
SL: 2, 2.5, 3mm
PH: PH0, PH00, PH000,
TX: T5, T6, T7,
HEX: H1.3, H1.5, H2.0
- 9pcs 1/4" sockets:
4, 5, 6, 7, 8, 9, 10, 11, 12mm
- Packing: color sticker



STOCK NO.	QTY./CARTON
20041	20

26PCS BIT SET

- 1pc ratchet handle
- 1pc bit holder: 60mm
- 25mm CrV bits:
SL: 4, 5, 6, 7mm
PH: PH0, PH1, PH2, PH3
PZ: PZ0, PZ1, PZ2, PZ3
HEX: 2, 2.5, 3, 4, 5, 6mm
TX: T10, T15, T20, T25, T30, T40
- Packing: plastic box



STOCK NO.	SIZE	QTY./CARTON
20034		20

56PCS BIT & SOCKET SET

- 1pc Ratchet screwdriver with with two-component comfortable grip, 72teeth
- 21pcs Cr-V bits, H6x25mm
SL4, SL5, SL6
PH1, PH2, PH3
PZ1, PZ2, PZ3
H3, H4, H5, H6
T10, T15, T20, T25, T27, T30, T35, T40
- 20pcs Cr-V bits, H4x28mm
SL1.5, SL2, SL2.5, SL3.0
PH000, PH00, PH0
PZ000, PZ00, PZ0
T5, T6, T7, T8, T9, T10
H0.9, H1.3, H1.5, H2.0
- 9pcs 1/4" Sq. Dr. Cr-V sockets, 4, 5, 6, 7, 8, 9, 10, 11, 12mm
- 1pc Cr-V bit holder 1/4"x60mm
- 1pc precision bits driver
- 1pc extension bar for precision bits driver 75mm
- 1pc Adaptor 1/4"x25mm
- Packing: color label



STOCK NO.	QTY./CARTON
20187	12

38PCS BIT & SOCKET SET

- 9pcs 1/4" sockets: 5, 6, 7, 8, 9, 10, 11, 12, 13mm
- 25mm CrV bits:
SL:3, 4, 5, 6mm
PH: PH0, PH1, PH2, PH3
PZ: PZ0, PZ1, PZ2, PZ3
HEX: 2, 2.5, 3, 4, 5, 5.5, 6mm
TX: T10, T15, T20, T25, T27, T30, T40
- 1pc 3" extension Bar
- 1pc 1/4" socket adaptor
- 1pc 1/4" handle
- Packing: plastic box



STOCK NO.	SIZE	QTY./CARTON
20035		20

105PCS BIT SET

- 1pc Ratchet screwdriver with with two-component comfortable grip, 72teeth
- 1pc Cr-V bit adaptor 1/4"x26mm
- 1pc Cr-V bit holder 1/4"x60mm
- 1pc socket adaptor 1/4"x50mm
- 1pc socket adaptor 1/4"x25mm
- 100pcs Cr-V bits 1/4"x25mm
- 4pcs SL: 3, 4, 5, 6mm
- 11pcs PH: 2xPH0, 2xPH1, 5xPH2, 2xPH3
- 10pcs PZ: PZ0, 2xPZ1, 5xPZ2, 2xPZ3
- 13pcs Torx: T8, 2xT10, 2xT15, 2xT20, 2xT25, T27, T30, T40, T45
- 9pcs Hex: 1.5, 2, 2.5, 3, 4, 4.5, 5, 5.5, 6
- 10pcs Hex SAE: 1/16", 5/64", 3/32", 7/64", 1/8", 9/64", 5/32", 3/16", 7/32", 1/4"
- 3pcs M type: 5, 6, 8
- 4pcs Square: 0, 1, 2, 3
- 4pcs U type: 4-6-8-10
- 3pcs TORO type: 6, 8, 10
- 4pcs TRI type: 1, 2, 3, 4
- 9pcs Torx with holes: T8, T10, T15, T20, T25, T27, T30, T40, T45
- 12pcs Hex with holes: 2, 2.5, 3, 4, 5, 6, 5/64", 3/32", 7/64", 1/8", 9/64", 5/32"
- 3pcs C type: 1, 2, 3
- 1pcs Y type
- Packing: color label



STOCK NO.	QTY./CARTON
20188	12

41PCS BIT & SOCKET SET

- 1pc quick change T-handle
- 1pc 25mm CrV socket adaptor
- 1pc 140mm extension bar
- 6pcs sockets: 5, 6, 7, 8, 10, 12mm
- 32pcs 25mm CrV bits:
SL: 3, 4, 5, 6, 7mm
PH: 2XPH0, 2XPH1, 3XPH2, 2XPH3
PZ: PZ0, PZ1, PZ2, PZ3
HEX: 2, 3, 4, 5, 6mm
TX: T8, T9, T10, T15, T20, T25, T27, T30, T40
- Packing: plastic box



STOCK NO.	SIZE	QTY./CARTON
20036		20

8-IN-1 SCREWDRIVER SET

- SL: 3.0x60, 5.0x60, 6.0x60mm
- PH: PH0x60, PH1x60, PH2x60mm
- 1pc scratch awl 3x60mm
- 1pc tack remover 5x60mm
- 1pc handle
- Packing: plastic box



STOCK NO.	SIZE	QTY./CARTON
20039		48

2PCS SCREWDRIVER BIT SET

- S2 industrial steel , hardened and tempered
- Satin finished
- Packing: blister card



STOCK NO.	SIZE	QTY./CARTON
20202	SL0.5x4.0x25mm	320
20203	SL0.6x4.5x25mm	320
20205	SL0.8x5.5x25mm	320
20207	SL1.2x6.5x25mm	320

2PCS SCREWDRIVER BIT SET

- S2 industrial steel , hardened and tempered
- Satin finished
- Anti-slip tip
- Packing: blister card



STOCK NO.	SIZE	QTY./CARTON
20212	PH1x25mm	320
20213	PH2x25mm	320
20214	PH3x25mm	320

2PCS SCREWDRIVER BIT SET

- S2 industrial steel , hardened and tempered
- Satin finished
- Anti-slip tip
- Packing: blister card

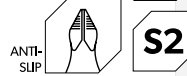

STOCK NO.	SIZE	QTY./CARTON
20217	PZ1x25mm	320
20218	PZ2x25mm	320
20219	PZ3x25mm	320

2PCS SCREWDRIVER BIT SET

- S2 industrial steel , hardened and tempered
- Satin finished
- Packing: blister card



STOCK NO.	SIZE	QTY./CARTON
20221	T10x25mm	320
20222	T15x25mm	320
20223	T20x25mm	320
20224	T25x25mm	320
20225	T27x25mm	320
20226	T30x25mm	320
20227	T40x25mm	320

2PCS SCREWDRIVER BIT SET

- S2 industrial steel , hardened and tempered
- Satin finished
- Packing: blister card



STOCK NO.	SIZE	QTY./CARTON
20233	H3x25mm	320
20234	H4x25mm	320
20235	H5x25mm	320
20236	H6x25mm	320

2PCS SCREWDRIVER BIT SET

- S2 industrial steel , hardened and tempered
- Satin finished
- Packing: blister card

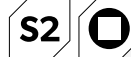

STOCK NO.	SIZE	QTY./CARTON
20238	S1x25mm	320
20239	S2x25mm	320
20240	S3x25mm	320

5PCS SCREWDRIVER BIT SET

- S2 industrial steel , hardened and tempered
- Satin finished
- Anti-slip tip
- Packing: blister card



STOCK NO.	SIZE	QTY./CARTON
20271	PH2x25mm	160

5PCS SCREWDRIVER BIT SET

- S2 industrial steel , hardened and tempered
- Satin finished
- Anti-slip tip
- Packing: blister card



STOCK NO.	SIZE	QTY./CARTON
20273	PZ2x25mm	160

5PCS SCREWDRIVER BIT SET

- S2 industrial steel , hardened and tempered
- Satin finished
- Packing: blister card



STOCK NO.	SIZE	QTY./CARTON
20276	T20x25mm	160
20277	T25x25mm	160
20279	T30x25mm	160

5PCS SCREWDRIVER BIT SET

- S2 industrial steel , hardened and tempered
- Satin finished
- Packing: blister card



STOCK NO.	SIZE	QTY./CARTON
20280	S2x25mm	160

5PCS SCREWDRIVER BIT SET

- S2 industrial steel , hardened and tempered
- Satin finished
- Packing: blister card



INDUSTRIAL



S2

STOCK NO.	SIZE	QTY./ CARTON
20290	9/64"-5/32"-3/26"-7/32"-1/4"	320

5PCS SCREWDRIVER BIT SET

- S2 industrial steel , hardened and tempered
- Satin finished
- Packing: blister card

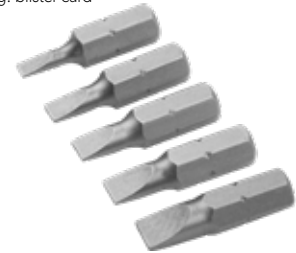

INDUSTRIAL



S2

STOCK NO.	SIZE	QTY./CARTON
20285	SL3.0-4.0-4.5-5-6.5x25mm	160

5PCS SCREWDRIVER BIT SET

- S2 industrial steel , hardened and tempered
- Satin finished
- Anti-slip tip
- Packing: blister card

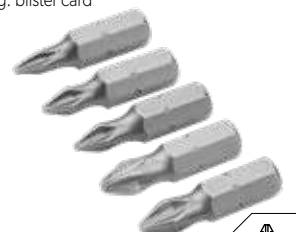

INDUSTRIAL



S2

STOCK NO.	SIZE	QTY./CARTON
20286	PH0-PH1-PH2-PH2-PH3x25mm	160

2PCS SCREWDRIVER BIT SET

- S2 industrial steel , hardened and tempered
- Satin finished
- Packing: blister card



INDUSTRIAL



S2

STOCK NO.	SIZE	QTY./CARTON
20302	SL0.5x4.0x50mm	320
20303	SL0.6x4.5x50mm	320
20305	SL0.8x5.5x50mm	320
20307	SL1.2x6.5x50mm	320

2PCS SCREWDRIVER BIT SET

- S2 industrial steel , hardened and tempered
- Satin finished
- Anti-slip surface
- Packing: blister card



INDUSTRIAL



S2



STOCK NO.	SIZE	QTY./CARTON
20312	PH1x50mm	320
20313	PH2x50mm	320
20314	PH3x50mm	320

2PCS SCREWDRIVER BIT SET

- S2 industrial steel , hardened and tempered
- Satin finished
- Anti-slip surface
- Packing: blister card



INDUSTRIAL



S2



STOCK NO.	SIZE	QTY./CARTON
20317	PZ1x50mm	320
20318	PZ2x50mm	320
20319	PZ3x50mm	320

2PCS SCREWDRIVER BIT SET

- S2 industrial steel , hardened and tempered
- Satin finished
- Packing: blister card



INDUSTRIAL



S2

STOCK NO.	SIZE	QTY./CARTON
20321	T10x50mm	320
20322	T15x50mm	320
20323	T20x50mm	320
20324	T25x50mm	320
20325	T27x50mm	320
20326	T30x50mm	320
20327	T40x50mm	320

2PCS SCREWDRIVER BIT SET

- S2 industrial steel , hardened and tempered
- Satin finished
- Packing: blister card



INDUSTRIAL



S2

STOCK NO.	SIZE	QTY./CARTON
20333	H3x50mm	320
20334	H4x50mm	320
20335	H5x50mm	320
20336	H6x50mm	320

32PCS PRECISION TOOL SET

- Contains:
- 1pc precision screwdriver handle
- 1pc 115mm extension bar
- 30pcs 4x28mm CrV bits:
 - SL: 1.0, 1.5, 2.0, 2.5, 3.0, 3.5, 4.0mm
 - PH: PH000, PH00, PH0, PH1
 - PZ: PZ0, PZ1
 - HEX: 0.7, 0.9, 1.3, 1.5, 2.0, 2.5, 3.0, 4.0mm
 - TX: T4, T5, T6, T7, T8, T9, T10, T15, T20
- Packing: color label



STOCK NO.	QTY./CARTON
20047	60



2PCS SCREWDRIVER BIT SET

- S2 industrial steel , hardened and tempered
- Satin finished
- Packing: blister card



INDUSTRIAL



STOCK NO.	SIZE	QTY./CARTON
20338	S1x50mm	320
20339	S2x50mm	320
20340	S3x50mm	320

10PCS DOUBLE END SCREWDRIVER BIT SET

- S2 industrial steel , hardened and tempered
- Satin finished
- Packing: blister card



INDUSTRIAL



STOCK NO.	SIZE	QTY./CARTON
20360	PH2/PH2x65mm	100

10PCS DOUBLE END SCREWDRIVER BIT SET

- S2 industrial steel , hardened and tempered
- Satin finished
- Packing: blister card



INDUSTRIAL



STOCK NO.	SIZE	QTY./CARTON
20361	PH2/SL5.5x65mm	100

40PCS SCREWDRIVER BIT SET

- Material: CrV
- 2pcs joints: 3/8"+1/2"
- 19pcs 30mm bits: T20, T25, T30, T40, T45, T50, T55; H4, H5, H6, H7, H8, H10, H12; M5, M6, M8, M10, M12
- 19pcs 75mm bits: T20, T25, T30, T40, T45, T50, T55; H4, H5, H6, H7, H8, H10, H12; M5, M6, M8, M10, M12
- Packing: color sleeve with shrink



STOCK NO.	QTY./CARTON
20385	8

15PCS SCREWDRIVER BIT SET

- 14 pcs 6.35x25mm S2 satin finished bits
Size:SL5,SL6,SL7,PH1,PH2,PH3,PZ1,PZ2,PZ3,T10,T15,T20,T25,T30
- 1pc 1/4"x60mm screwdriver bit holder with strong magnet
- Packing: plastic box



STOCK NO.	SIZE	QTY./CARTON
20365		96

33PCS MAGNETIC BIT HOLDER SET

- Contains:
 - 1pc 1/4"x60mm magnetic bit holder
 - 32pcs Cr-V 1/4"x25mm bits:
 - 9pcs Torx with hole: T8, T10, T15, T20, T25, T27, T30, T35, T40
 - 6pcs Hex with hole: H2, H2.5, H3, H4, H5, H6
 - 6pcs Hex with hole SAE: H5/64, H3/32, H7/64, H1/8, H9/64, H5/32
 - 3pcs X type: 6, 8, 10
 - 4pcs Y type: 1, 2, 3, 4
 - 4pcs Slot with hole: 4, 6, 8, 10
- Packing: plastic case with double blister



STOCK NO.	SIZE	QTY./CARTON
20369		48

32PCS SCREWDRIVER BIT SET

- 1pc 1/4" x 65mm screwdriver bit holder with strong magnet
- 30pcs 1/4" x 25mm S2 bits:
 - SL: 3, 4, 5, 6
 - PH: PH1, PH2, PH2, PH3
 - PZ: PZ1, PZ2, PZ3
 - Hex: H3, H4, H5, H6
 - Torx: T10, T15, T20, T25, T27, T30, T40
 - Torx (With hole): T10, T15, T20, T25, T27, T30, T40
- 1pc 1/4"x25mm adaptor
- Packing: color label



STOCK NO.	SIZE	QTY./CARTON
20370	1/4"	48

11PCS BIT SET

- 10pcs 1/4"x100mm screwdriver bits
- Material: 6150 Cr-V
- Chrome plated surface
- SL4x0.8, SL6x1.0
- PH1, PH2
- PZ1, PZ2
- T20, T25
- H3, H4
- 1/4"x65mm Quick-Release holder with strong magnet
- Durable case with easy access bit storage
- Unique bit design, different colors show different bit models, easy to identify.
- Packing: double blister



STOCK NO.	SIZE	QTY./CARTON
20375	1/4"	20

28PCS BIT AND SOCKET SET

- 6pcs 1/4" Sq.Dr. sockets: 6, 7, 8, 9, 10, 13mm
- Material: Cr-V
- Chrome plated surface
- 20pcs 1/4"x25mm screwdriver bits
- Material: 6150 Cr-V
- Chrome plated surface
- SL4x0.8, SL6x1.0
- PH1, PH2, PH3
- PZ1, PZ2, PZ3
- T10, T15, T20, T25, T30
- T10H, T15H, T20H, T25H, T30H
- H4, H5
- 1/4"x65mm Quick-Release holder with strong magnet
- 1/4"x25mm socket adaptor
- Durable case with easy access bit storage
- Unique bit design, different colors show different bit models, easy to identify.
- Packing: double blister



STOCK NO.	SIZE	QTY./CARTON
20376	1/4"	20

32PCS BIT SET

- 30pcs 1/4"x25mm screwdriver bits
- Material: 6150 Cr-V
- Chrome plated surface
- SL3x0.6, SL4x0.8, SL5x1.0, SL6x1.0
- PH1, PH2, PH3
- PZ1, PZ2, PZ3
- T10, T15, T20, T25, T27, T30, T40
- T10H, T15H, T20H, T25H, T27H, T30H, T40H
- H3, H4, H5, H6
- S1, S2
- 1/4"x65mm Quick-Release holder with strong magnet
- 1/4"x25mm socket adaptor
- Durable case with easy access bit storage
- Unique bit design, different colors show different bit models, easy to identify.
- Packing: double blister



STOCK NO.	SIZE	QTY./CARTON
20377	1/4"	20

14PCS NUT SOCKET SET

- Heat treatment, satin finished surface
- SAE: 3/16", 1/4", 9/32", 5/16", 11/32", 3/8", 7/16"
- Metric: 5, 5.5, 6, 7, 8, 10, 12mm
- 1/4" hex bits
- Length: 38mm
- Packing: blister card

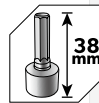

STOCK NO.	QTY./CARTON
77817	48

3PCS NUT SOCKET SET

- Without magnetic
- 1/4" hex bits
- Length: 38mm
- Packing: blister card



STOCK NO.	SIZE	QTY./CARTON
77812	3/8"	100

3PCS MAGNETIC NUT SOCKET SET

- 40Cr steel
- With strong magnetic
- 1/4" quick release hex bits
- Length: 48mm
- Packing: blister card



STOCK NO.	SIZE	QTY./CARTON
77823	8mm	100
77825	10mm	100
77830	1/4"	100
77831	5/16"	100
77832	3/8"	100
77838	1/4"+5/16"+3/8"	100

3PCS MAGNETIC NUT SOCKET SET

- 40Cr steel
- With strong magnetic
- 1/4" quick release hex bits
- Length: 65mm
- Packing: blister card



STOCK NO.	SIZE	QTY./CARTON
77841	6mm	100
77842	7mm	100
77843	8mm	100
77845	10mm	100
77846	11mm	100
77847	12mm	100
77848	13mm	100
77849	14mm	60
77858	1/4"+5/16"+3/8"	100

2PCS SCREWDRIVER BIT HOLDER SET

- Material: steel + CrV
- 1/4" quick release hex bits
- Packing: blister card



STOCK NO.	SIZE	QTY./CARTON
77861	60mm	100

SCREWDRIVER BIT HOLDER WITH QUICK RELEASE

- Material: CrV+Stainless steel+Aluminium
- With strong magnetic
- Packing: blister card



STOCK NO.	SIZE	QTY./CARTON
77863	60mm	100

3PCS SOCKET ADAPTOR

- DIN3123
- Material: 40Cr
- Sand blasting finishing
- Packing: blister card

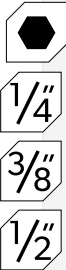

STOCK NO.	SIZE	QTY./CARTON
77864	1/4"x65mm	100
	3/8"x65mm	
	1/2"x70mm	

3PCS SDS-PLUS ADAPTOR

- Material: 40Cr
- Sand blasting finishing
- Packing: blister card



STOCK NO.	SIZE	LENGTH	QTY./CARTON
77865	Ø10mm x 1/4"	65mm	100
	Ø10mm x 3/8"	65mm	
	Ø10mm x 1/2"	72mm	

10PCS HEX KEY SET ON RING

- Packing: blister card



STOCK NO.	SIZE	QTY./CARTON
20051	1.5, 2, 2.5, 3, 4, 5, 5.5, 6, 8, 10mm	80

9PCS LONG ARM HEX KEY SET

- CrV
- Heat treated, chrome plated
- Packing: blister card



STOCK NO.	SIZE	QTY./CARTON
20048	1.5, 2, 2.5, 3, 4, 5, 6, 8, 10mm	36

9PCS EXTRA-LONG ARM HEX KEY SET

- CrV
- Heat treated, chrome plated
- Packing: blister card

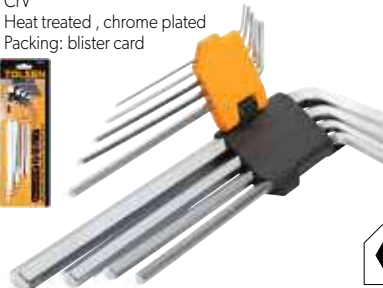

STOCK NO.	SIZE	QTY./CARTON
20049	1.5, 2, 2.5, 3, 4, 5, 6, 8, 10mm	36

9PCS BALL POINT LONG ARM HEX KEY SET

- CrV
- Heat treated, chrome plated
- Packing: blister card



STOCK NO.	SIZE	QTY./CARTON
20053	1.5, 2, 2.5, 3, 4, 5, 6, 8, 10mm	36

9PCS BALL POINT EXTRA-LONG ARM HEX KEY SET

- CrV
- Heat treated, chrome plated
- Packing: blister card



STOCK NO.	SIZE	QTY./CARTON
20054	1.5, 2, 2.5, 3, 4, 5, 6, 8, 10mm	36

9PCS TORX LONG ARM HEX KEY SET

- CrV
- Heat treated, chrome plated
- Packing: blister card



STOCK NO.	SIZE	QTY./CARTON
20056	T10, T15, T20, T25, T27, T30, T40, T45, T50	36

9PCS TORX EXTRA-LONG ARM HEX KEY SET

- CrV
- Heat treated, chrome plated
- Packing: blister card



STOCK NO.	SIZE	QTY./CARTON
20057	T10, T15, T20, T25, T27, T30, T40, T45, T50	36

8PCS FOLDING BALL POINT HEX KEY SET

- CrV
- Heat treated, chrome plated
- Packing: plastic hanger with color label



STOCK NO.	SIZE	QTY./CARTON
20068	1.5, 2, 2.5, 3, 4, 5, 6, 8mm	60

9PCS FOLDING HEX KEY SET (INCH)

- CrV
- Heat treated, chrome plated
- Packing: plastic hanger with color label



STOCK NO.	SIZE	QTY./CARTON
20098	5/64", 3/32", 7/64", 1/8", 9/64", 5/32", 3/16", 7/32", 1/4"	60

8PCS FOLDING TORX HEX KEY SET

- CrV
- Heat treated, chrome plated
- Packing: plastic hanger with color label



STOCK NO.	SIZE	QTY./CARTON
20069	T9, T10, T15, T20, T25, T27, T30, T40	60

13PCS BALL POINT LONG ARM HEX KEY SET (INCH)

- CrV
- Heat treated
- Black finished
- Packing: blister card



STOCK NO.	SIZE	QTY./CARTON
20090	0.05"-1/16"-5/64"-3/32"-7/64"-1/8"-9/64"-5/32"-3/16"-7/32"-1/4"-5/16"-3/8"	36

36PCS INCH & METRIC HEX KEY SET

- CrV
- Long: 1/16"-5/64"-3/32"-1/8"-9/64"-5/32"-3/16"-1/4"-5/16"
- Short: 0.05"-1/16"-5/64"-3/32"-7/64"-1/8"-5/32"-3/16"-7/32"
- Long: 1.5-2-2.5-3-4-4.5-5-6-8mm
- Short: 1.27-1.5-2-2.5-3-3.5-4-5-5.5mm
- Heat treated
- Black finished
- Packing: blister card

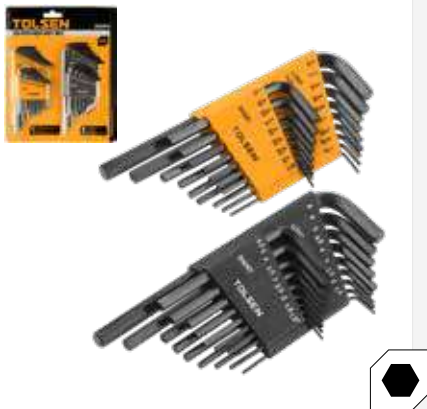

STOCK NO.	QTY./CARTON
20094	20

8PCS TORX T-HANDLE SCREWDRIVER SET

- CrV
- Bi-colour comfortable grip
- Packing: double blister



STOCK NO.	SIZE	QTY./CARTON
20061	T-10x75mm, T-15x75mm, T-20x100mm, T-25x100mm, T-30x150mm, T-40x150mm, T-45x200mm, T-50x200mm	20

8PCS BALL POINT T-HANDLE SCREWDRIVER SET

- CrV
- Bi-colour comfortable grip
- Packing: double blister



STOCK NO.	SIZE	QTY./CARTON
20062	H2.0x100mm, H2.5x100mm, H3.0x100mm, H4.0x150mm, H5.0x150mm, H6.0x200mm, H8.0x200mm, H10.0x200mm	20

HAND RIVETER

- Hardened steel body
- Supplied nozzle wrench
- Suitable for aluminium rivets
- Packing: blister card

	2.4mm (3/32")	3.2mm (1/8")	4mm (5/32")	4.8mm (3/16")
Aluminium	•	•	•	•



STOCK NO.	SIZE	QTY./CARTON
43001	10"	24

HAND RIVETER

- Powder coated aluminum alloy body
- Labor-saving ergonomic handle with comfortable PVC grips
- 5 replaceable nosepieces
- Support Rivets:
 - Stainless Steel Rivet: 2.4mm(3/32"), 3.2mm(1/8"), 4.0mm(5/32"), 4.8mm(3/16")
 - Iron Rivet: 2.4mm(3/32"), 3.2mm(1/8"), 4.0mm(5/32"), 4.8mm(3/16"), 6.4mm(1/4")
 - Aluminum Rivet: 2.4mm(3/32"), 3.2mm(1/8"), 4.0mm(5/32"), 4.8mm(3/16"), 6.4mm(1/4")
- A built-in collection bottle collects the spent cores for safety issues and easy disposal
- Packing: color box



STOCK NO.	SIZE	QTY./CARTON
43096	13"	12

HAND RIVETER

- Powder coated Aluminium alloy body
- Innovative patented structure
- Over 40% labor saving design
- Ergonomic handles with comfortable TPR grips
- Three Jaws, alloy steel, HRC 58-62
- Maximum working stroke: 7mm, adjustable
- Suitable for Aluminium, Steel and **Stainless steel rivets**
- Packing: double blister

	2.4mm (3/32")	3.2mm (1/8")	4mm (5/32")	4.8mm (3/16")
Aluminium	•	•	•	•
Steel	•	•	•	•
Stainless steel	•	•	•	•



STOCK NO.	SIZE	QTY./CARTON
43099	190mm, 8"	24

HAND RIVETER

- Aluminium body
- Supplied nozzle wrench
- Suitable for aluminium rivets
- Packing: blister card

	2.4mm (3/32")	3.2mm (1/8")	4mm (5/32")	4.8mm (3/16")
Aluminium	•	•	•	•



STOCK NO.	SIZE	QTY./CARTON
43003	10.5"	24

SUPPLIED WITH NOZZLE WRENCH

COLLECTION BOTTLE

HEAVY DUTY FOLDING HAND RIVETER

- Powder coated Aluminium alloy body
- Over 20% labor saving design
- Ergonomic handles with comfortable TPR grips
- Three jaws, alloy steel, HRC 58-62
- Maximum working stroke: 9mm, adjustable
- Suitable for Aluminium, Steel and **Stainless steel rivets**
- Packing: color box

INDUSTRIAL

	2.4mm (3/32")	3.2mm (1/8")	4mm (5/32")	4.8mm (3/16")	6.4mm (1/4")
Aluminium	•	•	•	•	•
Steel	•	•	•	•	•
Stainless steel	•	•	•	•	•



STOCK NO.	SIZE	QTY./CARTON
43100	32"	8

OPEN END BLIND RIVET

- Aluminium
- 50pcs packed in a bag with paper hanger

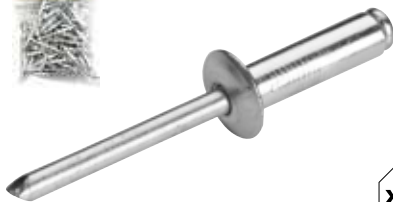

x50

STOCK NO.	SIZE	QTY./CARTON
43005	2.4x6.4mm	300
43006	2.4x8mm	300
43007	3.2x6.4mm	250
43008	3.2x10mm	250
43009	4x10mm	200
43010	4x12.7mm	200
43011	4.8x12.7mm	150
43012	4.8x16mm	150

STAPLES

- 1000pcs packed in a color box

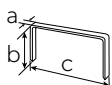
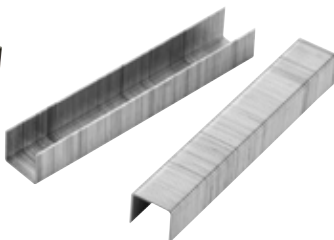

STOCK NO.	SIZE			QTY./CARTON
	a	b	c	
43023	0.7mm	6mm	11.3mm	200
43024	0.7mm	8mm	11.3mm	200
43025	0.7mm	10mm	11.3mm	200
43028	1.2mm	8mm	11.3mm	100
43029	1.2mm	10mm	11.3mm	100
43030	1.2mm	12mm	11.3mm	100

HEAVY DUTY 3 WAY STAPLE GUN

- GS approval
- Surface: powder coated
- With 200pcs each of crown, U-shape, brad nails.
- Compatible staples: Rapid 140, Arrow T50, Arrow T18, Rapid 28, Esco 300
- Packing: double blister

INDUSTRIAL

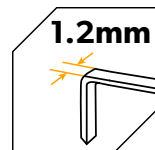

- NARROW CROWN**
ARROW T50
RAPID 140
4-14mm
5/32"-9/16"
- U-SHAPE STAPLE**
ARROW T18
RAPID 28
10-12mm
3/8"-1/2"
- BRAD NAIL**
ARROW T50 BN
ESCO 300
10-14mm
3/8"-9/16"

STOCK NO.	SIZE	QTY./CARTON
43021	4-14mm (5/32"-9/16")	24

STAPLE GUN

- GS approval
- Surface: powder coated
- Compatible staples: Rapid 530, Arrow Jt21
- Packing: blister card

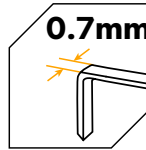

STOCK NO.	SIZE	QTY./CARTON
43022	4-8mm (5/32"-5/16")	40

HEAVY DUTY STAPLE GUN

- GS approval
- For fine wire staples 0.7mm
- Staple leg length: 4-14mm (5/32"-9/16")
- Quick jam release button
- Impact power adjustment
- Surface: Paint finish
- With 500pcs 0.7x8mm crown staples
- Packing: double blister

INDUSTRIAL



STOCK NO.	SIZE	QTY./CARTON
43020	4-14mm (5/32"-9/16")	24

PREMIUM

STRIKING TOOLS



MACHINIST HAMMER

- Drop-forged special tool steel hammerhead
- Black painted, heat treatment
- Wooden handle
- Packing: color label



STOCK NO.	HEAD WEIGHT	QTY./CARTON
25121	200g	60
25122	300g	48
25123	500g	24
25124	1000g	16
25125	1500g	8
25126	2000g	8

MACHINIST HAMMER

- Drop-forged special tool steel hammerhead
- Black painted, heat treatment
- Fiberglass handle
- Packing: color label



STOCK NO.	HEAD WEIGHT	QTY./CARTON
25001	200g	60
25002	300g	36
25003	500g	24
25005	800g	16
25006	1000g	16
25007	1500g	8
25008	2000g	8

ONE PIECE FORGED CLAW HAMMER

- Solid forged one piece, hardened and tempered
- Fully polished and lacquered
- Solid forged shaft with shock-absorbing fiberglass grip to reduce vibrations when striking
- Packing: hang tag with color box



STOCK NO.	HEAD WEIGHT	QTY./CARTON
25171	16OZ	16

ONE PIECE FORGED ROOFING HAMMER

- Solid forged one piece, hardened and tempered;
- Fully polished and lacquered
- Solid forged shaft with shock-absorbing fiberglass grip to reduce vibrations when striking;
- With milled striking face
- With magnetic nail holder
- Packing: hang tag with color box



STOCK NO.	HEAD WEIGHT	QTY./CARTON
25172	600g	16

PREMIUM

STONING HAMMER

- Drop-forged special tool steel hammerhead
- Black painted, heat treatment
- Wooden handle
- Packing: color label



STOCK NO.	HEAD WEIGHT	QTY./CARTON
25130	1000g	16
25132	1500g	12
25133	2000g	8

STONING HAMMER

- Drop-forged special tool steel hammerhead
- Black painted, heat treatment
- Fibreglass handle
- Packing: color label



STOCK NO.	HEAD WEIGHT	QTY./CARTON
25010	1000g	16
25012	1500g	12
25013	2000g	8

SLEDGE HAMMER

- Drop-forged special tool steel hammerhead
- Black painted, heat treatment
- Fibreglass handle
- Packing: color label



STOCK NO.	HEAD WEIGHT	QTY./CARTON
25043	2LBS	16
25900	3LBS	12
25044	4LBS	8

FIBREGLASS SHAFT CLUB HAMMER

- Drop forged special tool steel hammerhead,
- black painted, heat treatment,
- Fibreglass handle 4Lbs / 1.8kg
- Packing: color label



STOCK NO.	HEAD WEIGHT	QTY./CARTON
25049	4LBS 1800g	8

STONING HAMMER

- Drop-forged special tool steel hammerhead
- Black painted, heat treatment
- Wooden handle
- Packing: color label



STOCK NO.	HEAD WEIGHT	LENGTH	QTY./CARTON
25136	5kgs	900mm	4

SLEDGE HAMMER

- Drop-forged special tool steel hammerhead
- Black painted, heat treatment
- Packing: color label



STOCK NO.	HEAD WEIGHT	LENGTH	QTY./CARTON
25151	10LBS	900mm	4

STONING HAMMER

- Drop-forged special tool steel hammerhead
- black painted, heat treatment
- Fibreglass handle
- Packing: color label



STOCK NO.	HEAD WEIGHT	LENGTH	QTY./CARTON
25016	5kgs	880mm	4

SLEDGE HAMMER

- Drop-forged special tool steel hammerhead
- Black painted, heat treatment
- Fibreglass handle
- Packing: color label



STOCK NO.	HEAD WEIGHT	LENGTH	QTY./CARTON
25045	6LBS	680mm	6
25046	8LBS	680mm	4
25047	10LBS	880mm	4

BALL PEIN HAMMER

- Drop-forged special tool steel hammerhead
- Heat treatment, ground polished
- Wooden handle
- Packing: color label



STOCK NO.	HEAD WEIGHT	QTY./CARTON
25142	16OZ	24
25145	32OZ	16

CLAW HAMMER

- Drop-forged special tool steel hammerhead
- Heat treatment, ground polished
- Wooden handle
- Packing: color label



STOCK NO.	HEAD WEIGHT	FACE DIA.	QTY./ CARTON
25148	8OZ	23mm	36
25150	16OZ	29mm	24
25032	20OZ	31mm	24

CLAW HAMMER, BRITISH TYPE

- Drop-forged special tool steel hammerhead,
- Heat treatment, ground polished
- Wooden handle
- Packing: color label



STOCK NO.	FACE DIA.	QTY./CARTON
25164	25mm	36
25165	27mm	24

BALL PEIN HAMMER

- Drop-forged special tool steel hammerhead
- Heat treatment, ground polished
- Fiberglass handle
- Packing: color label



STOCK NO.	HEAD WEIGHT	QTY./CARTON
25022	16OZ	24
25025	32OZ	16

CLAW HAMMER

- Hammerhead same like regular 8OZ Claw hammer
- Drop forged special tool steel hammerhead
- Heat treatment, ground polished
- Fiberglass handle
- Packing: hang tag



STOCK NO.	HEAD WEIGHT	QTY./CARTON
25027	8OZ	36

CLAW HAMMER

- Drop-forged special tool steel hammerhead
- Heat treatment, ground polished
- Fiberglass handle
- Packing: color label



STOCK NO.	HEAD WEIGHT	FACE DIA.	QTY./ CARTON
25028	8OZ	23mm	36
25030	16OZ	29mm	24
25031	20OZ	31mm	24

CLAW HAMMER

- Drop forged special tool steel hammerhead
- Heat treatment, ground polished
- With milled striking face
- With magnetic nail holder
- Fiberglass handle
- Packing: color label

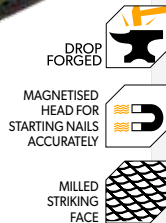

STOCK NO.	HEAD WEIGHT	QTY./CARTON
25185	16OZ	24

CLAW HAMMER, BRITISH TYPE

- Drop-forged special tool steel hammerhead
- Heat treatment, ground polished
- Fiberglass handle
- Packing: color label



STOCK NO.	FACE DIA.	QTY./CARTON
25158	25mm	36
25160	27mm	24

RIP HAMMER

- Drop forged special tool steel hammer head,
- Heat treatment, ground polished
- Fiberglass handle 16oz
- Packing: color label



STOCK NO.	HEAD WEIGHT	QTY./CARTON
25156	16OZ	24

CLAW HAMMER, FRENCH TYPE

- Drop forged special tool steel hammerhead,
- Heat treatment, ground polished
- With milled striking face
- With magnetic nail holder
- Fiberglass handle
- Packing: color label



STOCK NO.	HEAD WEIGHT	QTY./CARTON
25190	700g	24

CHIPPING HAMMER

- Drop forged special tool steel hammerhead,
- Heat treatment, ground polished
- Fiberglass handle
- Packing: color label



STOCK NO.	HEAD WEIGHT	QTY./CARTON
25188	500g	24

ROOFING HAMMER

- Drop-forged roofing hammer
- Heat treatment
- With milled striking face
- With magnetic nail holder
- Packing: color label

GRIPPro series



- DROP FORGED**
- MAGNETISED HEAD FOR STARTING NAILS ACCURATELY**
- MILLED STRIKING FACE**

STOCK NO.	HEAD WEIGHT	QTY./CARTON
25167	600g	16

DEAD BLOW Mallet

- Non-marring PVC plastic faces
- Non-rebounding
- Non-spark
- Packing: color label



STOCK NO.	HEAD WEIGHT	QTY./CARTON
25040	900g/2LBS	16

RUBBER Mallet

- Rubber hammerhead
- Fiberglass handle
- Packing: color label

GRIPPro series



STOCK NO.	HEAD WEIGHT	QTY./CARTON
25033	225g / 8OZ	36
25035	450g / 16OZ	24
25037	675g / 24OZ	16
25038	900g / 32OZ	16

RUBBER Mallet

- Natural rubber hammerhead
- Fiberglass handle
- Packing: color label

GRIPPro series



STOCK NO.	HEAD WEIGHT	QTY./CARTON
25173	225g / 8OZ	36
25175	450g / 16OZ	24
25177	675g / 24OZ	16

INDUSTRIAL

TWO WAY Mallet

- PVC head
- Fiberglass handle
- Packing: color label

GRIPPro series



STOCK NO.	FACE DIA.	QTY./CARTON
25042	35mm	36

HATCHET

- Drop-forged special tool steel
- powder coated, polished
- Wooden handle
- Packing: color label



STOCK NO.	HEAD WEIGHT	LENGTH	QTY./CARTON
25253	600g	380mm	24
25254	800g	380mm	24
25255	1000g	450mm	12
25256	1250g	750mm	12

HATCHET

- Drop-forged special tool steel
- powder coated, heat treatment
- Fiberglass handle
- Packing: color label



STOCK NO.	HEAD WEIGHT	LENGTH	QTY./CARTON
25053	600g	380mm	24
25054	800g	380mm	18
25051	1250g	800mm	12
25052	1500g	800mm	8

INDUSTRIAL

WOOD CHISEL

- CrV
- Two-component plastic handle
- Packing: double blister

GRIPPro series



STOCK NO.	SIZE	QTY./CARTON
25056	6mm (1/4")	60
25058	8mm (5/16")	60
25060	10mm (3/8")	60
25061	12mm (15/32")	60
25062	13mm (1/2")	60
25063	14mm (35/64")	60
25065	16mm (5/8")	60
25066	18mm (45/64")	60
25067	19mm (3/4")	60
25068	20mm (25/32")	60
25069	22mm (7/8")	60
25070	24mm (15/16")	60
25071	25mm (1")	60
25072	26mm (1-1/64")	60
25073	32mm (1-1/4")	40
25075	38mm (1-1/2")	40
25079	51mm (2")	40

4PCS WOOD CHISEL SET

- CrV
- Two-component plastic handle
- Packing: double blister

GRIPPro series



STOCK NO.	SIZE	QTY./CARTON
25384	6mm(1/4")-13mm(1/2")-19mm(3/4")-25mm(1")	12

3PCS WOOD CHISEL

- CrV
- PP plastic handle
- Packing: double blister



STOCK NO.	SIZE	QTY./CARTON
25380	13mm(1/2")-19mm(3/4")-25mm(1")	24

INDUSTRIAL

INDUSTRIAL

COLD CHISEL

- Special tool steel
- Powder coated
- Packing: color sticker

GRIPPro
series



BIG PLATE
PROVIDES
BETTER PROTECTION



STOCK NO.	SIZE	QTY./CARTON
25083	4x16x250mm	36
25084	4x18x300mm	24

COLD CHISEL

- Special tool steel
- Powder coated
- Packing: color sticker

GRIPPro
series



BIG PLATE
PROVIDES
BETTER PROTECTION



STOCK NO.	SIZE	QTY./CARTON
25087	22x16x250mm	36
25088	24x18x300mm	24

COLD CHISEL

- Special tool steel
- Powder coated
- Packing: color sticker

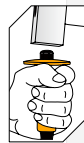

STOCK NO.	SIZE	QTY./CARTON
25082	4x16x250mm	36
25085	4x18x300mm	24

COLD CHISEL

- Special tool steel
- Powder coated
- Packing: color sticker

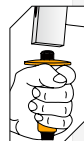

STOCK NO.	SIZE	QTY./CARTON
25086	22x16x250mm	36

6PCS PUNCH SET

- CrV
- HRC56-62
- Powder coated
- Packing: plastic box with color label



STOCK NO.	SIZE	QTY./CARTON
25090	1.5x6x150, 3x8x150, 4x8x150, 5x8x150, 6x10x150, 8x10x150mm	20

5PCS PUNCH SET

- CrV
- HRC56-62
- Powder coated
- Packing: plastic box with color label



STOCK NO.	SIZE	QTY./CARTON
25091	1pc cold chisel: 13x10x150mm 1pc cape chisel: 5x10x150mm 1pc pin chisel: 8x10x150mm 1pc taper chisel: 2x10x150mm 1pc centre chisel: 3x10x150mm	20

9PCS LEATHER PUNCHER

- Special tool steel, hardened
- Packing: blister card



STOCK NO.	SIZE	QTY./CARTON
25093	2.5, 3, 4, 5, 6, 7, 8, 9, 10mm	40

9PCS FIGURE PUNCH

- Special tool steel, hardened
- Surface sandblasting
- Packing: color box



STOCK NO.	SIZE	QTY./CARTON
25094	3mm	96
25097	6mm	48

27PCS LETTER PUNCH

- Special tool steel, hardened
- Surface sandblasting
- Packing: color box



STOCK NO.	SIZE	QTY./CARTON
25101	3mm	36
25104	6mm	18

CROWBAR

- Forged special tool steel with heat treatment
- HRC52-56
- Paint coating
- Packing: color label



STOCK NO.	SIZE	QTY./CARTON
25109	600x16mm	12
25111	750x18mm	12

HEAVY DUTY CROWBAR

- Forged carbon steel with heat treatment
- Powder coated
- Packed with color label

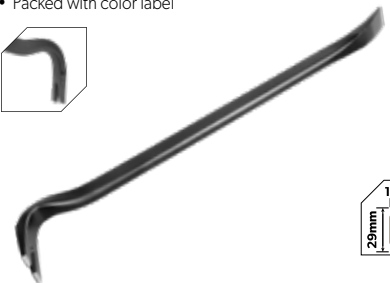

STOCK NO.	SIZE	QTY./CARTON
25118	24" / 610mm	6
25119	36" / 910mm	6
25120	48" / 1200mm	4

FLAT PRY BAR

- Special tool steel
- Powder coat finish
- Rugged beveled edges
- Nail slots at both ends
- Packing: color label

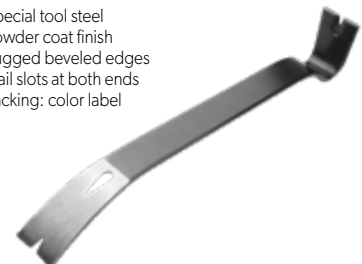

STOCK NO.	SIZE	QTY./CARTON
25113	7" / 180mm	100
25115	375x35x6mm, 15"x1-3/8"x1/4"	20



CUTTING TOOLS

SNAP-OFF BLADE KNIFE

- ABS case
- With flat push button
- Packing: OPP bag



SK5

STOCK NO.	BLADE SIZE	QTY./CARTON
30081	18x100mm	240

SNAP-OFF BLADE KNIFE

- ABS case
- With flat push button
- Packing: label+display box



STOCK NO.	BLADE SIZE	QTY./CARTON
30001	18x100mm	96

SNAP-OFF BLADE KNIFE

- Aluminium case
- With flat push button
- Packing: blister card



SK5

STOCK NO.	BLADE SIZE	QTY./CARTON
30002	18x100mm	144

SNAP-OFF BLADE KNIFE

- ABS case+ TPR
- With 3pcs blades
- With flat push button
- Packing: blister card



STOCK NO.	BLADE SIZE	QTY./CARTON
30003	18x100mm	96

SNAP-OFF BLADE KNIFE

- ABS case + TPR
- Self-lock
- With 3pcs SK4 blades
- Packing: blister card



INDUSTRIAL

SK4



STOCK NO.	BLADE SIZE	QTY./CARTON
30015	18x100mm	96

SNAP-OFF BLADE KNIFE

- ABS case+ TPR
- With 3pcs SK5 blades
- With flat push button
- Safe loading
- Packing: blister card



INDUSTRIAL

SK5



STOCK NO.	BLADE SIZE	QTY./CARTON
30016	25x125mm	48

SNAP-OFF BLADE KNIFE

- ABS case + TPR
- With 1pc blade
- With round knob
- Manual-locking blade system
- Packing: blister card



SK5

STOCK NO.	BLADE SIZE	QTY./CARTON
30018	18x100mm	144

SNAP-OFF BLADE KNIFE

- ABS case
- With flat push button
- Packing: OPP bag



NEW



STOCK NO.	BLADE SIZE	QTY./CARTON
30080	9x80mm	800

SNAP-OFF BLADE KNIFE

- Stainless case
- With flat push button
- Packing: display box



13 CUTTING POINTS

STOCK NO.	BLADE SIZE	QTY./CARTON
30005	9x80mm	960

SCRAPER

- ABS case
- With 3pcs blades
- Packing: skin card



STOCK NO.	BLADE SIZE	QTY./CARTON
30006	100x18.5x0.4mm	120

SCRAPER

- ABS case
- SK5 blade
- Blade size: 61x19x0.6mm
- Packing: paper hanger



SK5

STOCK NO.	BLADE SIZE	QTY./CARTON
30014	61x19mm	200

HEAVY DUTY SCRAPER

- Aluminum cutter head with silver painting
- SK5 blade: 100x18x0.5mm
- The blade can be replaced with TOLSEN 30011
- Steel tube with soft grip handle
- Ideal for removing dry paint from glass windows, scraping off wallpaper and other similar applications
- Packing: double blister

INDUSTRIAL



SK5

STOCK NO.	BLADE SIZE	QTY./CARTON
30101	300mm / 12"	48
30102	600mm / 24"	36

UTILITY KNIFE

- Aluminium handle
- With 5pcs SK5 blades
- Packing: double blister



SK5



STOCK NO.	BLADE SIZE	QTY./CARTON
30007	61x19mm	72

UTILITY KNIFE

- Aluminium alloy body
- Material of blade: SK5
- Packing: double blister



SK5

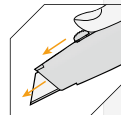

STOCK NO.	BLADE SIZE	QTY./CARTON
30008	61x19mm	96

DOUBLE FUNCTION UTILITY KNIFE

- Zinc alloy body with TPR
- Material of blade: SK2
- Auto lock function
- Auto retractable function
- Quick change blade
- Including 2pcs additional SK2 blades
- Packing: blister card

INDUSTRIAL



SK2



STOCK NO.	BLADE SIZE	QTY./CARTON
30019	61x19mm	60

UTILITY KNIFE

- ABS transparent case
- Overall size: 154x38.5x25.5mm
- With 1pc SK5 blade: 61x19mm
- Standard blades store securely in handle
- Packing: color bag

NEW



SK5

STOCK NO.	BLADE SIZE	QTY./CARTON
30086	61x19mm	144

UTILITY KNIFE FIXED BLADE

- Lightweight aluminium construction body
- Standard blades store securely in handle
- Material of blade: SK5
- Packing: PP card



SK5

STOCK NO.	BLADE SIZE	QTY./CARTON
30108	61x19mm	144

10PCS BLADE SET

- 10pcs blade
- Thickness: 0.6mm
- Material: SK5
- Fit with 30008, 30007, 30019, 30108
- Packing: plastic box with color sticker



SK5

STOCK NO.	BLADE SIZE	QTY./CARTON
30010	61x31x19mm	400

5PCS BLADE SET

- 5pcs blade
- Thickness: 0.6mm
- Material: SK5
- Packing: skin card



SK5

STOCK NO.	BLADE SIZE	QTY./CARTON
30013	50x38x19mm	240

10PCS BLADE SET

- Thickness: 0.6mm
- Material: SK5
- With heat treatment
- precision triangle position hole
- Two professional cutting edges
- Fit with 30008, 30007, 30019, 30108
- 10pcs packed in a plastic box



SK5

STOCK NO.	BLADE SIZE	QTY./CARTON
30113	50x31x19mm	240

10PCS BLADE SET

- 10pcs blade
- Thickness: 0.7mm
- Material: SK5
- Packing: blister card

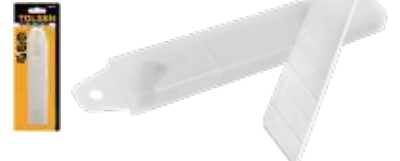

STOCK NO.	BLADE SIZE	QTY./CARTON
30017	25x125mm	80

10PCS BLADE SET

- 10pcs blade
- Thickness: 0.5mm
- Material: high quality tool steel
- Packing: plastic box with color sticker



STOCK NO.	BLADE SIZE	QTY./CARTON
30011	18x100mm	240

10PCS BLADE SET

- 10pcs blade
- Thickness: 0.4mm
- Material: high quality tool steel
- Packing: plastic box with color sticker



STOCK NO.	BLADE SIZE	QTY./CARTON
30012	9x80mm	480

10PCS BLADE SET

- Size: 100x18x0.4mm
- Material: high quality tool steel
- Suitable for TOLSEN 30006
- Packing: plastic box with color label



STOCK NO.	BLADE SIZE	QTY./CARTON
30116	100x18x0.4mm	240

AVIATION SNIPS (LEFT)

- CrMo
- Two-component plastic handle
- Packing: blister card



GRIPPro
series



LEFT CUT

STOCK NO.	SIZE	QTY./CARTON
30021	250mm,10"	30

INDUSTRIAL

AVIATION SNIPS (STRAIGHT)

- CrMo
- Two-component plastic handle
- Packing: blister card



GRIPPro
series



STRAIGHT CUT

STOCK NO.	SIZE	QTY./CARTON
30022	250mm,10"	30

INDUSTRIAL

AVIATION SNIPS (RIGHT)

- CrMo
- Two-component plastic handle
- Packing: blister card



GRIPPro
series



RIGHT CUT

STOCK NO.	SIZE	QTY./CARTON
30023	250mm,10"	30

INDUSTRIAL

TINMAN'S SNIPS

- Drop forged high quality tool steel
- Dipped handle
- Packing: blister card



STOCK NO.	SIZE	QTY./CARTON
30030	250mm,10"	30

TIN SNIPS

- Drop forged special tool steel
- Dipped handle
- Packing: PVC bag with color sleeve



STOCK NO.	SIZE	QTY./CARTON
30036	10"	24
30037	12"	20

MULTI-PURPOSE SCISSORS

- Stainless steel blade
- Packing: blister card



STOCK NO.	SIZE	QTY./CARTON
30042	180mm,7"	72

HOUSEHOLD SCISSORS

- Stainless steel blade
- Packing: blister card



COMFORT GRIPS

STOCK NO.	SIZE	QTY./CARTON
30044	200mm,8"	144

KITCHEN SCISSORS

- Stainless steel blade
- Packing: blister card



NUT CRACKER

STOCK NO.	SIZE	QTY./CARTON
30045	200mm,8"	144

MULTI-PURPOSE SCISSORS

- Multi-purpose: scissors, small knife, nut cracker, cable cutter/wire cutter, fish scale remover, bottle opener, jar opener, peeler, slot screwdriver
- Stainless steel blade
- Ergonomic large non-slip handle
- Packing: double blister

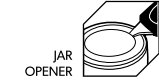

STOCK NO.	SIZE	QTY./CARTON
30049	220mm,8-3/4"	72

MULTIPURPOSE PLIERS

- 2Cr13 steel
- With fine polished surface
- Packing: double blister + display box



14 IN 1
MULTITOLS

STOCK NO.	SIZE	QTY./CARTON
30046	102x46x23mm	24

15-IN-1 MULTI-FUNCTION POCKET FOLDING KNIFE

- With Strong Aluminium Handle
- Material of Accessories: stainless steel
- Large knife
- Can opener
- Phillips screwdriver
- Leather punch
- Bottle Opener
- Scissors
- Needle
- Slotted Screwdriver
- Fish scaler
- Hook remover
- Saw
- Corkscrew
- Nail cleaner
- Nail file
- Key ring
- Packing: hang tag with display box



NEW



15
FUNCTIONS
STAINLESS
STEEL
BLADE

STOCK NO.	SIZE	QTY./CARTON
30048	97x30x17mm	48

MINI HACKSAW FRAME

- Including 1pc saw blade
- Packing: color bag



STOCK NO.	SIZE	QTY./CARTON
30050	150mm,6"	120

MINI HACKSAW FRAME

- Plastic coated handle
- Including 1pc saw blade
- Packing: color label



STOCK NO.	SIZE	QTY./CARTON
30051	150mm,6"	120

HACKSAW FRAME

- Square powder-coated steel tube bow frame
- With ABS handle
- Including 1pc saw blade
- Packing: color sticker



STOCK NO.	SIZE	QTY./CARTON
30052	300mm,12"	60

HACKSAW FRAME

- Round powder-coated steel tube bow frame
- With aluminium handle
- Including 1pc saw blade
- Packing: color sticker



STOCK NO.	SIZE	QTY./CARTON
30053	300mm,12"	36

HACKSAW FRAME

- Square powder-coated steel tube bow frame
- With aluminium & TPR handle
- Including 1pc saw blade
- Packing: color sleeve



STOCK NO.	SIZE	QTY./CARTON
30054	300mm,12"	36

HACKSAW FRAME

- Square powder-coated steel tube bow frame
- With aluminium handle
- Including 1pc saw blade
- Packing: paper hanger



STOCK NO.	SIZE	QTY./CARTON
30055	300mm,12"	36

ADJUSTABLE HACKSAW FRAME

- With steel handle
- Including 1pc saw blade
- Packing: color sleeve



STOCK NO.	SIZE	QTY./CARTON
30056	8"-10"-12"	36

UNIVERSAL GROUND SAW

- 7TPI 65Mn blade
- Two-component plastic handle
- Packing: blister card



STOCK NO.	BLADE LENGTH	QTY./CARTON
31013	150mm,6"	48

MINI HACKSAW BLADE

- Material: SK4
- Black finished surface
- 24 TPI
- Suitable for TOLSEN stock No. 30050 and 30051
- 10pcs packed in PP color bag



STOCK NO.	SIZE	QTY./CARTON
30060	150mm,6"	200

HACKSAW BLADE

- Special tool steel
- 24TPI
- 10pcs packed in color label with shrink



STOCK NO.	SIZE	QTY./CARTON
30061	300mm,12"	100

BI-METAL HACKSAW BLADE

- Material: M2+D6A
- 24TPI
- 2pcs packed in paper hanger



STOCK NO.	SIZE	QTY./CARTON
30064	12"x1/2"	120

BI-METAL HACKSAW BLADE

- Material: M2+D6A
- 100pcs packed in plastic box



STOCK NO.	SIZE	QTY./CARTON
30065	300x12mm, 12"x1/2" 24TPI	10sets
30066	300x12mm, 12"x1/2" 18TPI	10sets

MITRE BOX WITH BACK SAW SET

- 1pc saw: 300mm / 12", 13TPI, 65Mn blade
Thickness: 0.8mm
- 1pc mitre box: 300x140x70mm, ABS material
- Packing: color sleeve



STOCK NO.	QTY./CARTON
31017	12

MASONRY SAW

- 65Mn blade, heat treated
- With carbide tipped teeth
- Two-component plastic handle
- Packing: color sleeve



STOCK NO.	SIZE	QTY./CARTON
31065	22" / 550mm, 13Teeth	18
31068	28" / 710mm, 17Teeth	12

INDUSTRIAL

INDUSTRIAL

INDUSTRIAL

INDUSTRIAL

INDUSTRIAL

TOLSEN GARDENEST

THE RIGHT GARDEN TOOLS



PETROL LAWN MOWER

- Zongshen brand engine
- Displacement: 149cc
- Euro 5 emission standard approval
- CE approval
- Rated power: 2200W(3HP)
- Rated speed: 2850rpm
- Drive type: Hand push
- Powerful 4-stroke air-cooled gasoline engine
- Cutting height: 25-70mm (8 positions)
- Cutting width: 510mm / 20"
- Deck material: steel
- Grass box volume: 65L
- Fuel tank capacity: 0.85L
- Oil volume: 0.4L
- Front wheel size: 178mm
- Rear wheel size: 250mm
- Packed by carton box



**3-IN-1 FUNCTION
MULCHING
BAGGING
SIDE DISCHARGE**



STOCK NO.	SIZE	QTY./CARTON
79624	149cc (2200W)	1

ELECTRIC LAWN MOWER **1400W**

- CE approval
- Input power: 1400W
- Rated Voltage: 220-240V
- Frequency: 50/60HZ
- Drive type: Hand push
- No-load speed: 3400rpm
- Carbon brush motor
- Cutting width: 330mm / 13"
- Cutting height: 30-75mm (5 positions)
- Grass bag size: 35L
- Front wheel size: 140mm
- Rear wheel size: 200mm
- Packed by carton box

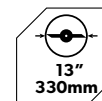

STOCK NO.	SIZE	QTY./CARTON
79626	1400W	1

149CC

INDUSTRIAL



GASOLINE BLOWER

1HP

- Engine capacity: 25.4cc
- Powerful 2-stroke engine
- Rated power: 750W
- Powerful 2-stroke air-cooled gasoline engine
- Air volume: 520m³/h
- Fuel tank capacity: 0.4L
- Net weight: 5.5kg
- Starting type: recoil start
- Features:
 - The Leaf Blower comes complete with everything you need to get started clearing the leaves and mess around your property.
 - Designed for both professional and home users, the machine is powerful enough to tackle any task however big or small.
 - Supplied with a high quality, adjustable backpack harness, it is comfortable to use for extended periods of time.
 - Easy to start and operate, with an adjustable outlet length.
- Package Content:
 - 1pc dust bag
 - 1pc vacuum tube
 - 1pc funnel
 - 1pc oil bottle
 - Packing: color box

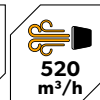

STOCK NO.	Engine capacity	QTY./CARTON
79628	25.4cc	1

GASOLINE BLOWER

3.6HP

- Engine capacity: 63.3cc
- Powerful 2-stroke engine
- Rated power: 2700W
- Powerful 2-stroke air-cooled engine
- Air volume: 1440m³/h
- Fuel tank capacity: 1.6L
- Net weight: 10.5kg
- Starting type: recoil start
- Features:
 - The Leaf Blower comes complete with everything you need to get started clearing the leaves and mess around your property.
 - Designed for both professional and home users, the machine is powerful enough to tackle any task however big or small.
 - Supplied with a high quality, adjustable backpack harness, it is comfortable to use for extended periods of time.
 - Easy to start and operate, with an adjustable outlet length.
- Package Content:
 - 1pc spark plug socket wrench
 - 2pcs hex key S4/S5
 - 1pc spanner 8x10mm
 - 1pc funnel
 - 1pc oil bottle
 - Packing: color box

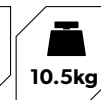
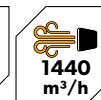
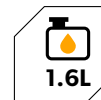

STOCK NO.	Engine capacity	QTY./CARTON
79629	63.3cc	1



INDUSTRIAL

GASOLINE CHAIN SAW

3HP

- Engine capacity: 52cc
- Powerful 2-stroke engine
- Rated power: 2200W/3HP
- Idling speed: 3000/min
- Bar length: 500mm / 20"
- Chain pitch: 3/8" (0.375")
- Fuel tank capacity: 550ml
- Oil tank capacity: 260ml
- Long life airfilter, can be cleaned repeatedly free for filter replacing
- Easy starting
- Automatic choke
- 4 points shock absorption design
- Packed by color box



STOCK NO.	SIZE	QTY./CARTON
79611	52cc	2

550ml 20" 500mm 3000/min 2-STROKE AIR-COOLED GASOLINE ENGINE

INDUSTRIAL

GASOLINE CHAIN SAW

2.6HP

- Engine capacity: 52cc
- Powerful 2-stroke engine
- Rated power: 2000W/2.6HP
- Idling speed: 3000/min
- Bar length: 500mm / 20"
- Chain pitch: 0.325"
- Fuel tank capacity: 550ml
- Oil tank capacity: 260ml
- Easy starting
- 4 points shock absorption design
- Packed by color box



STOCK NO.	SIZE	QTY./CARTON
79614	52cc	2

550ml 20" 500mm 3000/min 2-STROKE AIR-COOLED GASOLINE ENGINE

PETROL BRUSH CUTTER AND LINE TRIMMER

2HP

- Engine capacity: 43cc
- Powerful 2-stroke engine
- Rated power: 1500W/2HP
- Idling speed: 3000/min
- Cutting width of trimmer: Ø460mm
- Line: Ø2.4mmx5m
- Cutting width of blade: 255mm(3teeth)
- Shaft length: 1.5m
- Fuel tank capacity: 1.2L
- Easy starting
- Double safety shoulder harness with quick release mechanism
- Packed by color box in carton box



STOCK NO.	SIZE	QTY./CARTON
79620	43cc	1

1.2L Ø460mm 255mm (3teeth) 3000/min 2-STROKE AIR-COOLED GASOLINE ENGINE

INDUSTRIAL

TRIMMER LINE

- Material: Nylon 6
- Packing: paper card



STOCK NO.	COLOR	SIZE	QTY./CARTON
77652	GREEN	2.0mmx15m / 0.08"x50ft	120
77654	ORANGE	2.4mmx15m / 0.095"x50ft	120
77656	RED	2.7mmx15m / 0.105"x50ft	120
77658	YELLOW	3.0mmx15m / 0.12"x50ft	120

TRIMMER LINE (SQUARE SHAPE)

- Material: Nylon 6
- Packing: paper card

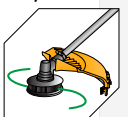

STOCK NO.	COLOR	SIZE	QTY./CARTON
77653	GREEN	2.0mmx15m / 0.08"x50ft	120
77655	ORANGE	2.4mmx15m / 0.095"x50ft	120
77657	RED	2.7mmx15m / 0.105"x50ft	120
77659	YELLOW	3.0mmx15m / 0.12"x50ft	120

TROWEL

- Drop forged special tool steel
- Black powder coated
- Total length: 330mm
- Thickness: 1.5mm
- Two-component plastic handle
- Packing: hang tag



STOCK NO.	SIZE	QTY./CARTON
57500	80x152mm	60

TRANSPLANTER

- Drop forged special tool steel
- Black powder coated
- Total length: 330mm
- Thickness: 1.5mm
- Two-component plastic handle
- Packing: hang tag



STOCK NO.	SIZE	QTY./CARTON
57502	55x152mm	60

CULTIVATOR

- Drop forged special tool steel
- Black powder coated
- Total length: 285mm
- Diameter of main rod: 8mm
- Two-component plastic handle
- Packing: hang tag



STOCK NO.	SIZE	QTY./CARTON
57504	55x90mm	60

FORK

- Drop forged special tool steel
- Black powder coated
- Total length: 310mm
- Thickness: 2.5mm
- Two-component plastic handle
- Packing: hang tag



STOCK NO.	SIZE	QTY./CARTON
57506	76x120mm	60

3-LINE FORK AND HOE

- Drop forged special tool steel
- Black powder coated
- Total length: 310mm
- Diameter of main rod: 8mm
- Two-component plastic handle
- Packing: hang tag



STOCK NO.	SIZE OF HOE	SIZE OF FORK	QTY./CARTON
57508	76x120mm	90x92mm	48

GARDEN RAKE

- 9 teeth
- Size of each tooth: 6.0x1.0mm
- Drop forged special tool steel
- Black powder coated
- Total length: 350mm
- Thickness: 2.5mm
- Two-component plastic handle
- Packing: hang tag



STOCK NO.	SIZE	QTY./CARTON
57510	155mm	60

EXPANDABLE HOSE

- Size: 5m
- Stretch to 3 times its length
- Super light weight and easy to store
- Hose will expand as you stretch it
- None kinking
- With 8 pattern nozzle
- With hose connector 1/2"-3/4"
- Packing: color box



STOCK NO.	SIZE	QTY./CARTON
57250	5m	12

GARDEN SPRAYER

- Material: PE
- Brass nozzle
- Maximum working pressure: 2.0 Bar
- Packing: plastic bag



STOCK NO.	SIZE	QTY./CARTON
57281	2L	12

GARDEN SPRAYER

- Material: PE
- With belt
- Maximum working pressure: 2.5 Bar
- Packing: color box



STOCK NO.	SIZE	QTY./CARTON
57292	5L	6

GARDEN SPRAYER

- PE body PP accessories, glass fiber spray bar
- 1.5m leather tube
- With belt
- Working pressure: 0.2-0.4MPa
- Packing: color box



STOCK NO.	SIZE	QTY./CARTON
57295	16L	1

8 PATTERN NOZZLE

- 8 selectable patterns: full, angle, shower, mist, center, flat, cone, soaker
- Durable ABS body with TPR comfort grip
- Packing: skin card

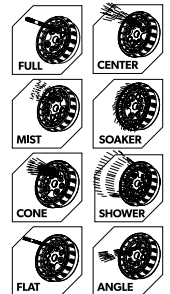

STOCK NO.	QTY./CARTON
57100	48

ADJUSTABLE NOZZLE

- Adjustable from fine mist to powerful jet stream
- Durable ABS body with TPR comfort grip
- Packing: skin card



STOCK NO.	QTY./CARTON
57101	48

THE TOLSEN WATERING SYSTEM

Diagram is illustrative only to show which parts to use in which location

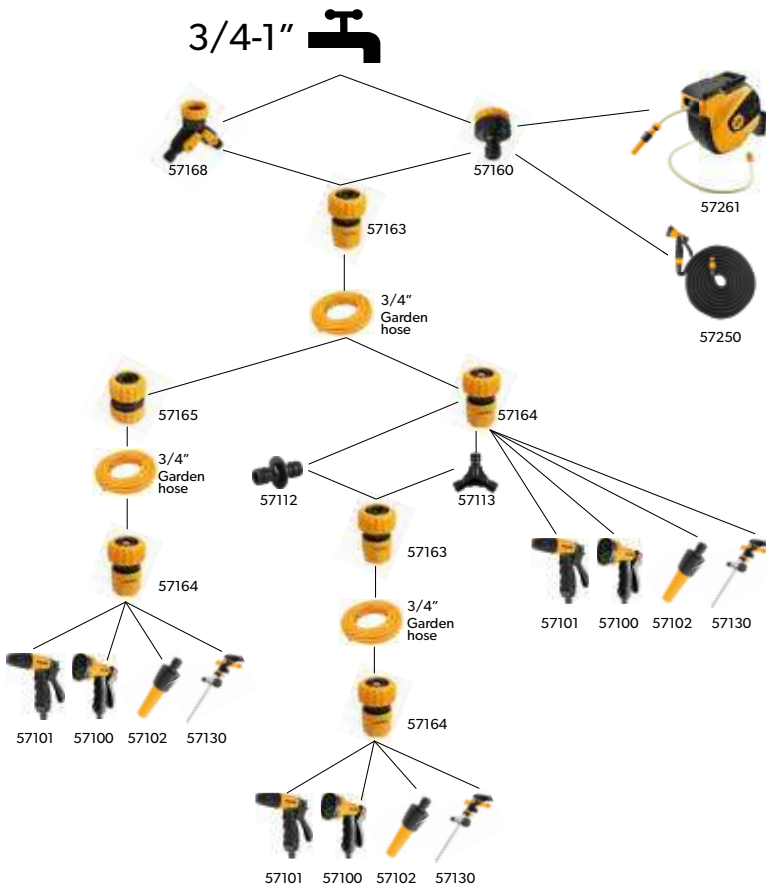
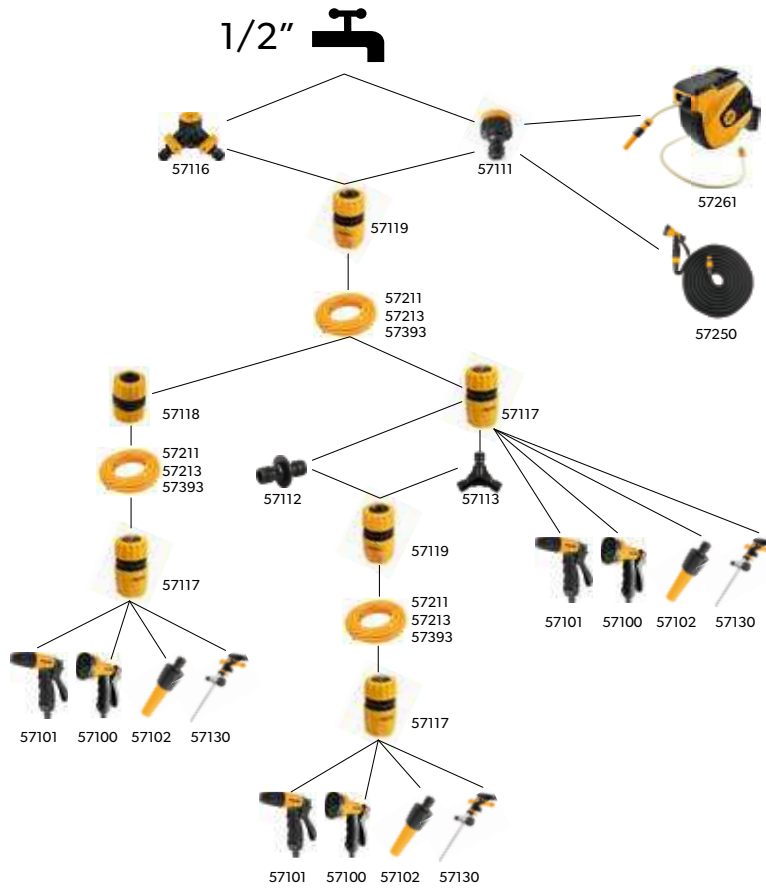

ADJUSTABLE NOZZLE

- Adjustable from fine mist to powerful jet stream
- Durable ABS body with PP material
- Global quick connect adapter
- Packing: skin card



STOCK NO.	QTY./CARTON
57102	96

2 WAY COUPLING

- Material: ABS
- Packing: skin card



STOCK NO.	QTY./CARTON
57112	120

3 WAY COUPLING

- Material: ABS
- Packing: skin card

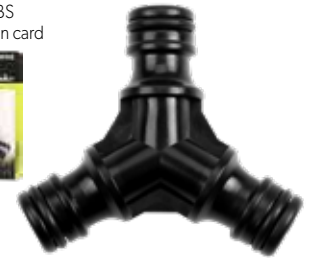

STOCK NO.	QTY./CARTON
57113	120

Y-SWITCH COUPLING WITH SWIVEL

- Material: ABS
- Packing: skin card



STOCK NO.	SIZE	QTY./CARTON
57116	1/2"	120

TAP ADAPTOR

- Material: ABS
- Packing: skin card



STOCK NO.	SIZE	QTY./CARTON
57111	1/2"- 3/4"	120

1/2" HOSE MENDER

- Material: PP
- Packing: skin card



STOCK NO.	SIZE	QTY./CARTON
57118	1/2"	120

HOSE CONNECTOR WITH WATER STOP

- Material: PP+ABS
- Packing: skin card



STOCK NO.	SIZE	QTY./CARTON
57117	1/2"	120

HOSE CONNECTOR

- Material: PP+ABS
- Packing: skin card



STOCK NO.	SIZE	QTY./CARTON
57119	1/2"	120

TAP ADAPTOR

- Material: ABS
- Packing: skin card



STOCK NO.	SIZE	QTY./CARTON
57160	3/4"-1"	120

HOSE MENDER

- Material: PP+ABS
- Packing: skin card



STOCK NO.	SIZE	QTY./CARTON
57165	3/4"	120

HOSE CONNECTOR WITH WATER STOP

- Material: PP+ABS
- Packing: skin card



STOCK NO.	SIZE	QTY./CARTON
57164	3/4"	120

HOSE CONNECTOR

- Material: PP+ABS
- Packing: skin card



STOCK NO.	SIZE	QTY./CARTON
57163	3/4"	120

DOUBLE TAP CONNECTOR

- Material: PP+ABS
- Packing: skin card



STOCK NO.	SIZE	QTY./CARTON
57168	3/4" - 1"	120

4PCS HOSE CONNECTOR SET

- 1pc 3/4" Hose Connector
- 1pc 3/4" Hose Connector with Water Stop
- 1pc 3/4" - 1" tap Adaptor
- 1pc adjustable nozzle
- Packing: skin card



STOCK NO.	SIZE	QTY./CARTON
57171	3/4"	48

3PCS HOSE CONNECTOR

- 1pc 1/2" Hose Connector
- 1pc 1/2" Hose Connector with Water Stop
- 1pc 1/2"-3/4" tap Adaptor
- Packing: skin card



STOCK NO.	SIZE	QTY./CARTON
57120	1/2"	48

4PCS HOSE CONNECTOR

- 1pc 1/2" Hose Connector
- 1pc 1/2" Hose Connector with Water Stop
- 1pc 1/2"-3/4" tap Adaptor
- 1pc 1/2" adjustable nozzle
- Packing: skin card



STOCK NO.	SIZE	QTY./CARTON
57125	1/2"	48

IMPULSE SPRINKLER

- Plastic impulse sprinkler with zinc spike
- Circle or part circle operation
- Spray coverage is up to 24 meter diameter
- Material: Brass, Zinc alloy
- Packing: paper hanger



STOCK NO.	SIZE	QTY./CARTON
57130	1/2"	48

GARDEN HOSE

- Material: PVC with polyester yarn reinforcement
- Packing: color paper with shrink



STOCK NO.	SIZE	MAXIMUM WORKING PRESSURE	QTY./ CARTON
57211	1/2"x15m	400psi	10
57213	1/2"x30m	400psi	5
57393	5/8"x50m	300psi	2

HOSE REEL

- Material: PP
- Fits hose size up to 1/2"x45m
- Folding handle
- Simple click and lock assembly
- Packing: color box

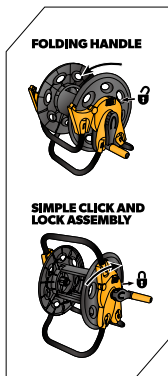

STOCK NO.	SIZE	QTY./CARTON
57221		5

AUTOMATIC HOSE REEL SET

- Oversize: 53x49x23cm
- Hose can be locked at any length
- With slow retraction function
- Packing: color box

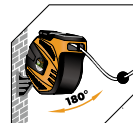

THE 180° SWIVELED BRACKET IS REACHABLE



HANDLE EASY MOVING



LOCK AT ANY LOCATIONS SLOW RESILIENCE

STOCK NO.	HOSE SIZE	QTY./ CARTON
57261	1/2"x 15M+1.5m/50FT	1

GARDEN GLOVES

- Weight: 700g/doz
- Material: cotton and polyester, class A
- Knitted wrist
- One dozen in a polybag with color sticker



x12

STOCK NO.	SIZE	QTY./CARTON
45006	10(XL)	10

BOW SAW

- Handle hack saw frame
- Including 1pc saw blade (B-type)
- Packing: color label



COMFORTABLE AND SAFETY GRIP



STOCK NO.	SIZE	QTY./CARTON
31081	530mm,21"	18
31082	610mm,24"	12

GARDEN SAW BLADE (FOR DRY)

- A-type double side grinding teeth
- High frequency hardened
- 65Mn blade
- Packing: color sleeve



STOCK NO.	SIZE	QTY./CARTON
31099	530mm,21"	200
31100	610mm,24"	200

GARDEN SAW BLADE (FOR WET)

- B-type double side grinding teeth
- High frequency hardened
- 65Mn blade
- Packing: color sleeve



STOCK NO.	SIZE	QTY./CARTON
31105	530mm,21"	200
30106	610mm,24"	200

FOLDABLE SAW

- 7TPI 65Mn blade
- Two-component plastic handle
- Packing: blister card



STOCK NO.	BLADE LENGTH	THICKNESS	QTY./ CARTON
31014	180mm,7"	1.2mm	24

PRUNING SAW

- 6TPI 65Mn blade
- Two-component plastic handle
- Packing: color sleeve



STOCK NO.	BLADE LENGTH	THICKNESS	QTY./ CARTON
31045	350mm,14"	1.2mm	40

PRUNING SAW

NEW

- 6TPI 65Mn blade
- With Two-component plastic handle
- Can fit with 31049 telescopic handle
- With plastic scabbard
- Packing: color label



STOCK NO.	BLADE LENGTH	THICKNESS	QTY./ CARTON
31046	350mm,14"	1.2mm	40

HAND SAW

- 7TPI
- 65Mn blade, heat treated
- With teeth protector
- Packing: color sleeve



FASTER CUTTING

STOCK NO.	SIZE	QTY./CARTON
31070	400mm,16"	40
31071	450mm,18"	40
31072	500mm,20"	40
31073	550mm,22"	40

BYPASS PATTERN PRUNING SHEAR

- Fine polished
- Dipped handle
- Packing: blister card



STOCK NO.	SIZE	MAX. CUTTING CAP.	QTY./ CARTON
31018	200mm,8"	19mm, 3/4"	60

STRAIGHT PRUNING SHEAR

- Fine polished
- Dipped handle
- Packing: blister card



STOCK NO.	SIZE	QTY./CARTON
31019	200mm,8"	60

STRAIGHT PRUNING SHEAR

- Stainless steel blade, fine polished
- Zinc alloy handle, with PVC grips
- Packing: blister card



STAINLESS STEEL

STOCK NO.	SIZE	QTY./CARTON
31031	200mm,8"	60

BYPASS PATTERN PRUNING SHEAR

- Stainless steel blade, fine polished
- Zinc alloy handle, with PVC grips
- Packing: blister card



STAINLESS STEEL

STOCK NO.	SIZE	MAX. CUTTING CAP.	QTY./ CARTON
31032	200mm,8"	19mm, 3/4"	60

ANVIL PATTERN PRUNING SHEAR

- 65Mn blade
- Plastic handle
- Packing: blister card



STOCK NO.	SIZE	MAX. CUTTING CAP.	QTY./ CARTON
31020	200mm,8"	16mm, 5/8"	60

BYPASS PATTERN PRUNING SHEAR

- 65Mn blade
- Plastic handle
- Packing: blister card



STOCK NO.	SIZE	MAX. CUTTING CAP.	QTY./ CARTON
31021	200mm,8"	16mm, 5/8"	60

BYPASS PATTERN PRUNING SHEAR

- SK5 blade
- Dipped handle
- Packing: blister card



SK5

STOCK NO.	SIZE	MAX. CUTTING CAP.	QTY./ CARTON
31022	200mm,8"	12.7mm, 1/2"	60

ALUMINIUM BODY GEAR PRUNING SHEAR

- 65Mn blade
- Teflon coated
- Packing: silding card



STOCK NO.	SIZE	MAX. CUTTING CAP.	QTY./ CARTON
31023	200mm,8"	25mm, 1"	60

HEDGE SHEAR

- Telescopic steel tube handle
- PVC grip
- Packing: PVC bag



STOCK NO.	SIZE	QTY./CARTON
31024	26"-36"	12

LOPPING SHEAR

- Telescopic steel tube handle
- PVC grip
- Packing: PVC bag



STOCK NO.	SIZE	MAX. CUTTING CAP.	QTY./ CARTON
31025	24"-36"	44.4mm, 1-3/4"	12

PLASTIC LEAF RAKE

- 22 teeth plastic rake
- Fixed to natural wood handle
- Total length: 1580mm
- Packing: color label

PLASTIC

22 TEETH



STOCK NO.	WIDTH	QTY./CARTON
57550	510mm	18

FLEXIBLE METAL LAWN RAKE

- 24T
- 1370mm wooden handle
- Packing: color label

FLEXIBLE METAL

24 TEETH



STOCK NO.	WIDTH	QTY./CARTON
57555	580mm	12

STEEL SHOVEL WITH HANDLE

- Wooden handle
- Shovel weight:1kg
- Shovel head width:215mm
- Shovel head length:295mm
- Material: carbon steel
- Packing: color label



STOCK NO.	LENGTH	QTY./CARTON
58001	1025mm	6

STEEL SHOVEL WITH HANDLE

- Wooden handle
- Shovel weight:1kg
- Shovel head width:235mm
- Shovel head length:280mm
- Material: carbon steel
- Packing: color label



STOCK NO.	LENGTH	QTY./CARTON
58002	1025mm	6

STEEL SHOVEL WITH HANDLE

- Wooden handle
- Shovel weight:1kg
- Shovel head width:215mm
- Shovel head length:295mm
- Material: carbon steel
- Packing: color label



STOCK NO.	LENGTH	QTY./CARTON
58005	1480mm	6

STEEL SHOVEL WITH HANDLE

- Wooden handle
- Shovel weight:1kg
- Shovel head width:235mm
- Shovel head length:280mm
- Material: carbon steel
- Packing: color label



STOCK NO.	LENGTH	QTY./CARTON
58006	1480mm	6

PROFESSIONAL TREE PRUNER

- 65Mn saw blade and triple teeth grounded
- Saw blade length: 300mm
- 65Mn curved pruning shear blade with teflon treatment
- Max cutting diameter:35mm
- 2.5m nylon strings
- Double wheels design
- Packing: double blister



65Mn
HEAT-TREATED
BLADE

35 mm
MAX. CUTTING
DIAMETER

2.5M
HIGH
STRENGTH
NYLON ROPE

STOCK NO.	SIZE	QTY./CARTON
31048	300mm, 12"	10

TELESCOPIC HANDLE

- High quality iron material with yellow powder coated surface
- Two sections contraction
- Expansion Length: 2.4m
- Retracted Length: 1.29m
- Can be locked at any length
- Suitable for TOLSEN
- 31048, 31045, 31046
- Packing: color label



STOCK NO.	LENGTH	QTY./CARTON
31049	1.2-2.4m	10

FINISHING TOOLS



STEEL FILES

- Flat
- T12 special tool steel
- Two-component plastic handle
- Packing: plastic hanger



STOCK NO.	SIZE	QTY./CARTON
32001	200mm,8"	100

STEEL FILES

- Half round
- T12 special tool steel
- Two-component plastic handle
- Packing: plastic hanger



STOCK NO.	SIZE	QTY./CARTON
32005	200mm,8"	100

STEEL FILES

- Round
- T12 special tool steel
- Two-component plastic handle
- Packing: plastic hanger



STOCK NO.	SIZE	QTY./CARTON
32009	200mm,8"	100

STEEL FILES

- Triangular
- T12 special tool steel
- Two-component plastic handle
- Packing: plastic hanger



STOCK NO.	SIZE	QTY./CARTON
32013	200mm,8"	100

STEEL FILES

- Square
- T12 special tool steel
- Two-component plastic handle
- Packing: plastic hanger



STOCK NO.	SIZE	QTY./CARTON
32017	200mm,8"	100

WOOD FILES

- Flat
- Special tool steel
- Two-component plastic handle
- Packing: plastic hanger



STOCK NO.	SIZE	QTY./CARTON
32021	200mm,8"	100

WOOD FILES

- Half round
- Special tool steel
- Two-component plastic handle
- Packing: plastic hanger



STOCK NO.	SIZE	QTY./CARTON
32025	200mm,8"	100

WOOD FILES

- Round
- Special tool steel
- Two-component plastic handle
- Packing: plastic hanger



STOCK NO.	SIZE	QTY./CARTON
32029	200mm,8"	100

3PCS STEEL FILE SET

- Flat, Half round, Round
- T12 special tool steel
- Two-component plastic handle
- Packing: blister card



STOCK NO.	SIZE	QTY./CARTON
32033	200mm,8"	40

3PCS WOOD FILE SET

- Flat, Half round, Round
- Special tool steel
- Two-component plastic handle
- Packing: blister card



STOCK NO.	SIZE	QTY./CARTON
32037	200mm,8"	40

5PCS FILE SET

- Steel files, T12 special tool steel
Flat;Half round;Round;Triangular
- Wood file, special tool steel,
Half round
- Two-component plastic handle
- Packing: double blister



STOCK NO.	SIZE	QTY./CARTON
32038	200mm,8"	16

6PCS NEEDLE FILE SET

- Flat, Flat Warding, Square, Triangular, Round, Half round
- Alloy steel
- Two-component plastic handle
- Packing: blister card

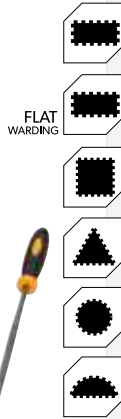

STOCK NO.	SIZE	QTY./CARTON
32046	3x100mm	100

COMBINATION SHARPENING STONES

- Grey aluminium oxide
- One side:120 grit
- One side:240 grit
- Packing: white box with color sticker



STOCK NO.	SIZE	QTY./CARTON
32047	150x50x25mm	50

SHARPENING STONES, OVAL SHAPE

- Silicon carbide oxide
- 120 grit
- Packing: white box with color sticker



STOCK NO.	SIZE	QTY./CARTON
32048	230x33x13mm	100

UNIVERSAL BRUSH

- Steel wire
- Plastic handle
- Packing: hang tag
- 24pcs in a display box



STOCK NO.	SIZE	QTY./CARTON
32060	250mm,10"	96

3PCS WIRE BRUSHES SET

- 1pc 180mm nylon brush
- 1pc 180mm steel brush
- 1pc 180mm stainless brush
- Plastic handle
- Packing: blister card



STOCK NO.	SIZE	QTY./CARTON
32059	3lines	120

WIRE BRUSH

- Straight and black wire
- Wooden handle
- Packing: hang tag



STOCK NO.	SIZE	QTY./CARTON
32061	3lines	120
32062	4lines	120
32063	5lines	120

WIRE BRUSH

- Curved and copper plating wire
- Wooden handle
- Packing: hang tag



STOCK NO.	SIZE	QTY./CARTON
32065	4lines	120
32066	5lines	120

PLASTIC SANDING BLOCK

- ABS case
- EVA bottom plate
- Packing: plastic bag with paper hanger



STOCK NO.	SIZE	QTY./CARTON
32100	165x85mm	60
32101	210x105mm	60

10PCS ABRASIVE PAPER SHEET SET

- For WET hand operations
- Size: 230x280mm(9"x11")
- Resin-bonded silicon carbide abrasive
- Packaging: 10pcs packed in a color paper bag



STOCK NO.	GRIT	QTY./CARTON
32401	60#	60
32402	80#	60
32403	100#	60
32404	120#	60
32405	150#	60
32406	180#	60
32407	220#	80
32408	240#	80
32409	280#	80
32410	320#	80
32411	360#	80
32412	400#	100
32413	500#	100
32414	600#	100
32415	800#	100
32416	1000#	100
32417	1200#	100
32418	1500#	100
32419	2000#	100

10PCS ABRASIVE PAPER SHEET SET

- For DRY hand operations
- Size: 230x280mm(9"x11")
- Resin-bonded aluminum oxide abrasive
- Packaging: 10pcs packed in a color paper bag



STOCK NO.	GRIT	QTY./CARTON
32451	40#	50
32452	60#	50
32453	80#	50
32454	100#	80
32455	120#	80
32456	150#	80
32457	180#	80
32458	220#	80
32459	240#	80



PLUMBING TOOLS



PVC PIPE CUTTER

- Automatic open function
- With blade quick change function
- Body Material: Aluminium die-casting, powder coated.
- 3Cr13 stainless steel blade, heat treatment HRC52-56.
- Apply to cut PVC, PPR, PU, PE and other plastic pipe.
- Packing: blister card



AUTOMATIC OPEN

STOCK NO.	SIZE	MAX. CUTTING DIA.	QTY./CARTON
33001	225mm,9"	42mm	24

PVC PIPE CUTTER

- 65Mn blade
- Automatic open function
- Body Material: Aluminium die-casting, powder coated
- Apply to cut PVC, PPR, PU, PE and other plastic pipe
- Packing: blister card

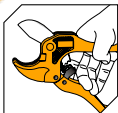

AUTOMATIC OPEN

STOCK NO.	SIZE	CUTTING DIA.	QTY./CARTON
33100	200mm,8"	3-42mm	48

PVC PIPE CUTTER

- Aluminium alloy body
- 65Mn blade
- Packing: blister card



STOCK NO.	SIZE	CUTTING DIA.	QTY./CARTON
33002	210mm,8"	3-35mm	72

PIPE CUTTER

- zinc alloy body
- Packing: blister card



STOCK NO.	CUTTING DIA.	QTY./CARTON
33003	3-22mm	80

PIPE CUTTER

- Aluminium alloy body
- Packing: blister card



STOCK NO.	CUTTING DIA.	QTY./CARTON
33004	3-28mm	50

PIPE CUTTER

- Zinc alloy body
- Packing: blister card



STOCK NO.	CUTTING DIA.	QTY./CARTON
33005	3-32mm	50

PIPE CUTTER

- Aluminium alloy body
- Packing: blister card



FOUR ROLLS FOR PRECISE

STOCK NO.	CUTTING DIA.	QTY./CARTON
33006	6-64mm	24

HEAVY DUTY PIPE CUTTER

- High quality special tool steel body, powder plated
- Bearing steel blade with heat treatment
- Plastic handle
- Can cut copper pipe & aluminium pipe & steel pipe
- Packing: color box



STOCK NO.	PIPE THREAD SIZE	CUTTING DIAMETER	QTY./CARTON
33009	1/8" - 1-1/4"	10-42mm	24

INDUSTRIAL

INDUSTRIAL

PVC PIPE THREADING SET

- Suitable for PVC pipes
- ABS handle
- Packing: Blister card

NPT



STOCK NO.	SIZE	QTY./CARTON
33008	1/2"-3/4"-1"	50

9PCS PIPE THREADING SET

- BSPT
- Black finish
- 1 ratcheting pipe threading system with 2 extension bars
- Packing: color box

INDUSTRIAL



BSPT



STOCK NO.	SIZE	QTY./CARTON
33011	1/4", 3/8", 1/2", 3/4", 1", 1-1/4"	2

PTFE TAPE

- 100% PTFE



STOCK NO.	SIZE	QTY./CARTON
33013	12mm x 0.075 mm x 10m x 0.35g / cm ³	600

5PCS SCREW EXTRACTOR SET

- High quality alloy steel
- Black finished
- Packing: blister card

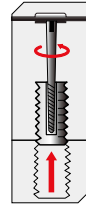

STOCK NO.	SIZE	QTY./CARTON
33505	1#, 2#, 3#, 4#, 5#	40

PIPE WELDING MACHINE SET

- CE approval
- Input power: 700W / 1500W
- Voltage: 230V
- Frequency: 50Hz
- Heating sockets: 20, 25, 32, 40, 50, 63mm;
- Thermoregulator: 0 °C - 300 °C
- Applying to: PP-R, PB, PE, PE-RT
- Aluminium die casting base
- Plug & cable: CE approved 1.8m
- Accessories:
 - 1pc measuring tape 3meter
 - 1pc PVC pipe cutter 3-42mm
 - 1pc screwdriver PH1x100mm
- Packing: steel box with color paper and shrink



STOCK NO.	SIZE	QTY./CARTON
33021	700W / 1500W	3

PIPE WELDING MACHINE SET

- CE approval
- Input power: 800w
- Voltage: 230V
- Frequency: 50Hz
- Heating sockets: 20, 25, 32, 40, 50, 63mm;
- Thermoregulator: 0 °C - 300 °C
- Applying to: PP-R, PB, PE, PE-RT
- Plug & cable: CE approved 1.8m
- Packing: steel box with color paper and shrink



STOCK NO.	SIZE	QTY./CARTON
33022	800W	6



MEASURING TOOLS

MEASURING TAPE

- With metric blade
- Accuracy: MID Class II
- Power return blade has clear graduations with yellow wear resistant coating
- ABS plastic tape case with locking button and belt clip
- Self-aligning end hook for accurate internal/external measurements
- Packing: plastic hanger with color box

MIDI

METRIC



STOCK NO.	SIZE	QTY./CARTON
35991	3M x 16mm	120
35992	5M x 19mm	72
35994	7.5M x 25mm	36

MEASURING TAPE

- With metric / inch blade
- Accuracy: MID Class II
- Power return blade has clear graduations with yellow wear resistant coating
- Tough impact resistant ABS case with rubber soft grip
- With 3 locking button and belt clip
- Self-aligning end hook for accurate internal/external measurements
- Packing: plastic hanger with color box

MIDI

METRIC

INCH



STOCK NO.	SIZE	QTY./CARTON
35006	3M/10ft x 16mm	120
35007	5M/16ft x 19mm	72
35008	8M/26ft x 25mm	36

MEASURING TAPE

- With metric blade
- Accuracy: MID Class II
- Power return blade has clear graduations with yellow wear resistant coating
- Tough impact resistant ABS case with rubber soft grip
- With 3 locking button and belt clip
- Self-aligning end hook for accurate internal/external measurements
- Packing: plastic hanger with color box

MIDI

METRIC



STOCK NO.	SIZE	QTY./CARTON
35981	3M x 16mm	120
35982	5M x 19mm	72
35984	8M x 25mm	36

MEASURING TAPE

- ABS case covered with TPR
- Comfortable holding feel and impact resistant
- Both sides coat nylon of the blade
- Manual powerful stop button
- With metric and inch blade
- Accuracy: MID class II
- With magnetic hook
- Packing: color sticker with PP card



COMFORTABLE HOLDING FEEL AND IMPACT RESISTANT



NYLON COATED BLADE



MAGNETIC HOOK



MIDI



METRIC

INCH

STOCK NO.	SIZE	QTY./CARTON
36002	3M/10ft x 16mm	72
36004	5M/16ft x 25mm	48
36005	8M/26ft x 25mm	36
36006	10M/33ft x 25mm	36

MEASURING TAPE

- Accuracy: MID class II
- With metric blade
- Self lock function
- ABS case covered with TPR
- Comfortable holding feel and impact resistant
- Lock automatically, convenient to use
- Packing: color label

MIDI

SELF LOCK

SUPER COATED

IMPACT RESISTANT



METRIC

STOCK NO.	SIZE	QTY./CARTON
36012	3M x 16mm	96
36013	5M x 19mm	60
36014	5M x 25mm	48
36015	8M x 25mm	36
36016	10M x 25mm	36

FIBREGLASS MEASURING TAPE

- ABS case covered with TPR
- Comfortable holding feel and impact resistant
- Fiberglass tape with PVC coated blade
- With metric blade
- Four times of quick rewinding
- Packing: color box



INDUSTRIAL

METRIC

DOUBLE SIDED PRINTING



STOCK NO.	SIZE	QTY./CARTON
35017	20M x 15mm	40
35018	30M x 15mm	24
35019	50M x 15mm	16

FIBREGLASS MEASURING TAPE

- ABS case with a nickel plated winding handle
- With metric and inch blade
- Packing: color box



METRIC

INCH

DOUBLE SIDED PRINTING



STOCK NO.	SIZE	QTY./CARTON
35020	20M/66ft x 12.5mm	48
35022	30M/100ft x 12.5mm	40
35023	50M/165ft x 12.5mm	24

STEEL MEASURING TAPE

- With metric and inch steel blade
- Pure material retracting gear
- 4:1 Gear ratio for fast rewind
- With all ABS cover
- Integrated handle good for using and convenient storing
- Ergonomic handle
- Packing: color box



INDUSTRIAL

4x
FASTER
REWIND

METRIC

INCH

STOCK NO.	SIZE	QTY./CARTON
35013	30m x 12.5mm, 100ft x 1/2"	10
35014	50m x 12.5mm, 165ft x 1/2"	10

STAINLESS STEEL RULER

- Stainless steel(2Cr13)
- Packing: PVC bag with color label



METRIC

INCH

STOCK NO.	SIZE	WIDTH	THICKNESS	QTY./CARTON
35024	150mm,6"	19mm	0.8mm	500
35026	300mm,12"	25mm	1.0mm	250
35028	600mm,24"	30mm	1.2mm	120
35030	1000mm,40"	32mm	1.5mm	60

ADJUSTABLE BEVEL

- Stainless steel(2Cr13)
- ABS handle
- With spirit level
- Packing: color label



WITH SPIRIT LEVEL

STOCK NO.	SIZE	QTY./CARTON
35035	200mm,8"	72

ANGLE SQUARE

- Aluminium handle
- Powder coated finish
- Packing: hang tap with PE bag



METRIC

INCH

STOCK NO.	SIZE	QTY./CARTON
35080	250mm,10"	120
35081	300mm,12"	120

ALUMINIUM ALLOY ANGLE SQUARE

- Stainless alloy body (2Cr13)
- Aluminium base
- Packing: paper hanger



METRIC

INCH

STOCK NO.	SIZE	WIDTH	THICKNESS	QTY./CARTON
35038	250mm,10"	36mm	1.0mm	60
35039	300mm,12"	36mm	1.0mm	60

INDUSTRIAL

COMBINATION SQUARE

- Cast zinc body
- Stainless steel blade
- Metric and Inch size
- Brass adjusting screw
- With spirit level and scriber
- Packing: paper card

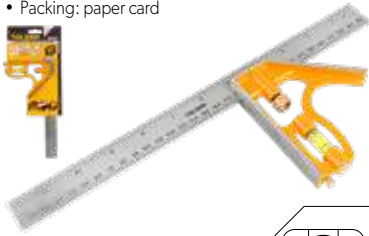

METRIC

INCH

STOCK NO.	SIZE	QTY./CARTON
35037	250mm, 10"	120

ANGLE SQUARE

- Powder coated finish
- Packing: color label

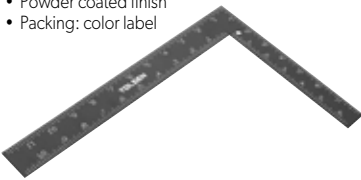

METRIC

INCH

STOCK NO.	SIZE	THICKNESS	QTY./CARTON
35042	200x300mm 8"x12"	1.8mm	60
35043	400x600mm 16"x24"	1.8mm	24

FEELER GAUGES

- 100mm, 13blatt
- Chrome plated case
- Polishing finished
- Packing: color box

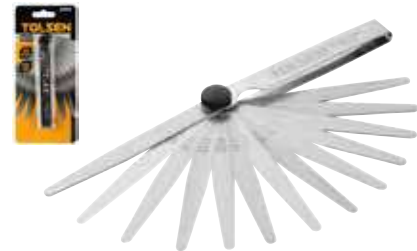

STOCK NO.	SIZE	QTY./CARTON
35044	0.05-1.00mm	100

WOOD FOLDING RULER

- Accuracy: MID class III
- High quality fine polished wood body with spring
- Packing: paper hanger



MIDIII

METRIC

STOCK NO.	SIZE	QTY./CARTON
35046	2m	100

FOLDING RULER

- ABS body with spring
- Packing: paper hanger



METRIC

INCH

STOCK NO.	SIZE	QTY./CARTON
35047	2m / 80"	120

VERNIER CALIPER

- Accuracy: 0.05mm
- Special tool steel, chrome plated
- Four-way measurement
- Packing: plastic case with color sleeve



METRIC

STOCK NO.	SIZE	QTY./CARTON
35048	150mm	40

VERNIER CALIPER

- Accuracy: 0.05mm, 1/128"
- Carbon steel, chrome plated
- Four-way measurement
- Packing: plastic case with color sleeve



METRIC

INCH

STOCK NO.	SIZE	QTY./CARTON
35049	150mm, 6"	40

DIGITAL CALIPER

- Accuracy: 0.01mm
- Stainless steel
- Four-way measurement
- Packing: plastic case with color sleeve



METRIC

INCH

STOCK NO.	SIZE	QTY./CARTON
35053	150mm, 6"	40

MICROMETER

- Accuracy: 0.01mm
- Carbide measuring face
- Chrome-plated frame
- Ratchet stop
- Packing: plastic case with color sleeve



METRIC

STOCK NO.	SIZE	QTY./CARTON
35055	0-25mm	50

MINI SPIRIT LEVEL

- Aluminium
- With 3 bubbles
- Accuracy: 1.0mm/m
- Packing: color sleeve



STOCK NO.	SIZE	QTY./CARTON
35059	22.5cm, 9"	60

MINI SPIRIT LEVEL

- Aluminium
- With 3 bubbles
- Accuracy: 1.0mm/m
- Packing: color sleeve



STOCK NO.	SIZE	QTY./CARTON
35210	22.5cm, 9"	60

BRIDGE SPIRIT LEVEL

- Aluminium frame
- With 2 bubbles, horizontal & vertical resp
- Packing: color sleeve



INDUSTRIAL

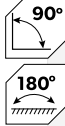

STOCK NO.	SIZE	QTY./CARTON
35060	40cm	20
35062	50cm	20
35061	60cm	20

SPIRIT LEVEL

- Aluminum frame with scale reading
- Powder coated surface
- Thickness: 1.0mm
- Accuracy: 1.0mm/m
- Three vial : 90°, 180°, 45°
- Packing: shrink

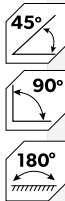

STOCK NO.	SIZE	QTY./CARTON
35221	40cm, 16"	50
35223	60cm, 24"	50
35224	80cm, 32"	30
35225	100cm, 40"	30
35226	120cm, 48"	20
35227	150cm, 60"	20
35229	200cm, 80"	20

SPIRIT LEVEL WITH MAGNETIC

- With magnetic
- Spirit level (industrial quality)
- Heavy duty aluminium frame
- Thickness: 1.5mm
- Accuracy: 0.5mm /m
- Three vial: 90°, 180°, 45°
- Two milled surface
- Humanized rubber handle
- Anti-shock end caps
- Packing: shrink



INDUSTRIAL

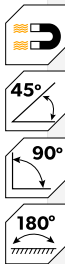

STOCK NO.	SIZE	QTY./CARTON
35111	40cm, 16"	20
35112	60cm, 24"	20
35113	80cm, 32"	20
35114	100cm, 40"	20
35115	120cm, 48"	20

SPIRIT LEVEL

- Heavy duty Aluminum frame with powder coated
- Miled bottom for high accuracy
- Accuracy: 0.5 mm/m
- Three vial : 90°, 180°, 45°
- Larger solid acrylic vial
- Dual view vial function for a true plumb reading
- Shockproof end caps
- Packing: shrink



INDUSTRIAL

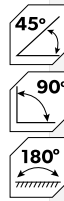

STOCK NO.	SIZE	QTY./CARTON
35231	40cm, 16"	20
35233	60cm, 24"	20
35234	80cm, 32"	20
35235	100cm, 40"	20
35236	120cm, 48"	20
35237	150cm, 60"	20
35238	180cm, 72"	20
35239	200cm, 80"	20

SPIRIT LEVEL WITH MAGNETIC

- Heavy duty Aluminum frame with powder coated
- Miled bottom for high accuracy
- Accuracy: 0.5 mm/m
- Three vial : 90°, 180°, 45°
- Larger solid acrylic vial
- Dual view vial function for a true plumb reading
- With 2pcs strong magnets
- Shockproof end caps
- Packing: shrink



INDUSTRIAL

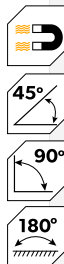

STOCK NO.	SIZE	QTY./CARTON
35243	60cm, 24"	20
35246	120cm, 48"	20

3D LASER LEVEL

- 3 x 360° Multiple line switching functions
- Power Source: Li-ion battery, with USB charging
- Laser unit: Osram
- Wavelength: 520nm Green light
- Beam Accuracy: H/V Line ±3mm/10m
- Expanded Angle: H&V 360°
- Max. working distance: 30m(without detector)
- Operating time: 1C: 15h / 2C: 10h / 3C: 5h
- Ingression Protection Rate: IP54
- Operating Temperature: -10°C - +50°C
- Storage Temperature: -20°C - +70°C
- Outdoor pulse mode
- 1pc instrument tripod with 1/4" and 5/8" threaded holes at bottom
- 1pc back clip
- 1pc 3.7V lithium battery + charging cable
- 1pc green target board
- 1pc green glass
- Packing: blow mould case

INDUSTRIAL

NEW

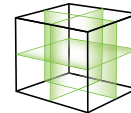

3x360°

Multiple line switching functions



STOCK NO.	WAVELENGTH	MAX. WORKING DISTANCE	QTY./CARTON
35155	Green 520nm	30m	5

SELF-LEVELING CROSS-LINE LASER LEVEL

- Provides maximum line visibility in standard working conditions
- Easy-to-Use Laser Setup Modes—Projects vertical, horizontal and cross lines. Lines can be projected separately or together for a variety of level and alignment applications
- Self-levels and indicates out-of-level condition; locks when switched off for secure laser transport
- Manual Mode—Locks lines for use at any angle
- Include a positioning device with strong magnets
- Red beam laser
- Wavelength: 635nm
- Beam Accuracy: H/V Line $\pm 3\text{mm}/10\text{m}$
- Expanded Angle: H&V 120°
- Max. working distance: 20m
- Power Supply: 2xAA battery(Not included)
- Operating time: 8h
- Ingression Protection Rate: IP54
- Operating Temperature: $-10^\circ\text{C} - +50^\circ\text{C}$
- Storage Temperature: $-20^\circ\text{C} - +70^\circ\text{C}$
- Model Function: switchable manual model
- Packing: canvas bag with color box

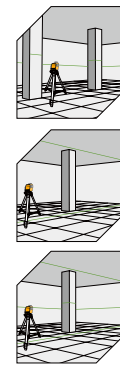
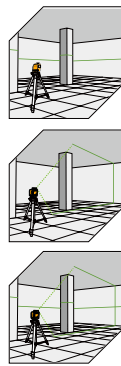
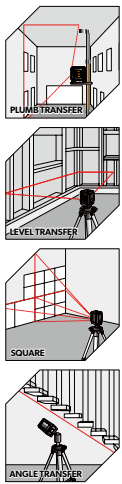

STOCK NO.	WAVELENGTH	MAX. WORKING DISTANCE	QTY./ CARTON
35141	Red 635nm	20m	12

GREEN-BEAM SELF-LEVELING 360° HORIZONTAL CROSS-LINE LASER LEVEL

- Green Beam Laser—more brighter than standard red beams
- One 360° Horizontal Plane and One Vertical Line—For a wide array of level and/or alignment applications
- Self-levels and indicates out-of-level condition; locks when switched off for secure laser transport
- Manual Mode—Locks lines for use at any angle
- Include a positioning device with strong magnets
- Laser unit: Osram
- Wavelength: 520nm
- Beam Accuracy: H/V Line $\pm 3\text{mm}/10\text{m}$
- Expanded Angle: C: 360° V: 130°
- Max. working distance: 30m(without detector)
- Power Supply: 4xAA battery(Not included)
- Operating time: C: 7.5h /V: 11.5h /C&V: 4.5h
- Ingression Protection Rate: IP54
- Operating Temperature: $-10^\circ\text{C} - +50^\circ\text{C}$
- Storage Temperature: $-20^\circ\text{C} - +70^\circ\text{C}$
- Pulse function
- Model Function: switchable manual model
- Packing: blow mould case

INDUSTRIAL



STOCK NO.	WAVELENGTH	MAX. WORKING DISTANCE	QTY./ CARTON
35153	Green 520nm	30m	6

GREEN-BEAM SELF-LEVELING TWO-PLANE LEVELING AND ALIGNMENT-LINE LASER

- Green Beam Laser—more brighter than standard red beams
- Two 360° Plane Horizontal and Vertical —For a wide array of level and vertical alignment applications
- Self-levels and indicates out-of-level condition; locks when switched off
- Manual Mode—Locks lines for use at any angle
- Includes Positioning Device with strong magnets
- Laser unit: Osram
- Wavelength: 520nm
- Beam Accuracy: H/V Line $\pm 3\text{mm}/10\text{m}$
- Expanded Angle: H&V 360°
- Max. working distance: 30m(without detector)
- Power Supply: 4xAA battery(Not included)
- Operating time: 1C: 8h /2C: 4h
- Ingression Protection Rate: IP54
- Operating Temperature: $-10^\circ\text{C} - +50^\circ\text{C}$
- Storage Temperature: $-20^\circ\text{C} - +70^\circ\text{C}$
- Pulse function
- Model Function: switchable manual model
- Packing: blow mould case

INDUSTRIAL



STOCK NO.	WAVELENGTH	MAX. WORKING DISTANCE	QTY./ CARTON
35154	Green 520nm	30m	6

INSTRUMENT TRIPOD

- Material: Aluminium
- Max. operation height: 1425mm/56"
- Closed height: 545mm
- Stretch range: 280mm
- Thread mount: 1/4"
- Weight: 1.1kgs
- Packing: canvas bag with color box

1425 mm
Max. height
56"

545 mm
Min. height
21.5"



STOCK NO.	SIZE	QTY./CARTON
35165	545-1425mm	10

EXTENSION POLE

- Four sections with maximum height of 3.85m (12-1/2ft)
- Sliding platform
- Thread mount: 1/4" & 5/8"
- Packing: canvas bag

3.85M
Max. height
12-1/2ft

1.23M
Min. height
4ft



STOCK NO.	SIZE	QTY./CARTON
35168	3.85m / 12-1/2ft	6

LASER DISTANCE METER

- Size: 120x48.5x28.5mm
- Functions: distance measurement, area measurement, volume measurement, pythagorean measurement, addition and subtraction calculation, continuous measurement, 20 groups of data storage
- Drop-resistance 1.5m
- Horizontal bubble
- Adjustable baseline switch
- Measuring units: m/ft/in
- Measuring accuracy: ±2.0mm
- Battery type: 2xAAA(1.5V)(Not included)
- Battery life: 5000 measurements
- Backlight
- Features: tiny size extremely easy to use soft rubber housing 1.8 inch screen (black-on-white)
- Packing: color box

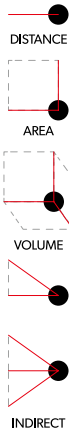

LASER DISTANCE METER

- Size: 100x32.5x22mm
- Functions: distance measurement, area measurement, volume measurement
- Drop-resistance 1.0m
- Measuring accuracy: ±2mm
- Battery type: 2xAAA(1.5V)(Not included)
- Measuring units: m/ft/in
- Battery life: 5000 measurements
- Backlight
- Features: tiny size extremely easy to use soft rubber housing perfect for DIY users
- Packing: color box



INDUSTRIAL



STOCK NO.	MEASURING RANGE	QTY./CARTON
35176	0.2-60m / 197ft	16



STOCK NO.	MEASURING RANGE	QTY./CARTON
35172	0.2-20m, 0.65-65.5ft	20

INFRARED THERMOMETER

- CE approval
- Temperature measurement range: -50°C~800°C (-58°F~1472°F)
- LCD color display screen with back light
- Response time<0.5S
- Laser:<1mW(630nm~650nm) 12 point
- Auto power off
- Low battery power indication
- Temperature upper / lower limit alarm
- Battery : 6F22 (9V) included
- Packing: color box



STOCK NO.	TEMPERATURE MEASUREMENT RANGE	QTY./CARTON
35196	-50°C~800°C (-58°F~1472°F)	10

MEASURING WHEEL

- Measuring range: 0-99999.9 m/ft
- Wheel Diameter:159 mm
- Circle Range:5000mm
- Accuracy: ±0.5%
- Display Resolution: 0.1m /0.3ft
- Large digital display screen, backlight system shows datas clearly and accurate
- Metric and feet reading with memory function
- Light weight, retractable aluminium handle, easy to carry.
- Expansion Length:1050mm Retracted Length:620mm
- Flexible and durable ABS wheel with TPR thick tire
- With starting point arrow and kickstand supports
- 2xAA batteries are included
- Packing: Rainproof carrying bag with color box



LARGE DIGITAL display screen BACKLIGHT SYSTEM
shows datas clearly and accurated accurate



METER FEET READING
with memory function

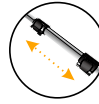

LIGHT WEIGHT, RETRACTABLE ALUMINIUM HANDLE
easy to carry



Flexible and durable **ABS WHEEL TPR THICK TIRE**



STARTING POINT ARROW
and kickstand supports

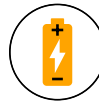

2xAAA
(included)



STOCK NO.	MEASURING RANGE	QTY./CARTON
35191	0-99999.9 m/ft	10

MEASURING WHEEL

- Measuring range: 0-99999.9 m/ft
- Wheel Diameter:318 mm /12.5inch
- Circle Range:10000mm
- Accuracy: ±0.5%
- Display Resolution: 0.1m /0.3ft
- Large digital display screen, backlight system shows datas clearly and accurate
- Metric and feet reading with memory function
- Light weight, retractable aluminium handle, easy to carry.
- Expansion Length:1000mm Retracted Length:660mm
- Flexible and durable ABS wheel with TPR thick tire
- With starting point arrow and kickstand supports
- 2xAA batteries are included
- Packing: Rainproof carrying bag with color box



LARGE DIGITAL display screen BACKLIGHT SYSTEM
shows datas clearly and accurated accurate



METER FEET READING
with memory function



LIGHT WEIGHT, RETRACTABLE ALUMINIUM HANDLE
easy to carry



Flexible and durable **ABS WHEEL TPR THICK TIRE**



STARTING POINT ARROW
and kickstand supports

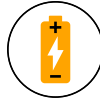

2xAAA
(included)



STOCK NO.	MEASURING RANGE	QTY./CARTON
35192	0-99999.9 m/ft	5

SPRING TABLE SCALE

- Stainless steel measuring bowl, Diameter 25cm
- Display: dial plate with KG/LB scale, red pointer for easy read
- Max. weight : 20kg / 44LB
- Graduation: 100g / 4oz
- Durable galvanized adjustable nut
- Thickened mask with stainless steel ring provides better firmness
- Packing: color box

**20kg/
44lb**
(100g/4oz)



STOCK NO.	SIZE	QTY./CARTON
35199	20kg/44lb(100g/4oz)	8

DIGITAL COMMERCIAL PRICE SCALE

- CE approval
- Charging voltage:220-240V 50/60Hz, Euro plug
- MAX.weight: 40KG/88LB
- With 2g/0.004lb graduation
- Display: double side LED screen for better reading
- Stainless iron table size:345x250mm
- lb/kg conversion button makes it easy for you to convert unit
- With a horizontal vacuole
- Built-in rechargeable battery/3xLR20 battery
- Sensitive response
- T-shaped scale table prevent things from rolling off
- Durable ABS body
- Packing: color box

**40kg/
88lb**
(2g/0.004lb)



**DOUBLE
SIDE LED**
screen for
better reading



Stainless iron
table size:
345x250mm



With a
horizontal
vacuole



STOCK NO.	SIZE	QTY./CARTON
35200	40kg/88lb (2g/0.004lb)	5

ELECTRONIC PLATFORM SCALE

- CE approval
- Charging voltage:220-240V 50/60Hz, Euro plug
- MAX.weight:
100KG/220LB(35201),300KG/660LB(35202)
With 20g / 0.04lb graduation(35201)
With 50g / 0.1lb graduation(35202)
- Display: LED screen for better reading
- Stainless iron table size:
300x400mm(35201), 400x500mm(35202)
- With built-in four high-precision load sensors for easy adjustment
- With 90-degree folding design, convenient for carry and storage.
- lb/kg conversion button makes it easy to convert unit
- Built-in rechargeable battery
- Packing: color box

**100kg/
220lb**
(20g/0.04lb)

**300kg/
660lb**
(50g/0.1lb)



STOCK NO.	SIZE	QTY./CARTON
35201	100kg/220lb (20g/0.04lb)	1
35202	300kg/660lb (50g/0.1lb)	1





ELECTRICAL TOOLS

VOLTAGE TESTER

- CE approved
- Neon bulb
- Test Voltage: AC 100-500V
- Packing: plastic hanger with color label



STOCK NO.	SIZE	QTY./CARTON
38114	3x140mm	480

VOLTAGE TESTER

- CE approved
- Neon bulb
- Test Voltage: AC 100-500V
- Packing: plastic hanger with color label



STOCK NO.	SIZE	QTY./CARTON
38115	4x190mm	480

DIGITAL VOLTAGE TESTER

- CE approval
- Test voltage: 12V - 250V AC
- Size: 3.5x130mm
- LCD display
- Rapid induction voltage testing
- Packing: double blister



STOCK NO.	SIZE	QTY./CARTON
38109	3.5x130mm	96

NON-CONTACT AC VOLTAGE DETECTOR

- CE approval
- Manufactured according to CAT III (1000V) standard
- AC voltage range: 12-1000V
- Frequency: 50-60Hz
- Alarm mode: Sound and light
- Flash light: white
- With auto power off function
- Probe shape: prolate
- With Low-battery indication
- NCV sensitivity: automatic selection of 3 kinds of sensitivity (high, medium and low)
- NCV sensitivity indication: 3 kinds of frequency, sound and LED alarmed
- Battery type: 2x1.5V AAA (Not included)
- Packing: double blister



3 KINDS OF SENSITIVITY
high, medium and low



STOCK NO.	QTY./CARTON
38110	60

VDE SCREWDRIVER

- CrV
- 1000V, VDE Certification
- Packing: PP hanger



STOCK NO.	SIZE	QTY./CARTON
38000	3.0x75mm	144
38001	4.0x100mm	144
38002	5.5x125mm	144
38003	6.5x150mm	72

VDE SCREWDRIVER

- CrV
- 1000V, VDE Certification
- Packing: PP hanger



STOCK NO.	SIZE	QTY./CARTON
38006	PH1x80mm	144
38007	PH2x100mm	72

VDE SCREWDRIVER

- CrV
- 1000V, VDE Certification
- Packing: PP hanger



STOCK NO.	SIZE	QTY./CARTON
38010	PZ1x80mm	144
38011	PZ2x100mm	72

5PCS VDE SCREWDRIVER SET

- CrV
- 1000V, VDE Certification
- Packing: blister card



STOCK NO.	SIZE	QTY./CARTON
38012	3x75, 4x100, 5.5x125; PH1x80, PH2x100	20

6PCS VDE SCREWDRIVER SET

- 1000V,VDE Certification
- Packing: color box

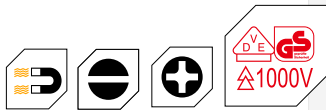

STOCK NO.	SIZE	QTY./CARTON
38013	3x75, 4x100, 5.5x100; PH1x80, PH2X100, 3x140mm	20

13PCS VDE INSULATED SCREWDRIVER SET

- VDE/GS certificated
- 4pcs Slotted: 1.2x6.5x100mm, 1x5.5x100mm, 0.8x4x100mmx0.5x3x100mm
- 2pcs Phillips: PH2x100mm, PH1x80mm
- 2pcs Pozidriv: PZ2x100mm, PZ1x80mm
- 3pcs Torx: T20x100mm, T15x100mm, T10x100mm
- 1Pc single-pole voltage tester
- 1Pc screwdriver handle
- Packing: color box



STOCK NO.	SIZE	QTY./CARTON
38016		12

HEAVY DUTY CABLE CUTTER

- Drop forged high quality tool steel
- Polished surface
- With PVC grip
- Packing: color label



STOCK NO.	SIZE	MAX. CUTTING CAPACITY	QTY./CARTON
38101	18"	Ø14mm / 150mm ²	10
38102	24"	Ø18mm / 250mm ²	8

CABLE CUTTER

- Drop forged high quality tool steel
- Dipped handle
- Packing: blister card



STOCK NO.	SIZE	MAX. CUTTING CAPACITY	QTY./CARTON
38020	160mm, 6"	Ø6mm / 25mm ²	60
38021	200mm, 8"	Ø7mm / 35mm ²	48

CABLE CUTTER

- Heavy duty
- Drop forged high quality tool steel
- Dipped handle
- Packing: blister card



STOCK NO.	SIZE	MAX. CUTTING CAPACITY	QTY./CARTON
38022	250mm, 10"	Ø9mm / 60mm ²	36

ELECTRICIAN'S KNIFE

- With straight head
- Special stainless steel
- Thickness: 3mm
- Fine polished wooden handle
- Packing: blister card



STOCK NO.	SIZE	QTY./CARTON
38040	205mm	72

ELECTRICIAN'S KNIFE

- With bend head
- Special stainless steel
- Thickness: 3mm
- Fine polished wooden handle
- Packing: blister card



STOCK NO.	SIZE	QTY./CARTON
38041	195mm	72

ELECTRICIAN'S SCISSORS

- Stainless steel blade
- Designed for telecom and electrical applications
- Packing: blister card

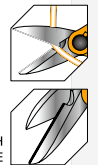

SERRATED TEETH GRIP THE CABLE/WIRE

STOCK NO.	SIZE	QTY./CARTON
30043	140mm, 5.5"	120

PVC INSULATING TAPE

- Pure PVC
- CE approved
- Packing: color paper



STOCK NO.	SIZE	THICKNESS	LENGTH	QTY./CARTON
38023	19mm (black)	0.13mm	10yards (9.15m)	400
38024	19mm (white)	0.13mm	10yards (9.15m)	400
38025	19mm (red)	0.13mm	10yards (9.15m)	400

ADJUSTABLE AUTOMATIC WIRE STRIPPER

- 2-IN-1 Wire stripper & cutter
- Applicable wire stripper size: 0.5mm² - 6mm²
- Self-adjustable mechanism according to wire size provide excellent wire stripping
- Adjustable stop for consistency in wire strip lengths, replaceable blade system
- Strip 8mm width flat cable also applicable
- Simple adjustment dial for blade pressure according to the thickness of insulation
- Packing: blister card



STOCK NO.	SIZE	QTY./CARTON
38050	0.5-6mm ²	48

AUTOMATIC WIRE STRIPPER

- Applicable wire diameter: 1.0, 1.6, 2.0, 2.6, 3.2mm (18-8AWG)
- Packing: blister card



STOCK NO.	SIZE	QTY./CARTON
38049		48

WIRE STRIPPERS

- 7-in-1 stripping function 0.6-2.6mm, 22-10 AWG
- With grip and cutter
- Packing: blister card



STOCK NO.	SIZE	QTY./CARTON
38051	160mm, 6"	72

WIRE STRIPPING AND CRIMPING PLIERS

- With sharp edge for cutting wire
- With push down wire function
- With wire stripping function
- Can strip six kinds of wire size
- Can cut five kinds of copper screw size
- Packing: blister card



STOCK NO.	SIZE	QTY./CARTON
38052	215mm, 8.5"	72

RATCHET MODULAR CRIMPING PLIERS

- Special tool steel with hardened and tempered frame
- Chemically black finished surface
- PP/TPR Two-component grips
- Compact and durable W/KEY way in 8P modular holder
- Cut and strip wire by one operation, easy and efficient
- With round cable stripper
- For crimping modular plug as follows: 8P8C/RJ45, 8P6C, 8P4C, 8P2C; 6P6C/RJ12, 6P4C/RJ11, 6P2C
- Packing: blister card



wire cutting



wire stripping



labor-saving ratchet handle

STOCK NO.	SIZE	QTY./CARTON
38054	185mm, 7.3" 8P/6P	50

AUTO WIRE STRIPPER

- Zink alloy head
- Cr12MoV, HRC52-60°
- Black finished surface
- Two-component plastic handle
- Stripping Gauge: 24-10AWG / 0.2-6mm²
- Cutting/Crimping: 22-10AWG / 0.5-6mm²
- Non insulated Terminal: 12-10AWG / 4-6mm²
- Non insulated Terminal: 16-14AWG / 1.5-2.5mm²
- Non insulated Terminal: 22-18AWG / 0.5-1mm²
- Packing: double blister

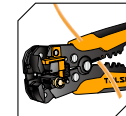

wire cutting



wire stripping



wire crimping



STOCK NO.	SIZE	QTY./CARTON
38048	200mm, 8"	40

RATCHET CRIMPING PLIERS

- Special tool steel with hardened and tempered jaws
- Continuous crimping at preset tension ensures accurate crimp
- Chemically black finished surface
- PVC grips
- Suitable for crimping insulated terminals as follows: DIN 0.5-1.0 / 1.5-2.5 / 4-6 mm² AWG 22-18 / 16-14 / 12-10
- Packing: blister card

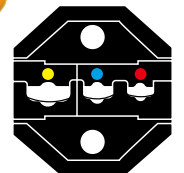

STOCK NO.	SIZE	QTY./CARTON
38056	220mm, 8.7" DIN 0.5-6mm ²	30

MULTI-FUNCTION STRIPPING COMBINATION PLIERS

- Made of 60CR-V, forged
- Black finished and polished surface
- Comfortable Grip
- Wire Stripper and Crimper Capacity - Strips 10-18 AWG solid and 12-20 AWG stranded wire
- Wire terminal crimping from 0.5 to 2.5mm²
- Crosscut Teeth - Help multiple wires stay in position while twisting.
- Hardened teeth can also be used as smoothing and shaping files
- Size: 8.5" / 215mm
- Packing: blister card

NEW

60 CRV



32% LABOR SAVING

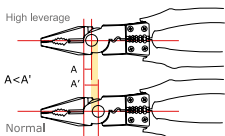

STOCK NO.	SIZE	QTY./CARTON
10294	215mm, 8.5"	36

INDUSTRIAL

GLUE GUN

- Rated voltage: 220-240V~50Hz
- Input power: 15w
- 2pcs glue sticker included
- Packing: double blister
- Approved by GS



STOCK NO.	QTY./CARTON
79105	40

GLUE GUN

- CE approval
- Input power: 20W
- Rated Voltage: 220-240V
- Frequency: 50Hz
- Gluing capacity: 8-10g/min
- Glue stick diameter: 7.0-7.5mm
- With over current protection
- High efficient PTC saves 50% power
- 3 mins fast pre-heating
- Anti-leakage design
- Ideal for adhesive attachment, model making, repairing, sealing and jointing
- Mechanical feed system for sensitive metering and rapid application
- Packing: double blister



STOCK NO.	QTY./CARTON
38070	48

GLUE GUN

- CE approval
- Input power: 60W
- Rated Voltage: 220-240V
- Frequency: 50Hz
- Gluing capacity: 15-20g/min
- Glue stick diameter: 11.2mm
- With over current protection
- High efficient PTC saves 50% power
- 3 mins fast pre-heating
- Anti-leakage design
- Ideal for adhesive attachment, model making, repairing, sealing and jointing
- Mechanical feed system for sensitive metering and rapid application
- Packing: double blister



STOCK NO.	QTY./CARTON
38071	30

12PCS HOT MELT GLUE STICK SET

- Suitable for TOLSEN 38070 / 38500
- Packing: blister card



STOCK NO.	SIZE	QTY./CARTON
38078	7x100mm	120

12PCS HOT MELT GLUE STICK SET

- Suitable for TOLSEN 79105, 38501, 38502, 38071
- For general use
- Packing: blister card



STOCK NO.	SIZE	QTY./CARTON
79110	11.2x100mm	120

HOT MELT GLUE STICK SET

- Weight: 1kg
- Suitable for TOLSEN 79105, 38501, 38502, 38071
- Packing: color box



STOCK NO.	SIZE	QTY./CARTON
79111	11.2x200mm	16

SOLDERING IRON

- GS/CE approved
- Voltage: 230V~50/60Hz
- Preheat time: 3~5minuters
- Straight, Tip head
- With a piece of support
- Great for electronics, computer equipment, watch repair and many other hobby and craft projects
- Packing: blister card

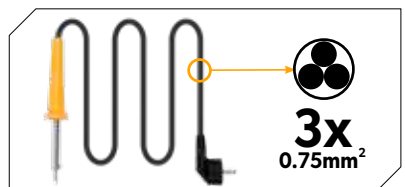

STOCK NO.	INPUT POWER	QTY./CARTON
38060	30W	36
38062	60W	36
38064	100W	36

INDUSTRIAL

DIGITAL MULTIMETER

- CE approval
- 1999 counts
- DC Voltage: 200m/2/20/200/600V
- DC Current: 200μ/2m/20m/250m/10A
- AC Voltage: 200/600V
- Resistance: 200/2k/20k/200k/2MΩ
- LCD color display screen with back light
- Overload protection
- Battery : 6F22 (9V) included
- Packing: color box

INDUSTRIAL



STOCK NO.	QTY./CARTON
38030	40

DIGITAL MULTIMETER

- IEC-61010 CAT III 300V
- 3 1/2 digits LCD, Maximum display 1999
- Large LCD display
- Low Battery indication
- Overload protection
- Data-hold mode
- Auto power off
- Specifications
- **DC Voltage:** 200m/2/20/200/300V
- **AC Voltage:** 2/20/200/300V
- **DC Current:** 200μ/2m/20m/200m/10A
- **AC Current:** 2m/20m/200m/10A
- **Resistance:** 200/2k/20k/200k/2M/20MΩ
- **Battery Check:** 1.5V,9V included
- **Diode Check**
- Battery : 6F22 (9V) included
- Test lead: plug black & red
- CE approved
- Packing: color box

INDUSTRIAL



STOCK NO.	QTY./CARTON
38031	20

DIGITAL MULTIMETER

- CE approval
- 6000 counts
- DC Voltage: 60mV/6/60/600/1000V
- DC Current: 60μ/6/60/600mA/10A
- AC Voltage: 6/60/600/750V
- AC Current: 60m/600m/10A
- Resistance: 600/6k/60k/600k/6M/60MΩ
- Capacitance: 60nf/600nf/6/60/600uf/6/60mf
- Frequency 60~ 1000Hz
- Non-contact voltage detection live line or neutral Line distinguish
- LCD color display screen with back light
- Overload protection
- Low battery power indication
- Data hold
- NCV function
- Auto power off
- Flash light function
- Batteries : 4xAA (1.5V) included
- Packing: color box

INDUSTRIAL



STOCK NO.	QTY./CARTON
38033	30

DIGITAL CLAMP MULTIMETER

- IEC-61010 CATII 600V/CATIII 300V
- 3 1/2 digits LCD, Maximum display 1999
- Maximum opening size :28mm
- Low Battery Indication
- Overload protection
- Data-hold model
- Auto power off
- Specifications
- AC Current:**
400A±(1.5% +9)
- AC Voltage:**
600V±(1.2% +5)
- DC Voltage:**
600V±(0.8% +1)
- Resistance:**
20MΩ±(1.0% +2)
- Diode Check**
- Batteries : 2xAAA (1.5V) included
- Test lead: plug black & red
- CE approved
- Packing: color box

INDUSTRIAL



STOCK NO.	SIZE	QTY./CARTON
38034	210x75.6x30mm	20

AC DIGITAL CLAMP METER

- CE approval
- 6000 counts
- DC Voltage: 6/60/600/1000V
- DC Current: 60/600/1000A
- AC Voltage: 6/60/600/1000V
- Resistance: 6k/60k/600k/6M/60MΩ
- Capacitance: 60nf/600nf/6/60/600uf/6/60mf
- Frequency 60~1000Hz
- Temperature: -20-1000°C
- LCD color display screen with back light
- Overload protection
- Low battery power indication
- Data hold
- NCV function
- Auto power off
- Flash light function
- Batteries : 3xAAA (1.5V) included
- Packing: color box

INDUSTRIAL



STOCK NO.	SIZE	QTY./CARTON
38035	210x75.6x30mm	20

LED FLASHLIGHT

- Led Flashlight, 1watt CREE
- Main material: aluminium
- Battery Voltage: 1.5V
- Battery type: 1xAAA Battery (NOT included)
- Brightness: 50 Lumens
- Range: 50M
- Working time: 1.5 Hours
- Product N.W: 36g
- Waterproof: IP66
- Packing: double blister

INDUSTRIAL



STOCK NO.	SIZE	QTY./CARTON
60031	Ø20x97.5mm	60

LED FLASHLIGHT WITH ZOOM FUNCTION

- Led Flashlight, 3 watt CREE
- Main material: aluminium
- Battery Voltage: 4.5V
- Battery type: 3xAAA Batteries (NOT included)
- Brightness: 150 Lumens
- Range: 120M
- Working time: 5 Hours
- Product N.W: 95g
- Waterproof: IP65
- Packing: double blister

INDUSTRIAL



STOCK NO.	SIZE	QTY./CARTON
60033	Ø34x110mm	36

LED FLASHLIGHT WITH ZOOM FUNCTION

- Led Flashlight, 10 watt CREE
- Main material: aluminium
- Battery Voltage: 4.5V
- Battery type: 3xC Batteries (NOT included)
- Brightness: 550 Lumens
- Range: 300M
- Working time: 8 Hours
- Product N.W: 200g
- Waterproof: IP65
- Packing: double blister

INDUSTRIAL



STOCK NO.	SIZE	QTY./CARTON
60035	Ø38.5x212mm	24

7 WHITE LED HEAD LIGHT

- Main material: ABS
- Multi-function: 1LED-3LED-7LED
- Brightness: 50 Lumens
- Battery type: 3xAAA Batteries (NOT included)
- Packing: double blister



STOCK NO.	QTY./CARTON
60011	60

LED FLASHLIGHT

- Material: PP+PVC
- Battery Voltage: 3V
- Battery type: 2xAA Batteries (NOT included)
- LED source: 3 LED
- Brightness: 12 Lumens
- Range: 10M
- Working time: 16 Hours
- Product N.W: 65g
- Waterproof: IP62
- Packing: PP card



STOCK NO.	SIZE	QTY./CARTON
60020	Ø40x148mm	60

LED FLASHLIGHT

- Material: PP+PVC
- Battery Voltage: 3V
- Battery type: 2xD Batteries (NOT included)
- LED source: 7 LED
- Brightness: 30 Lumens
- Range: 15M
- Working time: 30 Hours
- Product N.W: 220 g
- Waterproof: IP62
- Packing: PP card



STOCK NO.	SIZE	QTY./CARTON
60021	Ø70x208mm	48

LED WORKING LIGHT

- Material: ABS
- Battery Voltage: 4.5V
- Battery type: 3xAA Batteries (NOT included)
- LED source: 24 LED
- Brightness: 40 Lumens
- Range: 15M
- Working time: 10 Hours
- Product N.W: 120g
- Waterproof: IP62
- Packing: display box



STOCK NO.	SIZE	QTY./CARTON
60015	210x58x30mm	48

WORK LIGHT

- CE approval
- Battery: 1pc Li-ion rechargeable battery (3.7V/2000mAh)
- Brightness: 300 lumens (Max) 100 lumens (Min)
- High light 2.5H runtime
- Low light 6H runtime
- With USB charger
- Adjustable bracket
- With strong magnets at back and bottom side
- Size: 280x56x35mm
- Net weight: 250g
- Packing: double blister

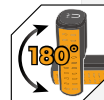

STOCK NO.	SIZE	QTY./CARTON
60018	280x56x35mm	10

WORKING LAMP

- CE approval
- 10W COB LED
- Battery: 2pcs Li-ion batteries, 3.7V 4400mAh
- Function: Low - High - Off
- Max output: 1100 Lumens in High mode; 350 Lumens in Low mode
- Working time: 3 Hrs in high mode; 6 Hrs in low mode
- Charging time: 6 Hrs
- With USB charge cable, fits power adapter: 5V / 1A
- Swivel stand base can rotate 180°
- Durable aluminium housing with rubber coated supply a comfy grip
- Power bank function can charge for mobile phones for emergency
- Power display function: Intelligently detect the charging status and the remaining power
- Waterproof: IP65
- Packing: double blister

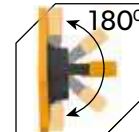

STOCK NO.	SIZE	QTY./CARTON
60055	10W	10

WORK LIGHT

- CE approval
- Dimension: 30 x 21 x 152mm
- High strength anti-skid ABS material
- Front: 2W COB LED
- Top: 1W LP SMD LED
- Battery: 1pc Li-ion battery, 3.7V 750mAh
- Function: COB Low - COB High - SMD ON - Off
- Max output: 110 Lumens in COB High mode; 30 Lumens in COB Low mode; 60 Lumens in SMD mode
- Working time: 2 Hrs in COB high mode; 6.5 Hrs in COB low mode; 3.5 Hrs in SMD mode;
- Charging time: 2Hrs
- With USB charge cable
- Adjustable bracket
- Packing: double blister

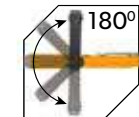

STOCK NO.	SIZE	QTY./CARTON
60016	2W+1W	24

T5 LED TUBE LAMP

- CE approved
- 230V, 50HZ, 14W
- With 84pcs SMD
- Brightness: 1300 Lumens
- Color temperature: 5000K
- VDE wire line: 1.83m, 2x0.75mm²
- VDE EU PLUG
- Packing: white box



STOCK NO.	SIZE	QTY./CARTON
83013	905x22x31mm	20

WORKING LAMP

- CE approval
- Input power: 50W
- Rated Voltage: 220-240V
- Frequency: 50-60HZ
- Lamp base: E27
- Zinc plated hook and reflector
- Packing: plastic bag with paper hanger



STOCK NO.	SIZE	PLUG & CABLE	QTY./CARTON
60050	Max. 60W	5m	15
60051	Max. 60W	10m	15

LED LIGHT BULB

- Input voltage: 220-240V~50/60Hz
- CCT: 6500K
- Base: E27
- PF: ≥ 0.5
- CRI: ≥ 80
- Beam angle: 220°
- Average life: ≥ 15000h
- Material: Heat sinking part aluminium
- Packing: color box

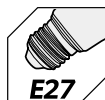

Day Light

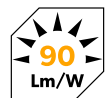

PLASTIC & ALUMINIUM

STOCK NO.	POWER	LUMINOUS	DIMENSION	QTY./CARTON
60201	5W	450Lm	Ø55x100mm	100
60202	7W	630Lm	Ø60x107mm	100
60203	9W	810Lm	Ø60x107mm	100
60204	12W	1080Lm	Ø65x127mm	50
60205	15W	1350Lm	Ø70x134mm	50
60206	18W	1620Lm	Ø80x154mm	50

LED



LED T LAMP

- Input voltage: 220-240V~50/60Hz
- CCT: 6500K
- Base: E27
- PF: ≥ 0.5
- CRI: ≥ 80
- Beam angle: 220°
- Average life: ≥ 15000h
- Material: Heat sinking part aluminum
- Packing: color box

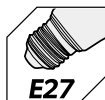

Day Light

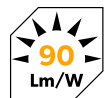

PLASTIC & ALUMINIUM

STOCK NO.	POWER	LUMINOUS	DIMENSION	QTY./CARTON
60211	20W	1800Lm	Ø80x143mm	20
60212	30W	2700Lm	Ø100x166mm	12
60213	40W	3600Lm	Ø118x202mm	12
60214	50W	4500Lm	Ø138x227mm	12

LED



TOLSEN VDELIN^E



VDE refers to Verband Deutscher Elektrotechniker in German. Technical working equipment and consumable materials subject to the applicable device and product safety laws bear the VDE-GS mark, which stands for the safety of the product with regard to electrical, mechanical, thermal, toxicological, radiological and other dangers. In addition, tools with the VDE-GS mark conform to the VDE regulations or European or internationally harmonised standards, i.e. they confirm the compliance with the safety requirements of the respective guidelines.

INSULATED TOOLS

PREMIUM
top quality for professionals

 1000V

DOUBLE TRIANGLE AND VOLTAGE RANGE

If insulated tools or aids are marked with the symbol of the double triangle and the assigned voltage or voltage range specification or the class, they are suitable for working on energised parts at the stated voltage.

DIN EN 60900 (IEC 60900)

An international standard which, among other things, describes the design of insulated tools in detail. For example, the thickness of the protective insulation is specified. In addition, the standard defines individual tests (piece tests) as well as series and random sample tests for checking the electrical safety of the protective insulation.



INSULATION TESTS

Every tool is tested to 10,000V



IMPACT TEST

The first test is carried out at ambient temperature of $23 \pm 5^\circ\text{C}$ and the energy of impact test can be equal to a fall from a height of 2 meters.

The second test is carried out at an ambient temperature of $-25 \pm 3^\circ\text{C}$ and the energy of impact test can be equal to a fall from a height of 0.6 meters. If with C marked, the test need to be done by $-40 \pm 3^\circ\text{C}$.



ELECTRICAL TEST

The test piece is immersed in a bath of water at room temperature of 24 ± 0.5 hours. there should be no electrical discharge, spark over or flashover during 3mins testing at a voltage of 10KV.



INDENTATION TEST

With loading a weight of 20N and a voltage of 5KV, the indenter is applied to the centre of handle. under the situation, the testing piece should pass the electrical test.



TEST FOR ADHESION OF THE INSULATING MATERIAL COATING

The test piece is heated to $70 \pm 3^\circ\text{C}$ for 168 hours, then loaded with weights. the handle should fully attached to the metal part aer 3mins testing.



FLAME RETARDANCY TEST

The flame is applied to the test piece for 10 seconds. the height of the flame on the burning handle should not exceed 120mm in 20 seconds after burner removed.

INSULATED COMBINATION PLIERS

- VDE/GS certificated
- Manufactured according to EN60900
- Metal part made in CrV steel
- Black finished and polished surface
- Precision machined body with strictly heat treatment
- Heavy two-component insulated handles with slip guards for extra comfort and safety
- Packing: blister card



STOCK NO.	SIZE	QTY./CARTON
V16006	160mm,6"	36
V16007	180mm,7"	36
V16008	200mm,8"	36

INSULATED DIAGONAL CUTTING PLIERS

- VDE/GS certificated
- Manufactured according to EN60900
- Metal part made in CrV steel
- Black finished and polished surface
- Precision machined body with strictly heat treatment
- High leverage eccentric joint which makes the cutting of wires and cables up to 35% easier on the user
- Heavy two-component insulated handles with slip guards for extra comfort and safety
- Packing: blister card



STOCK NO.	SIZE	QTY./CARTON
V16036	160mm,6"	36

INSULATED DIAGONAL CUTTING PLIERS

- VDE/GS certificated
- Manufactured according to EN60900
- Metal part made in CrV steel
- Black finished and polished surface
- Precision machined body with strictly heat treatment
- High leverage eccentric joint which makes the cutting of wires and cables up to 35% easier on the user
- Heavy two-component insulated handles with slip guards for extra comfort and safety
- Packing: blister card



STOCK NO.	SIZE	QTY./CARTON
V16037	180mm,7"	36

INSULATED LONG NOSE PLIERS

- VDE/GS certificated
- Manufactured according to EN60900
- Metal part made in CrV steel
- Black finished and polished surface
- Precision machined body with strictly heat treatment
- Flat-round jaws have serrated gripping surfaces
- Heavy two-component insulated handles with slip guards for extra comfort and safety
- Packing: blister card



STOCK NO.	SIZE	QTY./CARTON
V16096	160mm,6"	36
V16098	200mm,8"	36

INSULATED BENT NOSE PLIERS

- VDE/GS certificated
- Manufactured according to EN60900
- Metal part made in CrV steel
- Black finished and polished surface
- Precision machined body with strictly heat treatment
- Heavy two-component insulated handles with slip guards for extra comfort and safety
- Packing: blister card



STOCK NO.	SIZE	QTY./CARTON
V16026	160mm,6"	36
V16028	200mm,8"	36

INSULATED FLAT NOSE PLIERS

- VDE/GS certificated
- Manufactured according to EN60900
- Metal part made in CrV steel
- Black finished and polished surface
- Precision machined body with strictly heat treatment
- Flat jaws have serrated gripping surfaces
- Heavy two-component insulated handles with slip guards for extra comfort and safety
- Packing: blister card



STOCK NO.	SIZE	QTY./CARTON
V16046	160mm,6"	36

PREMIUM

PREMIUM

PREMIUM

PREMIUM

PREMIUM

PREMIUM

INSULATED ROUND NOSE PLIERS

- VDE/GS certificated
- Manufactured according to EN60900
- Metal part made in CrV steel
- Black finished and polished surface
- Precision machined body with strictly heat treatment
- Heavy two-component insulated handles with slip guards for extra comfort and safety
- Packing: blister card



STOCK NO.	SIZE	QTY./CARTON
V16056	160mm,6"	36

INSULATED WIRE STRIPPING PLIERS

- VDE/GS certificated
- Manufactured according to EN60900
- Metal part made in CrV steel
- Black finished and polished surface
- Precision machined body with strictly heat treatment
- Smoothly ground accurate V shaped polished jaw head with locking adjustable screw for setting to the desired diameter.
- Can be used for solid or stranded wire up to 5mm (10mm²) diameter.
- Heavy two-component insulated handles with slip guards for extra comfort and safety
- Packing: blister card



STOCK NO.	SIZE	QTY./CARTON
V16066	160mm,6"	36



Check that the insulation is not damaged each time before using the tool; defective tools must not be used and should be stripped of all insulation.



Keep your 1000V VDE tools clean and dry.

7PCS INJECTION INSULATED SET

- 1pc 200mm insulated combination pliers
- 1pc 160mm insulated long nose pliers
- 1pc 160mm insulated diagonal cutting pliers
- 4pcs insulated slotted screwdriver: PH1x80mm, PH2x100mm, 0.5x3x100mm, 0.8x4x100mm
- VDE/GS certificated
- Manufactured according to EN60900
- Precision machined body with strictly heat treatment
- Heavy two-component insulated handles with slip guards for extra comfort and safety
- Packing: canvas bag with color box



STOCK NO.	QTY./CARTON
V80107	10

3PCS INSULATED PLIERS SET

- 1pc 180mm insulated combination pliers
- 1pc 160mm insulated long nose pliers
- 1pc 160mm insulated diagonal cutting pliers
- VDE/GS certificated
- Manufactured according to EN60900
- Metal part made in CrV steel
- Black finished and polished surface
- Precision machined body with strictly heat treatment
- Heavy two-component insulated handles with slip guards for extra comfort and safety
- Packing: canvas bag with color box



STOCK NO.	QTY./CARTON
V83103	10

4PCS INSULATED PLIERS SET

- 1pc 180mm insulated combination pliers
- 1pc 200mm insulated long nose pliers
- 1pc 160mm insulated diagonal cutting pliers
- 1pc 160mm insulated wire stripping pliers
- VDE/GS certificated
- Manufactured according to EN60900
- Metal part made in CrV steel
- Black finished and polished surface
- Precision machined body with strictly heat treatment
- Heavy two-component insulated handles with slip guards for extra comfort and safety
- Packing: canvas bag with color box



STOCK NO.	QTY./CARTON
V83204	10

6PCS INSULATED HAND TOOLS SET

- 1pc 180mm insulated combination pliers
- 1pc 160mm insulated diagonal cutting pliers
- 2pcs insulated slotted screwdriver: 0.4x2.5x75mm, 0.8x4.0x100mm
- 1pc insulated phillips screwdriver: PH2x100mm
- 1pc 3.0x70mm voltage tester
- VDE/GS certificated
- Manufactured according to EN60900
- Packing: canvas bag with color box



STOCK NO.	QTY./CARTON
V83306	10

11PCS INSULATED HAND TOOLS SET

- 1pc 180mm insulated combination pliers
- 1pc 200mm insulated long nose pliers
- 1pc 160mm insulated diagonal cutting pliers
- 1pc 160mm insulated wire stripping pliers
- 3pcs insulated slotted screwdriver: 0.4x2.5x75mm, 0.8x4.0x100mm, 1.0x5.5x125mm
- 2pcs insulated phillips screwdriver: PH1x80mm, PH2x100mm
- 1pc 3.0x70mm voltage tester
- 1pc 50x180mm cable knife
- VDE/GS certificated
- Manufactured according to EN60900
- Packing: canvas bag with color box



STOCK NO.	QTY./CARTON
V83411	6

14PCS INSULATED HAND TOOLS SET

- 1pc 160mm insulated combination pliers
- 1pc 160mm insulated long nose pliers
- 1pc 160mm insulated diagonal cutting pliers
- 1pc 160mm insulated wire stripping pliers
- 4pcs insulated slotted screwdriver: 0.6x3.5x100mm, 0.8x4.0x100mm, 1.0x5.5x125mm, 1.2x6.5x150mm
- 3pcs insulated phillips screwdriver: PH1x80mm, PH2x100mm, PH0x60mm
- 1pc 3.0x70mm voltage tester
- 1pc black insulated pvc tape
- 1pc red insulated pvc tape
- VDE/GS certificated
- Manufactured according to EN60900
- Packing: canvas bag with color box



STOCK NO.	QTY./CARTON
V80114	6

INSULATED SLOTTED SCREWDRIVER

- VDE/GS certificated
- S2 material blade, entirely hardened and tempered
- Chemically blacked surface
- Grip and sleeve manufactured according to EN60900
- Ergonomic shape for easy to handle
- With hanging hole
- Packing: plastic bag

PREMIUM



STOCK NO.	SIZE	QTY./CARTON
V30204	0.4x2.5x75mm	72
V30205	0.5x3.0x100mm	72
V30206	0.6x3.5x100mm	72
V30208	0.8x4.0x100mm	72
V30210	1.0x5.5x125mm	72
V30212	1.2x6.5x150mm	72

INSULATED PHILLIPS SCREWDRIVER

- VDE/GS certificated
- S2 material blade, entirely hardened and tempered
- Chemically blacked surface
- Grip and sleeve manufactured according to EN60900
- Ergonomic shape for easy to handle
- With hanging hole
- Packing: plastic bag

PREMIUM

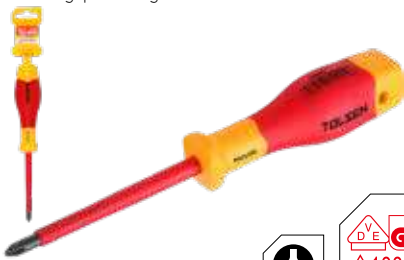

STOCK NO.	SIZE	QTY./CARTON
V30400	PH0x60mm	72
V30401	PH1x80mm	72
V30402	PH2x100mm	72
V30403	PH3x150mm	48

INSULATED POZI SCREWDRIVER

- VDE/GS certificated
- S2 material blade, entirely hardened and tempered
- Chemically blacked surface
- Grip and sleeve manufactured according to EN60900
- Ergonomic shape for easy to handle
- With hanging hole
- Packing: plastic bag

PREMIUM



STOCK NO.	SIZE	QTY./CARTON
V30600	PZ0x60mm	72
V30601	PZ1x80mm	72
V30602	PZ2x100mm	72
V30603	PZ3x150mm	48

INSULATED TORX SCREWDRIVER

- VDE/GS certificated
- S2 material blade, entirely hardened and tempered
- Chemically blacked surface
- Grip and sleeve manufactured according to EN60900
- Ergonomic shape for easy to handle
- With hanging hole
- Packing: plastic bag

PREMIUM



STOCK NO.	SIZE	QTY./CARTON
V30810	T10x70mm	72
V30815	T15x80mm	72
V30820	T20x100mm	72
V30825	T25x125mm	72
V30830	T30x130mm	72

INSULATED HEX SCREWDRIVER

- VDE/GS certificated
- S2 material blade, entirely hardened and tempered
- Chemically blacked surface
- Grip and sleeve manufactured according to EN60900
- Ergonomic shape for easy to handle
- With hanging hole
- Packing: plastic bag

PREMIUM



STOCK NO.	SIZE	QTY./CARTON
V31025	H2.5x75mm	72
V31003	H3.0x75mm	72
V31004	H4.0x75mm	72
V31005	H5.0x75mm	72
V31006	H6.0x100mm	72
V31008	H8.0x100mm	48

INSULATED NUT SCREWDRIVER

- VDE/GS certificated
- Chrome vanadium socket, entirely hardened and tempered
- Chemically blacked surface
- Grip and sleeve manufactured according to EN60900
- Ergonomic shape for easy to handle
- With hanging hole
- Packing: plastic bag

PREMIUM



STOCK NO.	SIZE	QTY./CARTON
V31204	4.0x125mm	72
V31205	5.0x125mm	72
V31255	5.5x125mm	72
V31206	6.0x125mm	72
V31207	7.0x125mm	72
V31208	8.0x125mm	72
V31209	9.0x125mm	72
V31210	10x125mm	72
V31211	11x125mm	48
V31212	12x125mm	48
V31213	13x125mm	48
V31214	14x125mm	48

8PCS INSULATED SCREWDRIVERS SET

- 4pcs insulated slotted screwdrivers: 0.4x2.5x75mm, 0.8x4.0x100mm, 1.0x5.5x125mm, 1.2x6.5x150mm
- 3pcs insulated phillips screwdrivers: PH0x60mm, PH1x80mm, PH2x100mm
- 1pc 3.0x70mm voltage tester
- VDE/GS certificated
- Manufactured according to EN60900
- Packing: color box

PREMIUM



STOCK NO.	QTY./CARTON
V32408	12

6PCS INSULATED SCREWDRIVERS SET

- 3pcs insulated slotted screwdrivers: 0.4x2.5x75mm, 0.8x4.0x100mm, 1.0x5.5x125mm
- 2pcs insulated phillips screwdrivers: PH1x80mm, PH2x100mm
- 1pc 3.0x70mm voltage tester
- VDE/GS certificated
- Manufactured according to EN60900
- Packing: color box

PREMIUM



STOCK NO.	QTY./CARTON
V33506	12



the colored endcap for easy selection

Each insulated tube and whole grip has passed 2 times 10,000V test to ensure safety, obtained VDE/GS certificate.

INSULATED PRECISION SLOTTED SCREWDRIVER

- VDE/GS certificated
- S2 material blade, entirely hardened and tempered
- Chemically blacked surface
- Grip and sleeve manufactured according to EN60900
- Ergonomic shape handle
- Packing: blister card



STOCK NO.	SIZE	QTY./CARTON
V31415	1.5x0.23x50mm	72
V31418	1.8x0.30x50mm	72
V31420	2.0x0.40x50mm	72
V31425	2.5x0.40x50mm	72
V31430	3.0x0.50x50mm	72

INSULATED PRECISION PHILLIPS SCREWDRIVER

- VDE/GS certificated
- S2 material blade, entirely hardened and tempered
- Chemically blacked surface
- Grip and sleeve manufactured according to EN60900
- Ergonomic shape handle
- Packing: blister card

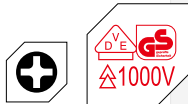

STOCK NO.	SIZE	QTY./CARTON
V31600	PH00x50mm	72
V31601	PH0x50mm	72
V31602	PH1x50mm	72

INSULATED PRECISION TORX SCREWDRIVER

- VDE/GS certificated
- S2 material blade, entirely hardened and tempered
- Chemically blacked surface
- Grip and sleeve manufactured according to EN60900
- Ergonomic shape handle
- Packing: blister card



STOCK NO.	SIZE	QTY./CARTON
V31806	T6x50mm	72
V31808	T8x50mm	72
V31810	T10x50mm	72
V31815	T15x50mm	72
V31820	T20x50mm	72

7PCS INSULATED PRECISION SCREWDRIVER SET

- 5pcs insulated precision slotted screwdrivers: 1.5x0.23x50mm, 1.8x0.30x50mm, 2.0x0.40x50mm, 2.5x0.40x50mm, 3.0x0.50x50mm
- 2pcs insulated precision phillips screwdrivers: PH00x50mm, PH0x50mm;
- VDE/GS certificated
- S2 material blade, entirely hardened and tempered
- Chemically blacked surface
- Grip and sleeve manufactured according to EN60900
- Ergonomic shape handle
- Packing: color box



STOCK NO.	QTY./CARTON
V32007	20

12PCS INSULATED CHANGEABLE SCREWDRIVER SET

- 1pc 31x105mm insulated ergonomic shape handle
- 7pcs insulated slotted screwdrivers: 0.4x2.0x100mm, 0.4x2.5x100mm, 0.5x3.0x100mm, 0.6x3.5x100mm, 0.8x4.0x100mm, 1.0x5.5x100mm, 1.2x6.5x100mm
- 3pcs insulated phillips screwdrivers: PH0x100mm, PH1x100mm, PH2x100mm
- 1pc 3.0x70mm voltage tester
- VDE/GS certificated
- Manufactured according to EN60900
- Packing: canvas bag with color box



STOCK NO.	QTY./CARTON
V33212	12

VOLTAGE TESTER

- CE certificated
- Test voltage: AC 125 ~ 250 V
- Packing: blister card



STOCK NO.	SIZE	QTY./CARTON
V70670	3.0x70mm	72

INSULATED OPEN END SPANNER

- VDE/GS certificated
- Manufactured according to EN60900
- Chrome vanadium material body, entirely hardened and tempered
- Handle are dipped with double layers
- Packing: plastic bag with paper hanger

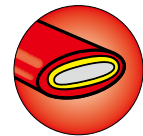

STOCK NO.	SIZE	QTY./CARTON
V40106	6mm	48
V40107	7mm	48
V40108	8mm	48
V40109	9mm	48
V40110	10mm	48
V40111	11mm	48
V40112	12mm	48
V40113	13mm	48
V40114	14mm	48
V40115	15mm	48
V40116	16mm	48
V40117	17mm	48
V40118	18mm	48
V40119	19mm	48
V40121	21mm	36
V40122	22mm	36
V40124	24mm	30
V40127	27mm	30
V40130	30mm	18
V40132	32mm	16

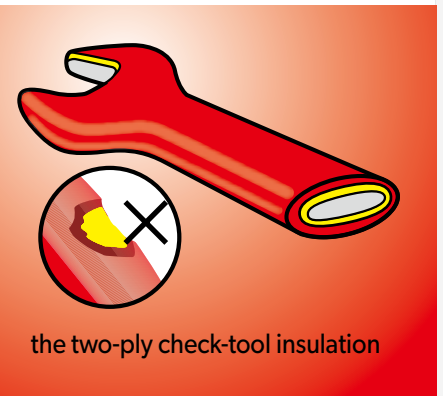

the two-ply check-tool insulation

6PCS INSULATED OPEN END SPANNER SET

- 6pcs Insulated open end spanners: 10mm, 12mm, 13mm, 14mm, 17mm, 19mm
- VDE/GS certificated
- Manufactured according to EN60900
- Chrome vanadium material body, entirely hardened and tempered
- Handle are dipped with double layers
- Packing: canvas bag with color box

PREMIUM

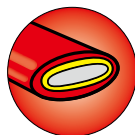

STOCK NO.	QTY./CARTON
V83606	10

INSULATED RING SPANNER

- VDE/GS certificated
- Manufactured according to EN60900
- Chrome vanadium material body, entirely hardened and tempered
- Handle are dipped with double layers
- Packing: plastic bag with paper hanger

PREMIUM

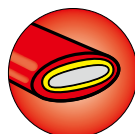

STOCK NO.	SIZE	QTY./CARTON
V40306	6mm	48
V40307	7mm	48
V40308	8mm	48
V40309	9mm	48
V40310	10mm	48
V40311	11mm	48
V40312	12mm	48
V40313	13mm	48
V40314	14mm	48
V40315	15mm	48
V40316	16mm	48
V40317	17mm	48
V40318	18mm	48
V40319	19mm	48
V40321	21mm	36
V40322	22mm	36
V40324	24mm	30
V40327	27mm	30
V40330	30mm	18
V40332	32mm	18

INSULATED ADJUSTABLE WRENCH

- VDE/GS certificated
- Manufactured according to EN60900
- Chrome vanadium material body, entirely hardened and tempered
- Chrome plated surface
- Packing: blister card

PREMIUM



STOCK NO.	SIZE	QTY./CARTON
V40520	200mm, 8"	18
V40525	250mm, 10"	12

INSULATED RATCHET RING SPANNER

- Manufactured according to EN60900
- Chrome vanadium material body, entirely hardened and tempered
- Handle are dipped with double layers
- 72 teeth, 5° working angle
- Packing: plastic bag with paper hanger

PREMIUM

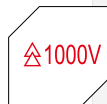
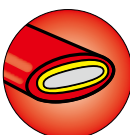

STOCK NO.	SIZE	QTY./CARTON
V42710	10mm	48
V42711	11mm	48
V42712	12mm	48
V42713	13mm	48
V42714	14mm	48
V42715	15mm	48
V42716	16mm	48
V42717	17mm	48
V42718	18mm	48
V42719	19mm	48

INSULATED CABLE KNIFE

- VDE/GS certificated
- Manufactured according to EN60900
- Stainless steel blade, entirely hardened and tempered;
- Packing: blister card

PREMIUM



STOCK NO.	SIZE	QTY./CARTON
V50418	50x180mm	36

INSULATED DISMANTLING KNIFE

- VDE/GS certificated
- Manufactured according to EN60900
- Stainless steel blade, entirely hardened and tempered;
- Packing: blister card

PREMIUM



STOCK NO.	SIZE	QTY./CARTON
V51416	38x155mm	36

INSULATED SCISSOR

- VDE/GS certificated
- Manufactured according to EN60900
- Stainless steel blade, entirely hardened and tempered
- Packing: blister card

PREMIUM



STOCK NO.	SIZE	QTY./CARTON
V90047	160mm	36

INSULATED BOLT CUTTER

- Manufactured according to EN60900
- Chrome vanadium blade, entirely hardened and tempered
- Chrome plated surface
- Insulated fiberglass handle with heavy duty TPR grips
- Packing: white box with color label

PREMIUM



STOCK NO.	SIZE	QTY./CARTON
V12224	600mm, 24"	5

15PCS INSULATED HAND TOOLS SET

PREMIUM

- 1pc 200mm insulated combination pliers
- 1pc 200mm insulated long nose pliers
- 1pc 160mm insulated diagonal cutting pliers
- 1pc 160mm insulated wire stripping pliers
- 5pcs insulated slotted screwdrivers: 0.4x2.5x75mm, 0.5x3.0x100mm, 0.8x4.0x100mm, 1.0x5.5x125mm, 1.2x6.5x150mm
- 4pcs insulated phillips screwdrivers: PH0x60mm, PH1x80mm, PH2x100mm, PH3x150mm
- 1pc 3.0x70mm voltage tester
- 1pc 50x180mm cable knife
- VDE/GS certificated
- Manufactured according to EN60900
- Packed strong plastic box with EVA inside
- One box Packing: color sleeve with shrink



XL

460x335x95 mm



STOCK NO.
V82115

QTY./CARTON
3

18PCS INSULATED HAND TOOLS SET

PREMIUM

- 1pc 200mm insulated dipped combination pliers
- 1pc 160mm insulated dipped long nose pliers
- 1pc 160mm insulated dipped diagonal cutting pliers
- 1pc 160mm insulated dipped wire stripping pliers
- 3pcs Insulated slotted screwdrivers: 0.4x2.5x75mm, 0.8x4.0x100mm, 1.0x5.5x125mm
- 3pcs insulated phillips screwdrivers: PH0x60mm, PH1x80mm, PH2x100mm
- 5pcs insulated open end spanners: 10mm, 12mm, 14mm, 17mm, 19mm
- 1pc 3.0x70mm voltage tester
- 1pc 50x180mm cable knife
- 1pc 250mm insulated adjustable wrench;
- VDE/GS certificated
- Manufactured according to EN60900
- Packed strong plastic box with EVA inside
- One box Packing: color sleeve with shrink



XL

460x335x95 mm



STOCK NO.
V83718

QTY./CARTON
3

25PCS INSULATED HAND TOOLS SET

PREMIUM

- 1pc 180mm insulated dipped combination pliers
- 1pc 180mm insulated dipped long nose pliers
- 1pc 160mm insulated dipped diagonal cutting pliers
- 2pcs insulated slotted screwdrivers: 0.8x4.0x100mm, 1.0x5.5x125mm
- 2pcs insulated slotted screwdrivers: PH1x80mm, PH2x100mm
- 14pcs 1/2" insulated dipped sockets: 10mm, 11mm, 12mm, 13mm, 14mm, 16mm, 17mm, 18mm, 19mm, 22mm, 24mm, 27mm, 30mm, 32mm
- 1pc 200mm insulated adjustable wrench
- 2pcs insulated extension bars: 1/2"x125mm, 1/2"x250mm
- 1pc 1/2"x250 insulated dipped reversible ratchet
- VDE/GS certificated
- Manufactured according to EN60900
- Packed strong plastic box with EVA inside
- One box Packing: color sleeve with shrink



XL

460x335x95 mm



STOCK NO.
V83825

QTY./CARTON
3





PAINTING & MASONRY TOOLS

WALL SCRAPER

- High quality tool steel, heat treated
- Fine polished
- Wooden handle
- Packing: color label



STOCK NO.	SIZE	QTY./CARTON
40201	35mm	120
40202	50mm	120
40204	75mm	120
40205	100mm	120

4PCS WALL SCRAPER SET

- High quality tool steel
- Fine polished
- Plastic handle
- Packing: polybag with paper hanger

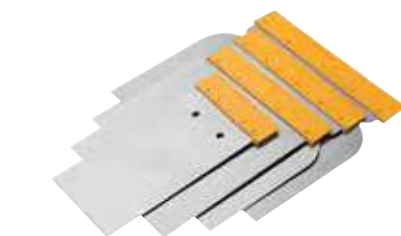

STOCK NO.	SIZE	QTY./CARTON
40008	50, 80, 100, 120mm	120

WALL SCRAPER

- High quality tool steel, heat treated
- Mirror polished
- Two-component TPR handle
- Packing: polybag with color label

GRIPPro series



STOCK NO.	SIZE	QTY./CARTON
40011	30mm, 1.2"	120
40012	40mm, 1.5"	120
40013	50mm, 2"	120
40014	60mm, 2.5"	120
40015	80mm, 3"	120
40016	100mm, 4"	120
40017	125mm, 5"	120
40018	150mm, 6"	120
40020	200mm, 8"	60
40021	250mm, 10"	60

DRYWALL TAPING KNIFE

- 65Mn blade, heat treated
- Blue finished surface
- Two-component handle
- Packing: color label

GRIPPro series



STOCK NO.	SIZE	QTY./CARTON
40023	200mm, 8"	48
40024	250mm, 10"	48
40025	300mm, 12"	48

6 IN 1 PUTTY KNIFE

- Scraper
- Putty remover
- Spreader
- Half round cutout to remove paint from roller
- Sharp point to open cracks from patching
- Middle hole to lift nails
- Fully hardened stainless steel blade
- Mirror polished
- Two-component plastic handle

GRIPPro series



STOCK NO.	SIZE	QTY./CARTON
40010	2.5"	72

WOODEN HANDLE PAINT BRUSH

- Special formulated PET & white bristle in chrome plated ferrule
- Wooden handle
- Packing: color label



STOCK NO.	SIZE	QTY./CARTON
40121	1"	600
40122	1.5"	480
40123	2"	360
40124	2.5"	240
40125	3"	180
40126	4"	120

3 PCS PAINT BRUSH SET

- Special formulated PET & white bristle in chrome plated ferrule
- Wooden handle
- Packing: skin card



STOCK NO.	SIZE	QTY./CARTON
40144	1"/1.5"/2"	72

3 PCS PAINT BRUSH SET

- Special formulated PET & white bristle in chrome plated ferrule
- wooden handle
- Packing: skin card



STOCK NO.	SIZE	QTY./CARTON
40145	2"/3"/4"	48

INDUSTRIAL

INDUSTRIAL

INDUSTRIAL

CEILING BRUSH

- White bristle & PET in chrome plated ferrule
- Plastic handle
- Packing: PVC bag with color label



STOCK NO.	SIZE	QTY./CARTON
40038	30x100x44mm	120
40040	40x140x51mm	72

PAINT BRUSH

- Flat paint brush , curved head
- White bristle & PET
- Stainless steel ferrule
- Fine polished wooden handle with hanging hole
- Packing: color label



STOCK NO.	SIZE	QTY./CARTON
40048	1"	360
40049	1.5"	300
40050	2"	240
40051	2.5"	180

PAINT ROLLER

- Material: polyester and acrylic
- Convenient and fast change the roller cover
- Using for outside wall or coarse wall surface
- Packing: polybag



STOCK NO.	SIZE	FIBRE HEIGHT	DIA. OF CENTRAL SHANK	QTY./CARTON
40054	225mm,9"	11mm	5.7mm	50

PAINT BRUSH

- Thicker hair brush
- Special formulated PET & white bristle in chrome plated ferrule
- Paint efficiency increased by more than 33%
- Ergonomic handle with anti-skid design, reducing hand fatigue effectively
- Packing: color sleeve



GRIPPro series



STOCK NO.	SIZE	BRISTLE LENGTH	THICKNESS	QTY./CARTON
40131	1"	51mm	17mm	360
40132	1.5"	51mm	19mm	360
40133	2"	57mm	19mm	240
40134	2.5"	57mm	21mm	240
40135	3"	64mm	23mm	120
40136	4"	64mm	23mm	120

PAINT MORE tech

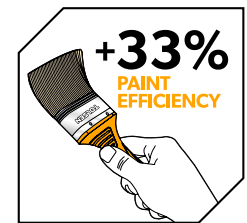

PAINT ROLLER

- Material: acrylic
- Convenient and fast change the roller cover
- Using for outside wall or coarse wall surface
- Packing: polybag



STOCK NO.	SIZE	FIBRE HEIGHT	DIA. OF CENTRAL SHANK	QTY./CARTON
40057	225mm,9"	7mm	5.7mm	50

PAINT ROLLER FRAME

- Steel wire with chrome plated
- Packing: polybag with color label



STOCK NO.	SIZE	DIA. OF CENTRAL SHANK	QTY./CARTON
40059	225mm,9"	5.7mm	50

ROLLER COVER

- Material: polyester and acrylic
- Convenient and fast change the roller cover
- Using for outside wall or coarse wall surface
- Packing: polybag



STOCK NO.	SIZE	FIBRE HEIGHT	QTY./CARTON
40070	225mm,9"	11mm	100
40071	225mm,9"	18mm	100

ROLLER COVER

- Material: acrylic
- Convenient and fast change the roller cover
- Using for outside wall or coarse wall surface
- Packing: polybag



STOCK NO.	SIZE	FIBRE HEIGHT	QTY./CARTON
40073	225mm,9"	7mm	100

PAINT ROLLER

- Material: polyester and acrylic
- Convenient and fast change the roller cover
- Using for outside wall or coarse wall surface
- Packing: polybag



STOCK NO.	SIZE	FIBRE HEIGHT	DIA. OF CENTRAL SHANK	QTY./ CARTON
40075	250mm,10"	11mm	7.8mm	50

PAINT ROLLER

- Material: acrylic
- Convenient and fast change the roller cover
- Using for outside wall or coarse wall surface
- Packing: polybag



STOCK NO.	SIZE	FIBRE HEIGHT	DIA. OF CENTRAL SHANK	QTY./ CARTON
40077	250mm,10"	7mm	7.8mm	50

PAINT ROLLER FRAME

- Steel wire with chrome plated
- Packing: polybag with color label



STOCK NO.	SIZE	DIA. OF CENTRAL SHANK	QTY./ CARTON
40079	250mm,10"	7.8mm	50

ROLLER COVER

- Material: polyester and acrylic
- Convenient and fast change the roller cover
- Using for outside wall or coarse wall surface
- Packing: polybag



STOCK NO.	SIZE	FIBRE HEIGHT	DIA. OF CENTRAL SHANK	QTY./ CARTON
40081	250mm,10"	11mm	7.8mm	50

ROLLER COVER

- Material: acrylic
- Convenient and fast change the roller cover
- Using for outside wall or coarse wall surface
- Packing: polybag



STOCK NO.	SIZE	FIBRE HEIGHT	DIA. OF CENTRAL SHANK	QTY./ CARTON
40083	250mm,10"	7mm	7.8mm	50

PAINT ROLLER FRAME

- Steel wire with chrome plated
- Dia of central shank: 5.7mm
- Packing: color label



STOCK NO.	SIZE	DIA. OF CENTRAL SHANK	QTY./ CARTON
40058	100mm,4"	5.7mm	100

ROLLER COVER

- Material: polyester and acrylic
- Using for outside wall or coarse wall surface
- Packing: polybag



STOCK NO.	SIZE	FIBRE HEIGHT	DIA. OF CENTRAL SHANK	QTY./ CARTON
40068	100mm,4"	12mm	5.7mm	200

PAINT ROLLER

- Material: polyester and acrylic
- Convenient and fast change the roller cover
- Packing: polybag



STOCK NO.	SIZE	LENGTH OF THE HANDLE	FIBRE HEIGHT	DIA. OF CENTRAL SHANK	QTY./ CARTON
40090	100mm,4"	400mm	11mm	5.7mm	100

PAINT ROLLER

- Material: acrylic
- Convenient and fast change the roller cover
- Packing: polybag



STOCK NO.	SIZE	LENGTH OF THE HANDLE	FIBRE HEIGHT	DIA. OF CENTRAL SHANK	QTY./ CARTON
40091	100mm,4"	400mm	4mm	5.7mm	100

ROLLER COVER

- Material: polyester and acrylic
- Convenient and fast change the roller cover
- Using for outside wall or coarse wall surface
- Packing: polybag



STOCK NO.	SIZE	FIBRE HEIGHT	DIA. OF CENTRAL SHANK	QTY./ CARTON
40092	100mm,4"	11mm	5.7mm	500

ROLLER COVER

- Material: acrylic
- Convenient and fast change the roller cover
- Using for outside wall or coarse wall surface
- Packing: polybag



STOCK NO.	SIZE	FIBRE HEIGHT	DIA. OF CENTRAL SHANK	QTY./ CARTON
40093	100mm,4"	4mm	5.7mm	500

EXTENSION POLE

- Powder coated
- Suitable for TOLSEN stock No.: 40054, 40057, 40059
- Extension pole connected with 40112, suitable for TOLSEN No.: 40075, 40077, 40079, 40090, 40091
- Packing: color label



STOCK NO.	SIZE	QTY./CARTON
40110	105-200cm	24
40111	155-300cm	24

PLASTIC ADAPTER FOR EXTENSION POLE

- Connect with TOLSEN STOCK : 40110 or 40111

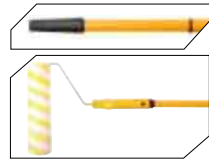

STOCK NO.	QTY./CARTON
40112	96

PAINT TRAY

- Plastic material
- Packing: color label



STOCK NO.	SIZE	QTY./CARTON
40096	360x285x75mm	50

3PCS PAINT ROLLER SET

- 1pc paint roller frame (TOLSEN 40059)
Dia. of central shank: 5.7mm
Size: 225mm,9"
- 1pc roller cover (TOLSEN 40070)
Material: polyester and acrylic
Fibre height: 11mm
Size: 225mm,9"
- 1pc paint tray
Size: 360x270x60mm
Material: PP
- Packing: color label with shrink



STOCK NO.	SIZE	QTY./CARTON
40088	360x285x75mm	12

PAINT MIXER (HEX SHANK)

- Special tool steel with powder coating
- Rubber hanging hole
- Packing: PE bag with color label



STOCK NO.	SIZE	QTY./CARTON
40098	400x80x8mm	40
40099	600x100x10mm	20

PAINT MIXER (SDS-PLUS SHANK)

- Special tool steel with powder coating
- Rubber hanging hole
- Packing: PE bag with color label



STOCK NO.	SIZE	QTY./CARTON
40101	400x80x10mm	40
40102	600x100x10mm	20

BRICKLAYING TROWEL

- Wooden handle
- Packing: polybag with color sticker



STOCK NO.	SIZE	DIA. OF CONNECTING ROD	QTY./ CARTON
41008	130mm,5"	7.5mm	72
41000	150mm,6"	7.5mm	72
41001	175mm,7"	9.5mm	48
41002	200mm,8"	9.5mm	48

BRICKLAYING TROWEL

- Plastic handle
- Packing: polybag with color sticker

GRIPPro
series



STOCK NO.	SIZE	DIA. OF CONNECTING ROD	QTY./ CARTON
41050	130mm, 5"	7.5mm	72
41051	150mm, 6"	7.5mm	72
41052	175mm, 7"	9.5mm	48
41053	200mm, 8"	9.5mm	48

BRICKLAYING TROWEL

- Plastic handle
- Packing: polybag with color sticker

GRIPPro
series



STOCK NO.	SIZE	DIA. OF CONNECTING ROD	QTY./ CARTON
41061	160mm, 6"	8mm	72
41062	180mm, 7"	9.5mm	48
41063	200mm, 8"	9.5mm	48
41064	220mm, 9"	9.5mm	48

BRICKLAYING TROWEL

- Plastic handle
- Packing: polybag with color sticker

GRIPPro
series



STOCK NO.	SIZE	DIA. OF CONNECTING ROD	QTY./ CARTON
41003	150mm, 6"	7.5mm	72
41004	175mm, 7"	9.5mm	72
41005	200mm, 8"	9.5mm	48

BRICKLAYING TROWEL

- Plastic handle
- Packing: polybag with color sticker

GRIPPro
series



STOCK NO.	SIZE	DIA. OF CONNECTING ROD	QTY./ CARTON
41055	140x85x105mm	9.5mm	72
41056	160x85x110mm	9.5mm	72
41057	180x90x115mm	9.5mm	48
41058	200x90x120mm	9.5mm	48

PLASTERING TROWEL

- Wooden handle
- Packing: polybag with color sticker



STOCK NO.	SIZE	QTY./CARTON
41012	280x120mm	48

PLASTERING TROWEL WITH TEETH

- Wooden handle
- With teeth: 10x10mm
- Packing: polybag with color sticker



STOCK NO.	SIZE	QTY./CARTON
41013	280x120mm	48

PLASTERING TROWEL

- Plastic handle
- Stainless steel
- Packing: polybag with color sticker

GRIPPro
series



STOCK NO.	SIZE	QTY./CARTON
41016	280x120mm	48

PLASTERING TROWEL WITH TEETH

- Plastic handle
- Stainless steel
- With teeth: 10x10mm
- Packing: polybag with color sticker

GRIPPro
series



STOCK NO.	SIZE	QTY./CARTON
41017	280x120mm	48

FOAM TROWEL

- Material: EVA
- Packing: polybag with color sticker



STOCK NO.	SIZE	QTY./CARTON
41019	230x100x10mm	48

INDUSTRIAL

INDUSTRIAL

FOAM TROWEL

- Material: Rubber
- Packing: play bag with color sticker



STOCK NO.	SIZE	QTY./CARTON
41022	240x100x19mm 4" x 9-1/2" x 3/4"	48

FOAM TROWEL

- PS Plastic handle
- TPR BASE
- Packing: polybag



STOCK NO.	SIZE	QTY./CARTON
41018	250x95x13mm	48

ALUMINIUM LEVEL

- Material: Aluminium
- Thickness: 1.0mm
- Packing: color label with shrink

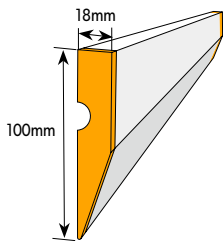

STOCK NO.	SIZE	QTY./CARTON
41080	1m/40"	10
41081	1.5m/60"	10
41082	2m/80"	10
41083	2.5m/100"	10
41084	3m/120"	10

GLASS CUTTER

- Wooden handle
- With 6pcs wheels TCT blade
- Chrome finished
- Packing: blister card



STOCK NO.	SIZE	QTY./CARTON
41030	130mm	240

HEAVY DUTY GLASS CUTTER

- Plastic handle
- High quality TCT blade
- Packing: blister card



STOCK NO.	SIZE	QTY./CARTON
41031	178mm	240

HEAVY DUTY GLASS CUTTER

- Tungsten carbide blade
- Ideal for glass thickness from 4 to 10mm iron body
- Auto oil feed system
- Total cutting length: 6000m/1pc wheel blade
- Packing: blister card



STOCK NO.	SIZE	QTY./CARTON
41029	175mm	120

TILE CUTTER

- Replaceable cutting blades: Ø15xØ6x1.5mm
- Max cutting: 10mm
- Packing: color box



STOCK NO.	SIZE	QTY./CARTON
41033	400mm	10

TILE CUTTER

- Replaceable cutting blades: Ø15xØ6x1.5mm
- Max cutting thickness: 12mm
- Packing: color box



ALUMINIUM BASE AND SUPPORT PARTS



THICK EVA TO PROTECT TILES



ADJUSTABLE MEASURING GUIDE

STOCK NO.	SIZE	QTY./CARTON
41032	600mm	4

BLADE FOR TILE CUTTER

- High quality TCT material: YG6X
- Suitable for TOLSEN stock No. **41032** and **41033**
- Packing: skin card



STOCK NO.	SIZE	QTY./CARTON
41037	Ø15xØ6x1.5mm	200

INDUSTRIAL

INDUSTRIAL

HEAVY DUTY TILE CUTTER

- Replaceable cutting blades: $\varnothing 22 \times \varnothing 10.5 \times 2 \text{mm}$
- Max. cutting thickness : 12mm
- Packing: color box



LONGER LIFE
BLADE



ALUMINIUM
BASE AND
SUPPORT
PARTS



THICK EVA
TO PROTECT
TILES



ADJUSTABLE
MEASURING
GUIDE



CUT 45°
ANGLE

STOCK NO.	SIZE	QTY./CARTON
41034	800mm	2

HEAVY DUTY TILE CUTTER

- Replaceable cutting blades: yg6x, $\varnothing 22 \times \varnothing 6 \times 2 \text{mm}$
- For parallel & angled ($0^\circ - 60^\circ$) cuts
- Die casting cutting assembly with ball bearing
- Sliding ball support large tile moving
- Stopping rod support mass tile cutting
- Max cutting thickness: 12mm
- Thickness of base: 1.8mm
- Packing: color box



STOCK NO.	SIZE	QTY./CARTON
41035	600mm	2

INDUSTRIAL

HEAVY DUTY TILE CUTTER

- Heavy duty Tile cutter
- Max. cutting length: 1200mm
- Max. cutting thickness: 14mm
- Tungsten carbide ball bearing
- blade: $\varnothing 22 \times \varnothing 6 \times 6 \text{mm}$
- Steel base: 1390x175x27mm With 2pcs steel support frame
- Thickness of the base: 1.8mm
- For Parallel and angled cutting ($0 - 60^\circ$)
- Die casting cutting assembly with ball bearing
- Sliding ball support large tile moving
- Stopping rod support mass tile cutting
- Ergonomic curved non-slip plastic handle

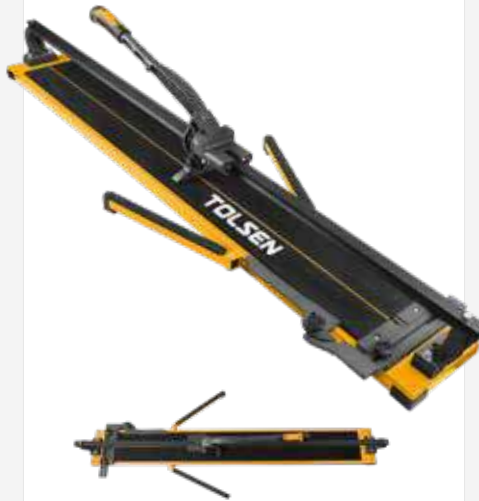

STOCK NO.	SIZE	QTY./CARTON
41036	1200mm	2

BLADE FOR TILE CUTTER

- High quality TCT material: YG6X
- Suitable for TOLSEN stock No. 41034
- Packing: skin card



STOCK NO.	SIZE	QTY./CARTON
41038	$\varnothing 22 \times \varnothing 10.5 \times 2 \text{mm}$	50

BLADE FOR TILE CUTTER

- High quality TCT material: YG6X
- Suitable for TOLSEN stock No. 41035
- Packing: skin card



STOCK NO.	SIZE	QTY./CARTON
41039	$\varnothing 22 \times \varnothing 6 \times 2 \text{mm}$	200

INDUSTRIAL

INDUSTRIAL

INDUSTRIAL

ALUMINUM ALLOY MULTI ANGLE MEASURING SIX-FOLD RULER

- A single fold length: 17.5cm
- Portable and lightweight for easy carry, made of sturdy premium aluminum alloy, use for very long time
- A universal layout measuring tool while working in tiles, brick pavers, lumber, laminate, wood, flooring project and more.
- Upgrade with a locator design to help mark the position and drill the hole on tile which you need.
- Two sides of length unit, CM & IN by laser etched marking, it will be available for everyone who loves DIY.
- Multi-function metal measuring tools for construction, foldable ruler at any angle to meet your daily needs.
- Packing: color box

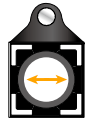

$\varnothing 45 \text{mm}$



$\varnothing 40 \text{mm}$



$\varnothing 25 \text{mm}$



STOCK NO.	QTY./CARTON
41045	50

TILE GROUT SAW

- Material: high quality plastic and hard metal, "diamond style" blade help you remove grout with minimal effort
- Tile grout ripper has a angled head for removing grout from the hard to reach places the machine can't reach, easy to use
- Ergonomic Handle: This is a handy little tool for cleaning out the old grout
- 1pc extra blade can be easily replaced and keep you going until the job is done.
- Packing: blister card



STOCK NO.	SIZE	QTY./CARTON
41047	50X2.2mm	60

PLANER

- Material of handle: PP
- Packing: color box



STOCK NO.	SIZE	QTY./CARTON
42000	235x44mm	24

BLOCK PLANER

- Aluminium alloy body
- ABS plastic handle
- Packing: paper hanger



STOCK NO.	SIZE	QTY./CARTON
42002	250x40mm	40

BLOCK PLANER

- ABS plastic body
- Packing: paper hanger



STOCK NO.	SIZE	QTY./CARTON
42003	250x40mm	40

PLANER BLADE

- Suit for TOLSEN No.42002 & 42003
- Special tool steel, black plated
- Packing: polybag+header

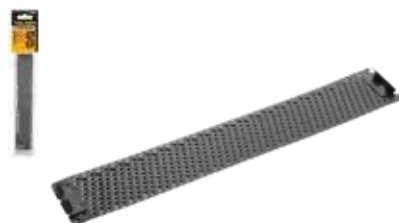

STOCK NO.	SIZE	QTY./CARTON
42008	250mm	120

CHALK LINE REEL SET

- 1pc chalk line reel 30m
- 3 times speed faster rewind
- 1pc spirit bubble
- 1pc blue powder bottle: 115g
- Packing: double blister

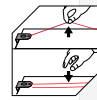

BLUE
POWDER

3x
FASTER
REWIND

STOCK NO.	QTY./CARTON
42013	48

CHALK POWDER

- Weight: 8oz/225g
- Packing: color label



STOCK NO.	SIZE	QTY./CARTON
42017	Blue	60
42018	Red	60
42019	White	60

CARPENTER PENCIL

- Oval
- 12pcs packed in color box



x12

STOCK NO.	PENCIL SIZE	PENCIL LEAD SIZE	QTY./CARTON
42021	12x7.4x176mm	5.0x2.0mm	72

CARPENTER PENCIL (BI-COLOR)

- Oval
- 12pcs packed in color box



x12

STOCK NO.	PENCIL SIZE	PENCIL LEAD SIZE	QTY./CARTON
42022	10x7.5x176mm	4.0x2.0mm	72

PERMANENT MARKER, BLACK

- Paint marker used for industry
- Oil based opaque ink, can past test of ASTM and EN71. light resistant, waterproof, dry fast, low odour.
- Suitable writing on surface such as glass, paper, plastic, metal, wood and porcelain etc.
- Packing: 12pcs in one color box



STOCK NO.	SIZE	WRITING WIDTH	WRITING DISTANCE	QTY./CARTON
42025	143x15mm	2mm	300m	720

PERMANENT MARKER, RED

- Paint marker used for industry
- Oil based opaque ink, can past test of ASTM and EN71. light resistant, waterproof, dry fast, low odour.
- Suitable writing on surface such as glass, paper, plastic, metal, wood and porcelain etc.
- Packing: 12pcs in one color box



STOCK NO.	SIZE	WRITING WIDTH	WRITING DISTANCE	QTY./CARTON
42026	143x15mm	2mm	300m	720

SUPER GLUE (INCLUDED 12PCS)

- Material: 100% purity glue
- Bond in 5 seconds
- Net weight: 3g
- 24 months guarantee
- Bullet cap for easy using
- Color: Clear
- Application: Plastics, leather, metal, ceramic and wood.
- 12Pcs/Set
- Packing: skin card



STOCK NO.	QTY./CARTON
50190	72SETS

CAULKING GUN

- Aluminium body, steel trigger
- Packing: hang tag



STOCK NO.	SIZE	QTY./CARTON
43041	225mm,9"	24

CAULKING GUN

- Pressed steel, gear pushing bar
- Packing: color label



STOCK NO.	SIZE	QTY./CARTON
43042	225mm,9"	24

HEAVY DUTY CAULKING GUN

- Aluminium body
- Packing: color label



STOCK NO.	SIZE	QTY./CARTON
43049	225mm,9"	24

CAULKING GUN

- Aluminium body, steel trigger
- Packing: color label



STOCK NO.	SIZE	QTY./CARTON
43050	225mm,9"	24

CAULKING GUN

- Pressed steel body, powder coated
- Aluminum trigger
- Packing: color label



STOCK NO.	SIZE	QTY./CARTON
43052	225mm,9"	24

3-IN-1 HEAVY DUTY CAULKING GUN

- Pressed steel, power plated
- Serrated groove shaft, with cutter
- Packing: color label



STOCK NO.	SIZE	QTY./CARTON
43043	225mm,9"	24

PROFESSIONAL CAULKING GUN

- Aluminium tube body with shaft pusher
- Aluminium cover
- Aluminium lock nut
- Heavy duty aluminium handles
- with 1pc plastic nozzle
- Packing: color label



STOCK NO.	SIZE	QTY./CARTON
43044	225mm,9"	12

PROFESSIONAL CAULKING GUN

- Aluminium tube body with shaft pusher
- Aluminium cover
- Aluminium lock nut
- Heavy duty aluminium handles
- with 1pc plastic nozzle
- Packing: color label



STOCK NO.	SIZE	QTY./CARTON
43046	375mm,15"	12

PLASTIC NOZZLE FOR ALUMINIUM CAULKING GUN

- Material: PP
- Match with TOLSEN 43044 and 43046
- 5pcs packed in PE bag



STOCK NO.	QTY./CARTON
43048	40sets

FOAM GUN

- Aluminium alloy body metal trigger
- Heavy duty design
- Stainless steel needle
- The adjusting screw make the foam flow fluently
- Individually tested by air pressure
- Packing: color box



STOCK NO.	QTY./CARTON
43060	20

INDUSTRIAL

INDUSTRIAL

INDUSTRIAL

INDUSTRIAL

INDUSTRIAL



PPE

WORKING GLOVES

- Weight: 600g/doz
- Material: cotton and polyester, class A
- Knitted wrist
- One dozen in a polybag with color sticker



x12

STOCK NO.	SIZE	QTY./CARTON
45001	10(XL)	10 DOZENS

WORKING GLOVES

- Weight: 580g/doz
- Material: polyester
- Knitted wrist
- One dozen in a polybag with color sticker



x12

STOCK NO.	SIZE	QTY./CARTON
45002	10(XL)	10 DOZENS

MECHANIC GLOVES

- EVA foam padding absorbs and dissipates high-impact energy through the palm
- Molded PVC knuckle guards and full-length fingertip protection reduce the risk of impact and pinching injuries.
- Form-fitting material keeps your hands cool and comfortable while you work.
- Dual-layer internal fingertip reinforces the index finger and thumb for added durability.
- Durable synthetic leather palm.
- Flexible closure provides a secure fit to the wrist.
- Packing: paper hanger



STOCK NO.	SIZE	QTY./CARTON
45047	XL	72

WORKING GLOVES

- Material: polyester
- Yellow nitrile
- Knitted wrist
- Excellent comfort and fit
- Outstanding dexterity
- Excellent puncture resistance at palm, long lasting and perspiration-free, long wearing
- One dozen in a polybag with color sticker



x12

STOCK NO.	SIZE	QTY./CARTON
45010	10(XL)	10 DOZENS

HEAVY DUTY LATEX COATED PALM GLOVES

- CE approval
- Material of liner: Polyester
- With natural latex coated palms and fingertips
- Knitted wrist
- Excellent comfort and fit
- Outstanding dexterity
- Excellent puncture resistance at palm, long lasting and perspiration-free, long wearing
- Packing: paper card



EN388
3131X



STOCK NO.	SIZE	QTY./CARTON
45016	10(XL)	120

MECHANIC GLOVES

- Form-fitting helps keep hands cool and comfortable.
- Double-stitched index finger construction improves durability.
- Flexible closure provides a secure fit to the wrist.
- Packing: paper hanger



STOCK NO.	SIZE	QTY./CARTON
45044	XL	72

LEATHER WORKING GLOVES

- CE approved
- Material: cow split leather
- Black cow split leather palm rest
- Packing: paper hanger



STOCK NO.	SIZE	QTY./CARTON
45024	10(XL)	72

CUT RESISTANCE PROTECTIVE GLOVES

- CE approved
- 13G cut resistance liner with PU palm coated
- Seamless HPPE liner offers extraordinary comfort and cut protection
- 13 Gauge offers super thin and more comfortable
- Polyurethane coating offers incredible grip and abrasion resistance
- Durable protection for long time wearing
- Packing: paper hanger

INDUSTRIAL



EN388
4X42C



STOCK NO.	SIZE	QTY./CARTON
45040	9"	60
45041	10"	60

SAFETY GOGGLE

- CE and ANSI approved
- Expert quality made from impact resistant polycarbonate
- Gives clear distortion free viewing
- Adjustable leg of frame for comfortable use and fit
- Packing: polybag with paper hanger



ANSI



4-positions
adjustable
length
temples



STOCK NO.	QTY./CARTON
45071	100

SAFETY GOGGLE (CLEAR)

- CE and ANSI approved
- Expect quality made from Impact resistant polycarbonate
- Gives clear distortion free viewing
- Adjustable leg of frame for comfortable use and fit
- Color of the Lens: nature
- PA frame, PC lens
- With safety rope, prevent the goggle from falling
- Packing: paper hanger and color box

INDUSTRIAL



ANSI



Anti scratch



Anti UV



Anti shock



Comfortable rubber nose pad

4-positions
adjustable
length
temples



3-positions
adjustable
angle
temples



STOCK NO.	QTY./CARTON
45069	80

SAFETY GOGGLE

- Made from high-performance polycarbonate
- Light weight, comfortable to wear, wide visual field
- Impact resistant
- Packing: polybag with paper hanger



STOCK NO.	QTY./CARTON
45073	100

SAFETY GOGGLE

- CE and ANSI approved
- Full view design
- Impact resistant
- Fit to wearing the corrective glasses, also can be used as visitors glasses.
- Can defend against splash particles in the round
- Packing: polybag with paper hanger



ANSI



STOCK NO.	QTY./CARTON
45072	100

SAFETY GOGGLE

- CE approved to EN166
- Impact resistant
- Soft and light weight PVC frame with air holes
- High-impact polycarbonate lenses have high transparency comfortable for wearing.
- Packing: polybag with paper hanger



STOCK NO.	QTY./CARTON
45074	100

EAR PLUG

- Conforms to ear structure, safe and sanitary
- Made from polyurethane foam, smooth and ultra supple; superior noise reduction effect, let operators keep acute hearing in noise ambient.
- Packing: OPP bag



STOCK NO.	QTY./CARTON
45081	2000

EAR MUFF

- CE and ANSI approved
- Self-aligning suspension, easily adjusts muffs on headband for quick fitting
- Soft foam-filled cushion provides good seal for protection against harmful noise
- SNR: 26dB, NRR=21dB
- Packing: paper hanger



ANSI



STOCK NO.	QTY./CARTON
45083	60

SAFETY HELMET

- CE approved
- PP plastic body
- Buckle adjustment
- Chin strap included
- Four-point suspension
- With slots on both sides to equip face shield or other sound insulation products
- Packing: polybag with color sticker



STOCK NO.	SIZE	QTY./CARTON
45188	YELLOW	20
45189	BLUE	20
45190	RED	20
45191	WHITE	20

FACE SHIELD

- CE approved
- HDPE headgear
- PC face shield
- Ratchet adjustment suspension with sweatband for improve comfort
- Flip up for different viewing angles
- Packing: color label



STOCK NO.	QTY./CARTON
45182	40

REFLECTOR VEST

- CE-approved
- Polyester
- 5cm width high reflective tape
- Packing: polybag



STOCK NO.	SIZE	QTY./CARTON
45102	S	100
45103	M	100
45092	L	100
45093	XL	100
45094	XXL	100
45095	XXXL	100

REFLECTOR VEST

- Polyester
- 5cm width high reflective tape
- Packing: polybag



STOCK NO.	SIZE	QTY./CARTON
45110	L	100
45111	XL	100
45112	XXL	100
45113	XXXL	100

REFLECTOR VEST

- CE-approved
- Polyester tricot waistcoat
- 5cm width high reflective tape
- Packing: polybag with color label



STOCK NO.	SIZE	QTY./CARTON
45151	L	100
45152	XL	100

SAFETY BOOT

- Material: PVC
- Steel toe cap and steel midsole
- High level oil, acid, alkali resistance ,100% waterproof
- Deslitching shoe sole
- Packing: polybag with color label



IMPACT RESISTANCE



PENETRATION RESISTANCE



ANTI-STATIC



ENERGY ABSORPTION



OIL AND FUEL RESISTANCE



S5



STOCK NO.	US	UK	EU	QTY./CARTON
45115	7.5	6.5	40#	6
45116	8	7	41#	6
45117	9	8	42#	6
45118	10	9	43#	6
45119	11	10	44#	6
45120	11.5	10.5	45#	6

RAIN BOOT

- Virgin PVC/Nitril material
- Height:37cm
- High Level Oil, Acid, Alkali resistance
- 100% waterproof
- Anti-slip sole
- Packing: plastic bag with color label



ANTI-STATIC



ENERGY ABSORPTION



OIL AND FUEL RESISTANCE



STOCK NO.	US	UK	EU	QTY./CARTON
45125	7.5	6.5	40#	6
45126	8	7	41#	6
45127	9	8	42#	6
45128	10	9	43#	6
45129	11	10	44#	6
45130	11.5	10.5	45#	6

SAFETY BOOT

- CE approved to EN20345-S1P
- Steel toe cap
- Steel midsole
- Anti-static & Anti-Vibration & Oil resistant & Slip resistant
- Split leather upper
- Dual density pu sole
- Packing: color box



SIP

CE

INDUSTRIAL

STOCK NO.	US	UK	EU	QTY./CARTON
45351	7	6	39#	10
45352	7.5	6.5	40#	10
45353	8	7	41#	10
45354	9	8	42#	10
45355	10	9	43#	10
45356	11	10	44#	10
45357	11.5	10.5	45#	10
45358	12	11	46#	10



IMPACT RESISTANCE



BREATHABILITY



OIL AND FUEL RESISTANCE



PENETRATION RESISTANCE



ANTI-STATIC



ENERGY ABSORPTION



ANTI-SLIP

SAFETY BOOT

- CE approved to EN20345-S1
- Steel toe cap
- Anti-static & Anti-Vibration & Oil resistant & Slip resistant
- Split leather upper
- Dual density pu sole
- Packing: color box



S1

CE

INDUSTRIAL

STOCK NO.	US	UK	EU	QTY./CARTON
45321	7	6	39#	10
45322	7.5	6.5	40#	10
45323	8	7	41#	10
45324	9	8	42#	10
45325	10	9	43#	10
45326	11	10	44#	10
45327	11.5	10.5	45#	10
45328	12	11	46#	10



IMPACT RESISTANCE



BREATHABILITY



OIL AND FUEL RESISTANCE



ANTI-STATIC



ENERGY ABSORPTION



ANTI-SLIP

SAFETY BOOT

- CE Approval
- Cow leather
- EN20345-S1
- Steel toe cap
- Anti-static
- Anti-Vibration
- Oil resistant
- Slip resistant
- Dual density pu sole
- Packing: color box



S1

CE

INDUSTRIAL

STOCK NO.	US	UK	EU	QTY./CARTON
45381	7	6	39#	10
45382	7.5	6.5	40#	10
45383	8	7	41#	10
45384	9	8	42#	10
45385	10	9	43#	10
45386	11	10	44#	10
45387	11.5	10.5	45#	10
45388	12	11	46#	10



IMPACT RESISTANCE



BREATHABILITY



OIL AND FUEL RESISTANCE



ANTI-STATIC



ENERGY ABSORPTION

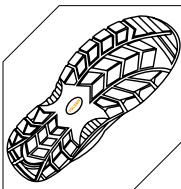

ANTI-SLIP

SAFETY BOOT

- SB standard
- Steel toe cap
- Flyknit upper, Good breathability
- Dual density pu sole
- Packing: color box



NEW

SB

CE

STOCK NO.	US	UK	EU	QTY./CARTON
45371	7	6	39#	10
45372	7.5	6.5	40#	10
45373	8	7	41#	10
45374	9	8	42#	10
45375	10	9	43#	10
45376	11	10	44#	10
45377	11.5	10.5	45#	10
45378	12	11	46#	10



IMPACT RESISTANCE



BREATHABILITY



OIL AND FUEL RESISTANCE



ENERGY ABSORPTION

KNEE PADS

- CE approved
- Professional design for comfortable use
- Soft and flexible material gives your knees well protection
- Packing: polybag with paper hanger



CE

STOCK NO.	QTY./CARTON
45106	24

KNEE PADS

- CE approved
- Thick foam knee pads with gel-effect cushions
- Pads are secured with hook and loop straps
- Professional design for comfortable use
- Soft and flexible material gives your knees well protection
- Packing: color box



CE

STOCK NO.	QTY./CARTON
45105	16

WORKING JACKET

- Material: 80% Polyester + 20% Cotton
- Two chest pockets with flaps
- Two pen holders on chest
- Two deep front patch pockets
- Elasticated cuffs
- Adjustable hem with two buttons positions each side
- Piping detail to front and back incorporating scotchlite reflective materials
- Full front zip fastening with three hook and loop positions
- With vents
- Special pockets for building accessories, for instance screws
- Packing: PVC bag with color paper



SIZE CHART

Model No.	45210	45211	45212	45213	45214	45215
SIZE	S	M	L	XL	XXL	XXXL
CHEST	55	58	61	64	67	70
SHOULDER WIDTH	50.5	52	53.5	55	56.5	58
FRONT BODY LENGTH	70	72	74	76	78	80

STOCK NO.	SIZE	QTY./CARTON
45210	S	10
45211	M	10
45212	L	10
45213	XL	10
45214	XXL	10
45215	XXXL	10

WORKING TROUSERS

- Material: 80% Polyester + 20% Cotton
- Reinforcements with Oxford fabric on knees durable
- Triple seam in spots prone to tearing reflective piece around the chest to improve user's safety
- Can be used with knee foam pads
- Zipper closure type
- Two front pockets, each has a extra wide front patch pockets
- Two wide lined back pockets with flaps
- One side pocket with flap
- One hammer loop
- Knee pad pockets
- Slim Fit
- Packing: PVC bag with color paper

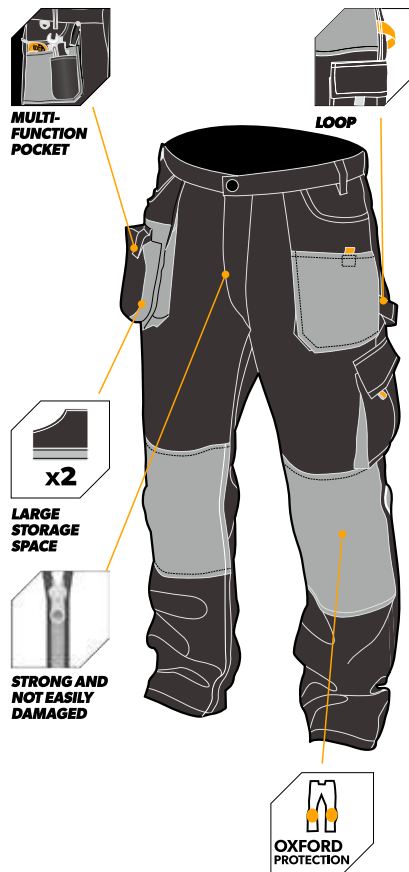

SIZE CHART

Model No.	45216	45217	45218	45219	45220	45221
SIZE	S	M	L	XL	XXL	XXXL
WAIST	42	44	46	48	51	54
HIP WIDTH	51	53	55	57	60	63
LEGGING OPENING	21	22	23	24	25	26
OUTSEAM (including waistband)	104	106	108	110.5	113	115.5

STOCK NO.	SIZE	QTY./CARTON
45216	S	10
45217	M	10
45218	L	10
45219	XL	10
45220	XXL	10
45221	XXXL	10

WORKING OVERALLS

- Material: 80% Polyester + 20% Cotton
- Additional belt for size adjustment
- Reinforcements with Oxford fabric on knees durable
- Triple seam in spots prone to tearing reflective piece around the chest to improve user's safety
- Can be used with knee foam pads
- With smartphone pocket
- Two front pockets, each has a extra wide front patch pockets
- Two wide lined back pockets with flaps
- One side pocket with flap
- One hammer loop
- Knee pad pockets
- Slim Fit
- Packing: PVC bag with color paper

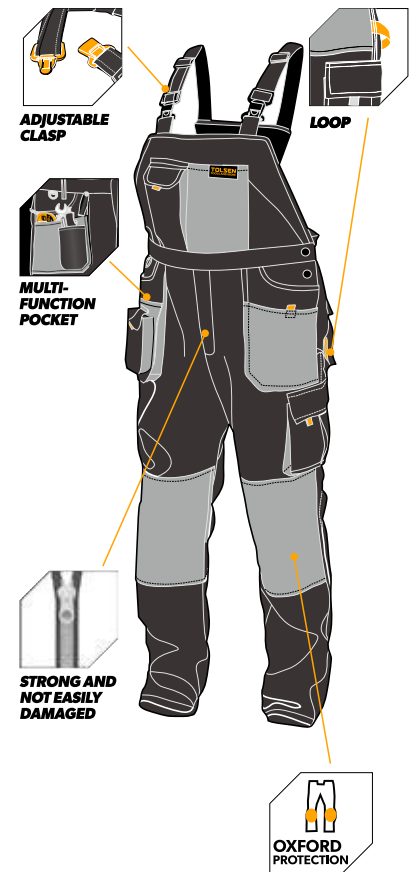

SIZE CHART

Model No.	45222	45223	45224	45225	45226	45227
SIZE	S	M	L	XL	XXL	XXXL
OUTSEAM (including waistband)	104	106	108	110.5	113	115.5
SIT	54	56	58	60	63	66
LEGGING OPENING	21	22	23	24	25	26
STRAP LEATH (including elastic)	65	65	70	70	75	75

STOCK NO.	SIZE	QTY./CARTON
45222	S	10
45223	M	10
45224	L	10
45225	XL	10
45226	XXL	10
45227	XXXL	10

SAFETY HARNESS

- Full body harness
- Comply with CE requirements
- Shoulder & thigh strap with dual color
- 45mm polyester webbing
- Adjustable thigh and chest strap
- 1pc anti-falling dorsal D-ring
- Packing: color box



STOCK NO.	QTY./CARTON
45261	10

SAFETY HARNESS

- Full body harness
- Comply with ANSI requirements
- Shoulder & thigh strap with dual color
- 45mm polyester webbing
- Adjustable shoulder, thigh and chest strap
- 1pc anti-falling dorsal D-ring on the back
- Chest strap position can be adjusted vertically
- Packing: color box



STOCK NO.	QTY./CARTON
45266	10

TOOL LANYARDS

- CE approval
- 1.5m high quality kernmantle rope
- Alloy steel material karabiner
- For use with tools working at height
- Safety karabiner for attaching to belt loop or tool belt
- Retaining ring for attachment to tool
- Packing: color box



STOCK NO.	SIZE	QTY./CARTON
45271	1.8m	10

ENERGY ABSORBER WEBBING LANYARDS

- CE approval
- 45mm polyester webbing with sewn terminations
- Energy absorber: polyester material
- The working height needs to be more than 6 meters
- Forged steel material karabiner
- Packing: color box



STOCK NO.	TOTAL LENGTH	QTY./CARTON
45276	2M	10

BACK SUPPORT BELT WITH ADJUSTABLE SUSPENDERS

- Tapered front panels for comfort while bending
- Wide elastic adjustable suspenders
- Internal stays provide extra support
- Packing: double blister



STOCK NO.	SIZE	QTY./CARTON
45241	S / 100cm	16
45242	M / 110cm	16
45243	L / 120cm	16
45244	XL / 130cm	16

RAIN SUIT

- 100% New PVC
- Reinforced lining
- Thickness: 0.32mm
- Two down pockets with flap
- With hood
- Zipper and snap buttons
- Packing: PE bag with color paper



STOCK NO.	SIZE	QTY./CARTON
45197	L	12
45198	XL	12
45199	XXL	12

RAINCOAT

- 100% new PVC
- Thickness: 0.32mm
- Packing: PVC bag with color sticker



STOCK NO.	SIZE	QTY./CARTON
45096	M	16
45097	L	16
45098	XL	16
45099	XXL	16
45100	XXXL	16



AUTOMOTIVE TOOLS

2-JAW GEAR PULLER

- Overall drop forged special tool steel with hardened treatment
- Zinc plated surface treatment
- Thread: black finished
- Packing: drawing box



STOCK NO.	A(max)	QTY./CARTON
65000	3"	20
65001	4"	20
65002	6"	12
65003	8"	6

3-JAW GEAR PULLER

- Overall drop forged special tool steel with hardened treatment
- Zinc plated surface treatment
- Thread: black finished
- Packing: drawing box



STOCK NO.	A(max)	QTY./CARTON
65010	3"	20
65011	4"	20
65012	6"	12
65013	8"	6

2-JAW GEAR PULLER

- CrV
- Overall forged steel with hardened treatment
- Chrome plated surface treatment
- Thread: black finished
- Packing: color box



STOCK NO.	A(max)	QTY./CARTON
65020	3"	20
65021	4"	16
65022	6"	8
65023	8"	4

3-JAW GEAR PULLER

- CrV
- Overall forged steel with hardened treatment
- Chrome plated surface treatment
- Thread: black finished
- Packing: color box



STOCK NO.	A(max)	QTY./CARTON
65030	3"	20
65031	4"	16
65032	6"	8
65033	8"	4

2-JAW GEAR PULLER

- Overall drop forged special tool steel with hardened treatment
- Zinc plated surface treatment
- Thread: Black finished
- Packing: color box

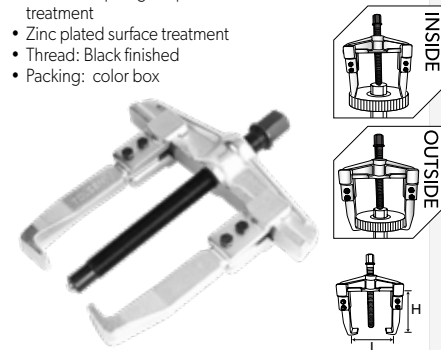

STOCK NO.	OPERATING RANGE (LxH)	QTY./CARTON
65040	90x100mm	16
65041	130x100mm	12
65042	160x150mm	6
65043	200x150mm	4

THREE LEG OIL FILTER WRENCH

- High quality carbon steel with heat treatment
- Stain finished
- 3/8" Square Drive with 1/2" adapter
- Ideal for use on car and commercial vehicle oil filters
- Packing: double blister



STOCK NO.	SIZE	QTY./CARTON
65110	65-120mm	24

GREASE GUN

- Capacity: 400cc
- Max pressure: 8500PSI
- Material: steel
- Comfortable plastic handle
- With 1pc 300mm flexible hose
- With 1pc 150mm steel hose
- Packing: color box



STOCK NO.	CAPACITY	QTY./CARTON
65200	400cc	12

FLEXIBLE TUBE FOR GREASE GUN

- Match with TOLSEN 65200
- M10x1.0
- Packing: polybag



STOCK NO.	SIZE	QTY./CARTON
65202	8x300mm	100

OIL CAN

- Iron body with yellow powder coated
- Flexible spout
- Iron robust pump with zinc plated
- O-seal ring in the cover
- Packing: color label



STOCK NO.	SIZE	QTY./CARTON
65223	300ml	60
65225	500ml	48

PE FUNNEL

- With stainless steel mesh
- Extension tube: 250mm
- Packing: plastic bag with color label



STOCK NO.	DIAMETER	QTY./CARTON
65230	145mm	50

PP FUNNEL

- Upper diameter: 250mm / 10"
- Bottom diameter: 25mm / 1"
- Packing: plastic bag with color label



STOCK NO.	DIAMETER	QTY./CARTON
65232	250mm	48

4PCS FUNNEL SET

- Material: PP
- Packing: color label



STOCK NO.	DIAMETER	QTY./CARTON
65228	2", 3", 4", 5"	72

HAND PUMP

- Material: steel
- Packing: paper hanger



STOCK NO.	SIZE	QTY./CARTON
65501	Ø38x485mm	20

BICYCLE FLOOR PUMP

- Material: metal barrel
- Dimensions: Ø43x570mm
- Ergonomically designed comfortable handle
- Fits Presta, Schrader and Dunlop valve, free ball needle, and gas needle
- 80 PSI / 5.5 Bar high pressure capacity
- Packing: paper hanger with plastic bag



STOCK NO.	SIZE	QTY./CARTON
65503	Ø43x570mm	10

BICYCLE FLOOR PUMP WITH GAUGE

- Material: metal barrel
- Dimensions: Ø38x610mm
- Ergonomically designed comfortable Nylon handle
- Fits Presta, Schrader and Dunlop valve, free ball needle, and gas needle
- 120 PSI / 88 Bar high pressure capacity
- Packing: paper hanger with plastic bag



STOCK NO.	SIZE	QTY./CARTON
65505	Ø38x610mm	10

FOOT PUMP WITH GAUGE

- Dimensions: 2xØ55x120mm
- Metal double barrel
- Steel frame
- Unique design features foldable steel feet for added stability while pumping and long-lasting durability.
- Pumps up to 80 PSI.
- Fits Presta, Schrader and Dunlop valve, free ball needle, and gas needle
- Packing: color box



STOCK NO.	SIZE	QTY./CARTON
65510	2xØ55x120mm	10

POWER INFLATOR

- Input: DC 12V
- Max. Power: 120W
- Max. pressure: 100 PSI
- Air flow: 30L/min
- 77cm air hose
- 2.75m cigarette lighter cord with plug
- With LED light
- Three inflator adaptors
- Analog Gauge, Sole 30mm cylinder
- Fill a normal tire in 5-6 min
- Packing: color box



STOCK NO.	AIR FLOW	QTY./CARTON
65515	30L/min	6

POWER INFLATOR

- Input: DC 12V
- Max. Power: 200w
- Air flow: 40L/min
- 2x Cylinder diameter: 30mm
- Max. pressure: 100 PSI
- 77cm air hose
- 2.75m cigarette lighter cord with plug
- With LED light
- Three inflator adaptors
- Packing: color box



STOCK NO.	AIR FLOW	QTY./CARTON
65516	40L/min	6

HAND GREASE PUMP

- Barrel diameter: 220mm
- Height: 380mm
- Hose length: 1500mm
- Pressure: 3000psi
- Material of barrel: Steel
- Rubber handle
- Packing: carton box



STOCK NO.	CAPACITY	QTY./CARTON
65211	16KGS	1

PICK UP TOOL WITH CLAW

- Flexible shaft, chrome plated
- Size of claw: 1.5x0.6mm
- Max grabbing capacity: 750g
- Max grabbing diameter: 25mm
- Magnetic holding capacity: 4Lbs
- Two-component plastic handle
- Packing: paper hanger

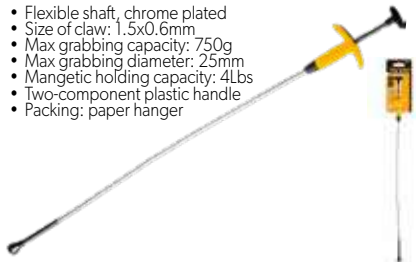

STOCK NO.	LENGTH	QTY./CARTON
66015	610mm, 41"	72

PICK UP TOOL WITH CLAW & LED LIGHT

- With LED light, 3xAG13/LR44
- Flexible shaft, black finished
- Size of claw: 1.5x0.6mm
- Max grabbing capacity: 750g
- Max grabbing diameter: 25mm
- Magnetic holding capacity: 2Lbs
- Aluminium handle, oxidation treatment
- Packing: paper hanger

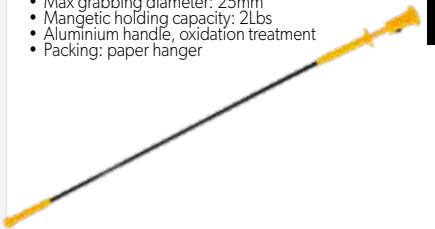

STOCK NO.	LENGTH	QTY./CARTON
66020	610mm, 41"	72

3-LED TELESCOPING PICK UP TOOL

- 3 ultra-bright LEDs
- 2 magnets at the ends of the Lamp
- Flexible neck 17.5-57cm
- Aluminium body
- 4 batteries LR44
- Three colors available
- Packing: display box with paper card



STOCK NO.	SIZE	QTY./CARTON
66011		48

MAGNETIC PART TRAY

- Stainless steel
- Rubber covered magnetic base
- Idea for storage of nuts, bolts, screws etc
- Packing: color box



STOCK NO.	SIZE	QTY./CARTON
66030	150mm, 6"	36

TELESCOPING PICK UP TOOL

- Magnetic power: 8Lbs
- Telescope from 5-1/2" to 28" (140-705mm)
- Stainless steel tube
- Packing: blister card



STOCK NO.	QTY./CARTON
66001	120

TELESCOPING PICK UP TOOL

- Magnetic power 5LBS
- Telescope from 5-1/2" to 25" (130-640mm)
- Stainless steel tube
- PVC dipped handle
- Packing: blister card



STOCK NO.	QTY./CARTON
66003	120

TELESCOPING PICK UP TOOL AND MIRROR SET

- 1pc telescoping pick up tool
- Magnetic power 5LBS
- With LED light, 3x1.5V LR44 batteries included
- Telescope from 245-800mm
- 1pc fixed shaft inspection mirror
- Diameter: 50mm
- Telescope from 240-700mm
- Stainless steel tube
- Bi-color dipped handle
- Packing: double blister



STOCK NO.	QTY./CARTON
66005	50

ENGINE CRANE

- Capacity: 2 Ton
- Lifting Range: 100-2350mm
- N.W. / G.W. : 80 / 83KG
- Package size 1: 143.5x31.5x16cm
- Package size 2: 83.5x58.5x9cm
- Folding size :550x810x1505mm
- Packing: carton box



STOCK NO.	CAPACITY	QTY./CARTON
67202	2 Ton	1

CHAIN BLOCK

- CE/GS approval
- Sealed roller bearing
- Packing: color box (1T, 2T, 3T) wooden box (5T)



Stock No.	Safe working load	Standard lift	Load chain fall	Dynamic load	Chainpull to lift full load	Load chain diameter	Qty./carton
62401	1 Ton	3m	1	15KN	250N	6x18mm	1
62402	2 Ton	3m	1	30KN	335N	8x24mm	1
62403	3 Ton	3m	2	45KN	265N	7.1x21mm	1
62404	5 Ton	3m	2	75KN	360N	9x27mm	1

CHAIN BLOCK

- CE approval
- Sealed roller bearing
- Packing: color box



STOCK NO.	Safe working load	Standard lift	Load chain fall	Chainpull to lift full load	Load chain diameter	QTY./CARTON
62411	1 Ton	3m	1	309N	6mm	1
62412	2 Ton	3m	2	314N	6mm	1
62413	3 Ton	3m	2	343N	8mm	1
62414	5 Ton	3m	2	383N	10mm	1

ELECTRIC HOIST

- CE approval
- Input power: 800W
- Rated Voltage: 230V
- Frequency: 50Hz
- Lifting weight: 250Kg(Single-hook) 500Kg(Double-hook)
- Lifting height: 12m, 6m
- Lifting speed: 8m/min, 4m/min
- Upper and lower limit device
- Emergency stop switch
- Thermal protection terminal
- Packing: color box

**250kg/
500kg**



INDUSTRIAL



STOCK NO.	LIFTING WEIGHT	QTY./CARTON
62491	250kg/500kg	2

ELECTRIC HOIST

- CE approval
- Input power: 1600W
- Rated Voltage: 230V
- Frequency: 50Hz
- Lifting weight: 500Kg(Single-hook) 999Kg(Double-hook)
- Lifting height: 12m, 6m
- Lifting speed: 8m/min, 4m/min
- Upper and lower limit device
- Emergency stop switch
- Thermal protection terminal
- Packing: color box

**500kg/
999kg**



INDUSTRIAL



STOCK NO.	LIFTING WEIGHT	QTY./CARTON
62492	500kg/999kg	1

BOTTLE JACK

- GS approved
- 2 times longer life
- Leak proof welded construction
- Steel plate instead of cast iron for environment protection
- Preventing from oil leakage
- Oil remaining clear after using
- Packing: color box

PRODUCT UPDATE

INDUSTRIAL



65421
65422



STOCK NO.	CAPACITY	MIN. HEIGHT	LIFT HEIGHT	ADJUSTABLE HEIGHT	NET WEIGHT	QTY./ CARTON
65402	2 Tons	168 mm	100 mm	48 mm	2kgs	6
65404	4 Tons	188 mm	115mm	60mm	2.8kgs	6
65406	6 Tons	207mm	125mm	70mm	3.7kgs	4
65410	10 Tons	222mm	145mm	80mm	4.8kgs	4
65420	20 Tons	235mm	150mm	60mm	8.6kgs	2
65421	32 Tons	260mm	160mm		17.8kgs	1
65422	50 Tons	280mm	170mm		25.8kgs	1

SLOWLY DOWN
SLOW DESCENDING WITH LOAD



2x LONGER LIFE

TOUGH ENOUGH
TO GET THE JOB DONE



HYDRAULIC TROLLEY JACK

- GS approved
- Heavy duty
- Fast lifting dual pump
- Packing: color box

INDUSTRIAL



STOCK NO.	CAPACITY	MIN. HEIGHT	MAX. HEIGHT	NET WEIGHT	QTY./ CARTON
65464	3 Tons	130 mm	465mm	29.3kgs	1

FAST LIFTING DUAL PUMP

HYDRAULIC BOTTLE JACK

- Thread adjustment height: 60mm
- Fitted with unique overload protection system
- Large stable base and notched saddle
- Supplied with two-piece handle
- Packing: color box



STOCK NO.	CAPACITY	MIN HEIGHT	LIFT HEIGHT	LIFTING RANGE	NET WEIGHT	QTY./ CARTON
65425	2 Tons	158mm	90mm	158-308mm	2.3kg	6
65427	4 Tons	195mm	125mm	195-380mm	3.0kg	6
65429	6 Tons	197mm	125mm	197-382mm	4.0kg	4
65431	10 Tons	205mm	125mm	205-390mm	5.7kg	2
65432	12 Tons	215mm	135mm	215-400mm	6.8kg	2
65433	20Tons	255mm	145mm	244-449mm	10.3kg	2

HYDRAULIC TROLLEY JACK

- GS approved
- Packing: color box



65462

65463

STOCK NO.	CAPACITY	MIN HEIGHT	MAX HEIGHT	NET WEIGHT	QTY./ CARTON
65462	2 Tons	135 mm	330 mm	8.8kgs	1
65463	3 Tons	135 mm	400 mm	16.4kgs	1

JACK STANDS

- GS approved
- Ratchet style allows for fine adjustment and fast remove
- Solid steel handle, self-locking ratchet
- Large saddle, unitized frame construction
- Ductile iron rack
- Packing: color box



STOCK NO.	CAPACITY	MIN HEIGHT	MAX HEIGHT	NET WEIGHT	QTY./ CARTON
65482	2 Tons	268 mm	418 mm	5.1kgs	2 Pairs
65483	3 Tons	276mm	420mm	6.6kgs	2 Pairs
65484	6 Tons	382mm	600mm	13.5kgs	1 Pair

HAND CABLE PULLER

- CE approved
- Double gear & double hooks with zinc plated
- Soft rubber handle
- Packing: color box



STOCK NO.	CAPACITY	CABLE SIZE	QTY./CARTON
62442	2 Tons	5.0mm x 3M	6

HAND WINCH

- CE approval
- One piece forged gear with fine and durable performance
- Mainly used for horizontal towing
- Widely applied on industrial and agricultural fields
- Packing: color box



STOCK NO.	CAPACITY	CABLE SIZE	QTY./CARTON
62451	800 Lbs	4.0mmx10M	6
62452	1200 Lbs	4.0mmx10M	6
62453	2000 Lbs	5.0mmx10M	4

PNEUMATIC ROLLER SEAT

- 5 pcs swivel casters for easy movement
- Heavy duty steel frame
- Well padded seat
- With handy tool tray
- Easy adjustable seat height (120mm range)
- Caster size: 2.5 inch
- Powder coat finish
- Packing: color box



150kgs
330LBS

Ø300 mm

380-510 mm
15"-20"
EASY ADJUSTABLE SEAT HEIGHT

STOCK NO.	WEIGHT CAPACITY	QTY./CARTON
65495	150kgs / 330LBS	1

BOOSTER CABLE

- GS approved
- 16mm², 220A
- Packing: PVC bag



STOCK NO.	SIZE	QTY./CARTON
65601	3M	10

BATTERY CHARGER

- safe and reliable electronic circuit design
- small size, light weight, high efficiency, convenient carrying and simple use.
- It is suitable for charging the batteries of motorcycles, battery cars, tractors, small cars and buses, engineering vehicles, transport vehicles, sailboats and yachts etc...
- Charging various 12V or 24V lead-acid batteries
- Fast charging function for 12V batteries
- pointer-type current displays dynamic currents during charging, visible real-time charging current makes it more accurate and faster
- Double humidity control and two fuses, providing safety protection

NEW
230VAC INPUT **12/24VDC OUTPUT**



STOCK NO.	INPUT	OUTPUT	QTY./CARTON
79997	230VAC	12/24V 9/4A	2



WELDING GLOVES

- Material: cow split leather
- Lengthened for better protection
- Packed by paper hanger



STOCK NO.	SIZE	QTY./CARTON
45025	14	72

WELDING GLOVES

- Material: Cow split leather
- Lengthened for better protection
- With half lining
- Packed by paper hanger



STOCK NO.	SIZE	QTY./CARTON
45026	14	48

INVERTER MMA DC WELDING MACHINE

- IGBT Inverter technology
- Input voltage(V):220AC
- Frequency(Hz):50/60
- Accessories:
1pc electrode holder with cable
1pc earth clamp with cable
1pc welding brush
1pc welding mask
- Packing: color box



STOCK NO.	Rated input capacity (KVA)	No load voltage (V)	Output current (A)	Max output current (A)	Duty cycle (40°C)	Electrode size (mm)	QTY./CARTON
44002	8.5	100	30-160	160	160A @ 35%	ø1.6 - 4.0	1
44004	10.8	103	30-200	200	200A @ 25%	ø1.6 - 5.0	1

INVERTER MMA DC WELDING MACHINE

NEW 110V/220V ~50/60Hz

- IGBT Inverter technology
- Input voltage: 110V / 220V
- Frequency: 50/60Hz
- Rated input capacity:3.52KVA/7.04KVA
- No load voltage: 88V
- Output current: 20-90A/20-140A
- Duty cycle: 40% /25% (40°C)
- Electrode size: ø1.6-4.0mm
- Accessories
1pc electrode holder with cable
1pc earth clamp with cable
1pc wire brush
1pc helmet
- Packing: color box



STOCK NO.	Rated input capacity (KVA)	No load voltage (V)	Output current (A)	Max output current (A)	Duty cycle (40°C)	Electrode size (mm)	QTY./CARTON
44031	3.52/7.04	88	20-90/20-140	160	45%/25%	ø1.6- 4.0	1

AUTOMATIC WELDING MASK

- CE approved
- Light state: DIN.4
- Dark state: DIN.9-13
- Switching time(s): 1/25000
- Delay time: 0.2-0.8s continue adjustable
- Power supply: Solar cells & lithium batteries
- Power on/off: Fully automatic
- Shade knob: Out
- Sensitivity: Adjustable
- Suitable for ARC, TIG, MIG, Spot, Micro, Wire, AC, DC, and Plasma Welders and Plasma Cutters
- Packing: color box



STOCK NO.	FILTER SIZE	VIEWING SIZE	QTY./CARTON
45087	110x90x10mm	92X42mm	4



HELPING HAND MAGNIFIER

- Diameter of glass lens: 62mm / 1-1/2"
- A useful aid for soldering work or model makers.
- Adjustable crocodile holding clamps.
- Bottom compartment is furnish with steel plate which can enhance stability.
- Useful for soldering work, watches, computer repair, jewelry making or any other type of precision work.
- Packing: color box



STOCK NO.	GLASS SIZE	QTY./CARTON
38090	62mm / 1-1/2"	24

WELDING MASK

- Impacted resistant shell
- Packing: polybag with color sticker



STOCK NO.	GLASS SIZE	QTY./CARTON
45085	108x50x3mm	50

WELDING MASK

- Impacted resistant shell
- Anti wear
- Moveable type glass
- Packing: polybag with color sticker



STOCK NO.	GLASS SIZE	QTY./CARTON
45086	108x50x3mm	25

WELDING GOGGLE

- Flip design with open-close locking position
- Soft and light weight PVC frame
- Colored inorganic outer glass lens
- Transparent clear inner glass lens
- Packing: polybag with paper hanger



STOCK NO.	QTY./CARTON
45075	100

ELECTRODE HOLDER

- Material: Upper iron, Lower brass
- Electrodes through:
44930 5/64"-1/4" (2.0-6.35mm)
44931 3/32"-3/8" (2.5-9.5mm)
- Packing: color box



STOCK NO.	LENGTH	AMP CAPACITY	QTY./CARTON
44928	250mm	300A	25
44929	260mm	500A	25

ELECTRODE HOLDER

- CE approved
- Material: Upper iron, Lower brass
- Packing: color box



STOCK NO.	LENGTH	AMP CAPACITY	QTY./CARTON
44935	250mm	500A	25
44936	270mm	800A	25

EARTH CLAMP

- Material of the handle: Chrome-plated iron
- Gripper material: Brass
- Packing: color box



STOCK NO.	GRIPPER LENGTH	GRIPPER THICKNESS	CURRENT	QTY./CARTON
44940	170mm	0.7mm	300A	60
44941	210mm	0.8mm	500A	40

WELDING ELECTRODE

- E6013
- For welding normal carbon steel structure
- 5kgs Packing: one box



STOCK NO.	SIZE	KGS/CARTON
44952	2.5x300mm	20kgs
44953	3.2x350mm	20kgs

WELDING ELECTRODE

- E7018
- Excellent for welding carbon and low alloy steel structure
- 5kgs Packing: one box



STOCK NO.	SIZE	KGS/CARTON
44963	3.2x350mm	20kgs

MAGNETIC WELDING HOLDER

- For holding workpieces when soldering or welding
- Working angles: 45°, 90°, 135°
- Manufactured from high quality pressed steel with strong magnet
- Packing: double blister



STOCK NO.	SIZE	KGS/CARTON
44910	25 LBS	48
44911	50 LBS	30
44912	75 LBS	18

TOLSEN **FX** FORCE XPRESS

UNLEASH THE POWER WITHIN





ELECTRIC DRILL

- Rated Voltage: 230V
- Frequency: 50Hz
- No load speed: 0-3800/min
- Chuck: Ø0.8-10mm
- Max. in wood: 20mm
- Max. in steel: 10mm
- Packing: color box

400W 10mm



STOCK NO.	SIZE	QTY./CARTON
79500	400W/10mm	6
79500-BS	400W/10mm	6

HAMMER DRILL

- CE approved
- Rated Voltage: 220-240V
- Frequency: 50/60Hz
- No load speed: 0-2900/min
- With drill / hammer switch
- Impact frequency: 0-46400bpm
- Chuck: Ø13mm
- Max. in steel: 13mm
- Max. in concrete: 13mm
- Max. in wood: 25mm
- Plug & cable: VDE approved
- Accessories:
 - 1pc side handle
 - 1pc 13mm key chuck
 - 1pc depth gauge (plastic)
- Packing: color box

710W 500W 13mm

2FUNCTIONS

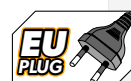

STOCK NO.	SIZE	QTY./CARTON
79501A	500W/13mm	6
79502A	710W/13mm	6

HAMMER DRILL

- CE approved
- Rated Voltage: 230-240V
- Frequency: 50/60Hz
- Input power: 850W
- No load speed: 0-2900/min
- With drill / hammer switch
- Impact frequency: 0-46400bpm
- Chuck: Ø13mm
- Max. in steel: 13mm
- Max. in concrete: 16mm
- Max. in wood: 25mm
- Plug & cable :VDE approved
- Accessories:
 - 1pc side handle
 - 1pc 13mm key chuck
 - 1pc depth gauge (plastic)
- Packing: color box

850W 13mm

2FUNCTIONS



STOCK NO.	SIZE	QTY./CARTON
79503A	850W/13mm	6

HAMMER DRILL

- CE approval
- Input power: 650W
- Rated Voltage: 230-240V
- Frequency: 50/60Hz
- No Load Speed: 0-3000r/min
- Impact Frequency: 0-48000bpm
- With impact function switch
- chuck capacity Ø : 13mm
- Max in steel: 13mm
- Max in concrete: 13mm
- Max in wood: 25mm
- Plug & cable : VDE approved 2m
- Accessories contain
- 1pc side handle
- 1pc 13mm KEY CHUCK
- 1pc depth guage(plastic)
- Packing: colox box

INDUSTRIAL



650W

13mm

2 FUNCTIONS



STOCK NO.	SIZE	QTY./CARTON
79504	650W/13mm	8

HAMMER DRILL

- CE approval
- Rated Voltage: 230-240V
- Frequency: 50/60Hz
- No Load Speed: 0-3000/min
- Impact Frequency: 0-48000bpm
- With impact function switch
- chuck capacity Ø : 13mm
- Max in steel: 13mm
- Max in concrete: 13mm
- Max in wood: 25mm
- Plug & cable : VDE approved 2m
- Accessories contain
- 1pc side handle
- 1pc 13mm KEY CHUCK
- 1pc depth guage(plastic)
- Packing: colox box

INDUSTRIAL



750W

850W

13mm

2 FUNCTIONS

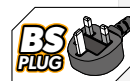
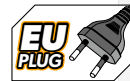

STOCK NO.	SIZE	QTY./CARTON
79505	750W/13mm	8
79505-BS	750W/13mm	8
79506	850W/13mm	8
79506-BS	850W/13mm	8

HAMMER DRILL AUTOMATIC CHUCK

- CE approval
- Rated Voltage: 230-240V
- Frequency: 50/60Hz
- No Load Speed: 0-3000/min
- Impact Frequency: 0-48000bpm
- With impact function switch
- chuck capacity Ø : 13mm
- Max in steel: 13mm
- Max in concrete: 13mm
- Max in wood: 25mm
- Plug & cable : VDE approved 2m
- Accessories contain
- 1pc side handle
- 1pc 13mm KEY CHUCK
- 1pc depth guage(plastic)
- Packing: colox box



750W

850W

13mm

2 FUNCTIONS



STOCK NO.	SIZE	QTY./CARTON
79505A	750W/13mm	8
79505A-BS	750W/13mm	8
79506A	850W/13mm	8
79506A-BS	850W/13mm	8

KEY CHUCK

- Packing: color box



STOCK NO.	CHUCK CAPACITY	CONNECTION SIZE	QTY./CARTON
79160	1.5-10mm	3/8"-24UNF	50
79161	1.5-13mm	1/2"-20UNF	40

KEYLESS DRILL CHUCK

- Packing: color box



STOCK NO.	CHUCK CAPACITY	CONNECTION SIZE	QTY./CARTON
79170	0.8-10mm	3/8"-24UNF	50
79171	2-13mm	1/2"-20UNF	40

CHUCK KEY

- Packing: double blister



STOCK NO.	SIZE	QTY./CARTON
79180	10mm	100
79181	13mm	100
79182	16mm	80

DRILL STAND

- For use with drills
- Sturdy base with slots for fitting machine vice
- Suitable for TOLSEN hammer drill 79501/79501A/79502/79502A/79503/79503A/79505/79505A/79506/79506A/79505-BS/79505A-BS/79506-BS/79506A-BS
- Column height: 510mm
- Column diameter: 25mm
- Depth of feed: 60mm
- Collar diameter: 43mm and 38mm
- Base size: 22x16cm
- Net weight: 3kg
- Aluminum die casting body
- Packing: color box



STOCK NO.	SIZE	QTY./CARTON
10500	43mm	4

ROTARY HAMMER

- CE approval
- Input power: 800W
- Rated Voltage: 220-240V
- Frequency: 50Hz
- No load speed: 0-1200/min
- Impact rate: 0-5500bpm
- Impact energy: 2.8J
- Drilling capacity:
 - Steel: 13mm
 - Concrete: 26mm
 - Wood: 40mm
- SDS plus chuck
- Plug & cable : VDE approved 2m
- Accessories contain
 - 1pc point chisel: 13x240mm
 - 1pc flat chisel: 13x240mm
 - 3pcs SDS-plus drill bits: 6x140mm, 8x140mm, 110x140mm
 - 1pc auxiliary handle
 - 1pc depth gauge
- Packing: BMC with color sleeve



800W SDS-PLUS
26mm

3 FUNCTIONS \cong $T \equiv T$

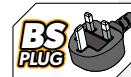
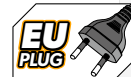

STOCK NO.	SIZE	QTY./CARTON
79510	800W/26mm	4
79510-BS	800W/26mm	4

ROTARY HAMMER

- CE approval
- Input power: 1100W
- Rated Voltage: 230V
- Frequency: 50Hz
- No load speed: 770/min
- Impact rate: 4200bpm
- Impact energy: 4.5J
- Drilling capacity:
 - Steel: 13mm
 - Concrete: 28mm
 - Wood: 45mm
- SDS plus chuck
- Plug & cable : VDE approved 2m
- Accessories contain
 - 1pc point chisel: 14x250mm
 - 1pc flat chisel: 14x250mm
 - 3pcs SDS-plus drill bits: 8x150mm, 10x150mm, 12x150mm
 - 1 pair Carbon brush
 - 1pc dust cover
 - 1 bottle lubricating oil
 - 1pc wrench
 - 1pc instruction manual
- Packing: BMC with color sleeve



1100W SDS-PLUS
28mm

3 FUNCTIONS \cong $T \equiv T$



STOCK NO.	SIZE	QTY./CARTON
88530	1100W/28mm	3
88530-BS	1100W/28mm	3

ROTARY HAMMER

- CE approval
- Input power: 1500W
- Rated Voltage: 230V
- Frequency: 50Hz
- No load speed: 780/min
- Impact rate: 4300bpm
- Impact energy: 5.5J
- Drilling capacity:
- Steel: 13mm
- Concrete: 32mm
- Wood: 50mm
- SDS plus chuck
- Plug & cable : VDE approved 2m
- Accessories contain
- 1pc point chisel: 14x250mm
- 1pc flat chisel: 14x250mm
- 3pcs SDS-plus drill bits: 8x150mm, 10x150mm, 12x150mm
- 1 pair Carbon brush
- 1pc dust cover
- 1 bottle lubricating oil
- 1pc wrench
- Packing: BMC with color sleeve

INDUSTRIAL



1500W SDS-PLUS
32mm

3 FUNCTIONS | T | T

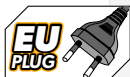

STOCK NO.	SIZE	QTY./CARTON
88531	1500W/32mm	3
85531-BS	1500W/32mm	3

ROTARY HAMMER

- CE approval
- Input power: 1250W
- Rated Voltage: 220-240V
- Frequency: 50-60HZ
- No load speed: 0-480/min
- Impact rate: 1500-3100bpm
- Impact energy: 1-9.0J
- SDS MAX chuck
- Concrete: 40mm
- Plug & cable: VDE approved 2m
- Net weight: 6.5kg
- Accessories contain
- 1pc point chisel: 18x320mm
- 1pc flat chisel: 18x320mm
- 1pc grease pot
- 1pc dust protection
- 1 pair Carbon brush
- 1 bottle lubricating oil
- 1 pc wrench
- Packing: BMC with color sleeve

INDUSTRIAL



1250W SDS-MAX
40mm

2 FUNCTIONS | T

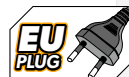

STOCK NO.	SIZE	QTY./CARTON
88540	1250W/40mm	2

DEMOLITION HAMMER
HEX CHUCK

- CE approval
- Input power: 1050W
- Rated Voltage: 230V
- Frequency: 50HZ
- Impact rate: 4000bpm
- Impact force: 10J
- Net weight: 6kg
- HEX chuck system
- Lock-off switch
- Heat insulation
- Plug & cable : VDE approved 2m
- Accessories contain
- 1pc auxiliary handle
- 1pc point chisel: 18x280mm
- 1pc flat chisel: 22x18x280mm
- 1 pair Carbon brush
- 1 pc wrench
- Packing: BMC with color sleeve

INDUSTRIAL



1050W HEX



STOCK NO.	SIZE	QTY./CARTON
88550	1050W	2
88550-BS	1050W	2

DEMOLITION HAMMER SDS-MAX CHUCK

- CE approval
- Input power: 1500W
- Rated Voltage: 230V
- Frequency: 50HZ
- Impact rate: 900-2100bpm
- Impact force: 15-45J
- Net weight: 11kg
- SDS-MAX chuck system
- Lock-off switch
- Quick reversing function
- Plug & cable : VDE approved 4m
- Accessories contain:
 - 1pc auxiliary handle
 - 1pc point chisel: 18x280mm
 - 1pc flat chisel: 22x18x280mm
 - 1 pair Carbon brush
 - 1pc hex key
- Packing: BMC with color sleeve

INDUSTRIAL

DEMOLITION HAMMER HEX CHUCK

- CE approval
- Input power: 1600W
- Voltage: 230V
- Frequency: 50Hz
- Impact rate: 1850bpm
- Impact force: 60J
- HEX chuck system
- Net weight: 16kgs
- Plug & cable : VDE approved 4m
- Accessories contain:
 - 1pc point chisel: 30x410mm
 - 1pc flat chisel: 30x410mm
 - 1 pair Carbon brush
 - 1 bottle lubricating oil
 - 1pc wrench
 - 2pcs hex keys
- Packing: High quality BMC box with wheels

INDUSTRIAL

HEAVY-DUTY DEMOLITION HAMMER

- CE approved
- Input power: 1700W
- Voltage: 230V
- Frequency: 50Hz
- Impact rate: 1650bpm
- Impact force: 60J
- HEX chuck system
- Net weight: 18kgs
- Plug & cable : VDE approved 4m
- Accessories contain:
 - 1pc point chisel: 30x410mm
 - 1pc flat chisel: 30x410mm
 - 1 pair Carbon brush
 - 1pc wrench
 - 2pcs hex keys
- Packing: High quality BMC box with wheels

INDUSTRIAL

1500W SDS-MAX

1600W HEX

1700W GREASE LUBRICATION HEX

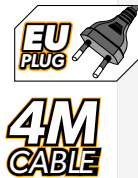

STOCK NO.	SIZE	QTY./CARTON
88551	1500W	1

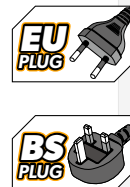
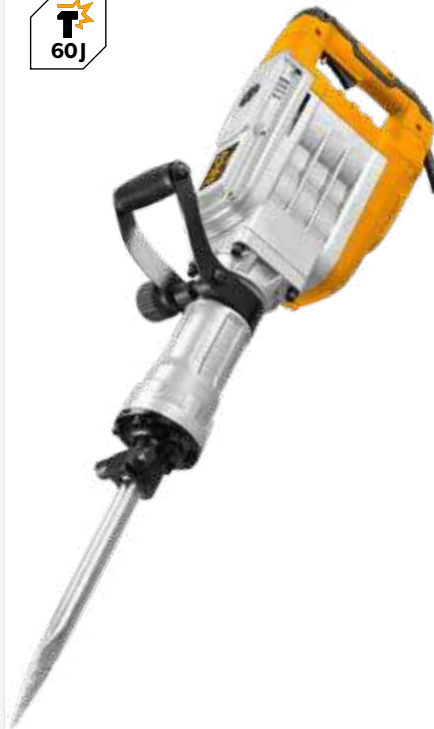

STOCK NO.	SIZE	QTY./CARTON
88552	1600W	1
88552-BS	1600W	1

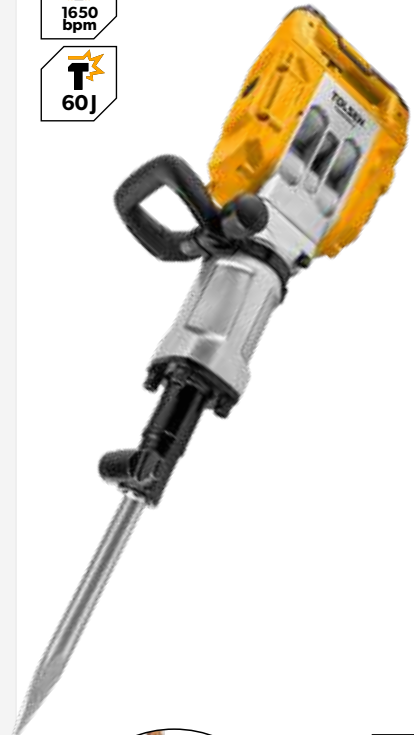

STOCK NO.	SIZE	QTY./CARTON
88553	1700W	1

ANGLE GRINDER

- Input power: 760W
- Voltage: 230V
- Frequency: 50Hz
- No load speed: 11000/min
- Disc diameter: 100mm
- Spindle thread: M10
- Accessories contain:
 - 1pc wheel guard
 - 1 pair Carbon brush
 - 1pc side handle
 - 1pc wrench
- Packing: color box

760W
100mm



M10

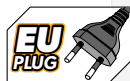

STOCK NO.	SIZE	QTY./CARTON
79542	760W/100mm	8

ANGLE GRINDER

- Input power: 760W
- Voltage: 230V
- Frequency: 50Hz
- No load speed: 11000/min
- Disc diameter: 115mm
- Spindle thread: M14
- Accessories contain:
 - 1pc wheel guard
 - 1 pair Carbon brush
 - 1pc side handle
 - 1pc wrench
- Packing: color box

760W
115mm



M14

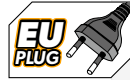

STOCK NO.	SIZE	QTY./CARTON
79543	760W/115mm	8

INDUSTRIAL J

ANGLE GRINDER

- Voltage: 230V
- Frequency: 50Hz
- No load speed: 12000/min
- Disc diameter: 100mm
- Spindle thread: M10
- Accessories:
 - 1 pair carbon brush
 - 1pc side handle
 - 1pc wrench
 - 1pc wheel guard
- Packing: color box

850W
100mm



M10



STOCK NO.	SIZE	QTY./CARTON
79519	850W/100mm	6

ANGLE GRINDER

- Voltage: 230V
- Frequency: 50Hz
- No load speed: 12000/min
- Disc diameter: 115mm
- Spindle thread: M14
- Accessories:
 - 1 pair carbon brush
 - 1pc side handle
 - 1pc wrench
 - 1pc wheel guard
- Packing: color box

850W
115mm



M14



STOCK NO.	SIZE	QTY./CARTON
79520	850W/115mm	6

INDUSTRIAL J

INDUSTRIAL J

ANGLE GRINDER

- CE approval
- Input power: 1200W
- Voltage: 230V
- Frequency: 50Hz
- No load speed: 3000-11500/min
- Disc diameter: 125mm
- Spindle thread: M14
- Self-lock-preventing switch
- Plug & cable: CE approved 2m
- Accessories contain:
 - 1 pair Carbon brush
 - 1pc auxiliary handle
 - 1pc wrench
 - 1pc hex key
- Packing: color box

INDUSTRIAL



1200W 125mm



M14

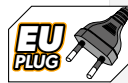

STOCK NO.	SIZE	QTY./CARTON
79527	1200W/125mm	2

ANGLE GRINDER

- CE approval
- Input power: 950W
- Voltage: 230V
- Frequency: 50Hz
- No load speed: 9500/min
- Disc diameter: 125mm
- Spindle thread: M14
- Plug & cable: CE approved 2m
- Power-off protection
- Accessories contain:
 - 1 pair Carbon brush
 - 1pc auxiliary handle
 - 1pc wrench
- Packing: color box

INDUSTRIAL



950W 125mm



M14

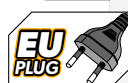

STOCK NO.	SIZE	QTY./CARTON
88580	950W/125mm	8
88580-BS	950W/125mm	8

ANGLE GRINDER

- CE approval
- Input power: 2100W
- Voltage: 220-230V
- Frequency: 50Hz
- No load speed: 8000/min
- Disc diameter: 180mm
- Spindle thread: M14
- Self-lock-preventing switch
- Soft starter
- Plug & cable: CE approved 2m
- Accessories:
 - 1 pair carbon brush
 - 1pc side handle
 - 1pc wrench
 - 1pc wheel guard
 - 1pc hex key 6mm
- Packing: color box



2100W 180mm



M14



STOCK NO.	SIZE	QTY./CARTON
79523	2100W/180mm	2

ANGLE GRINDER

- CE approval
- Input power: 2350W
- Voltage: 230V
- Frequency: 50Hz
- No load speed: 6000/min
- Disc diameter: 230mm
- Spindle thread: M14
- Self-lock-preventing switch
- Soft starter
- Plug & cable: CE approved 2m
- Accessories:
 - 1 pair carbon brush
 - 1pc side handle
 - 1pc wrench
 - 1pc wheel guard
 - 1pc hex key 6mm
- Packing: color box



2350W 230mm



M14

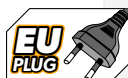

STOCK NO.	SIZE	QTY./CARTON
79524	2350W/230mm	2

ANGLE GRINDER

- CE approved
- Input Power: 2400W
- Rated Voltage: 220-230V
- Frequency: 50Hz
- Disc Diameter: 230mm
- Spindle thread: M14
- No Load Speed: 6000/min
- Soft start
- Plug & cable: CE approved 2m
- Reverse self-locking
- Accessories:
- 1 pair carbon brush
- 1pc side handle
- 1pc wrench
- 1pc wheel guard
- Packing: color box

INDUSTRIAL



2400W 230mm



M14

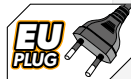

STOCK NO.	SIZE	QTY./CARTON
79525	2400W/230mm	2
79525-BS	2400W/230mm	2



ANGLE GRINDER

- Input power: 3000W
- Voltage: 230V
- Frequency: 50Hz
- No load speed: 6600/min
- Disc diameter: 230mm
- Spindle thread: M14
- Self-lock-preventing switch
- Plug & cable: CE approved 2m
- Accessories contain:
- 1 pair Carbon brush
- 1pc side handle
- 1pc wrench
- 1pc hex key 6mm
- Packing: color box

INDUSTRIAL

M14

3000W 230mm



STOCK NO.	SIZE	QTY./CARTON
79526	3000W/230mm	2



ANGLE GRINDER STAND

- For use with 115mm / 125mm angle grinders.
- Suitable for TOLSEN angle grinders 79520/79543/79521/88580/88580-BS/79527/79542/79519
- Overall size: 240x190x290mm
- Base size: 240x190mm
- Net weight: 2.6kg
- Aluminum die casting body
- The clamping Angle can be adjusted from 0-45°
- Packing: color box

115/125mm



STOCK NO.	SIZE	QTY./CARTON
10501	115/125mm	4

ANGLE GRINDER STAND

- For use with 180mm / 230mm angle grinders.
- Suitable for TOLSEN angle grinders 79523/79524/79524-BS/79525/79525-BS/79526
- Overall size: 300x300x355mm
- Base size: 300x300mm
- Net weight: 3.1kg
- Aluminum die casting body
- The clamping Angle can be adjusted from 0-45°
- Packing: color box

180/230mm



STOCK NO.	SIZE	QTY./CARTON
10502	180/230mm	4

PALM DETAIL SANDER

- CE approved
- Voltage: 230-240V
- Frequency: 50Hz
- Orbital frequency: 12000/min
- Pad size: 140x140x90mm
- Accessories:
 - 3pcs sanding papers
 - 1pc dust box
- Packing: color box

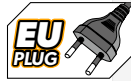

NEW

200W



STOCK NO.	SIZE	QTY./CARTON
79562	200W	6

1/3 SHEET FINISHING SANDER

- CE approved
- Voltage: 230V
- Frequency: 50Hz
- Orbital frequency: 6000-12000/min
- Pad size: 187x92.5mm
- Accessories:
 - 3pcs sanding papers
 - 1pc dust box
- Packing: color box

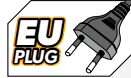

NEW

220W



STOCK NO.	SIZE	QTY./CARTON
79564	220W	6

RANDOM ORBITAL SANDER

- CE approved
- Voltage: 230V
- Frequency: 50Hz
- Orbital frequency: 6000-13000/min
- Pad size: Ø125mm
- Orbital diameter: 127mm
- Accessories:
 - 3pcs sanding paper
 - 1pc dust box
- Packing: color box

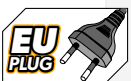

NEW

280W

Ø125mm



STOCK NO.	SIZE	QTY./CARTON
79566	280W	6

DRYWALL SANDER

- CE approval
- Input power: 900W
- Rated Voltage: 230-240V
- Frequency: 50Hz
- No-load speed: 1400-2700/min
- Diameter of sanding disc: 180mm
- Diameter of grinding pad: 175mm
- Length of cable: 3.5m
- Soft start control
- Self-suction function
- Variable control
- With LED work light
- 1pc side handle
- 1pc dust bag
- 6pcs sanding discs (2pcs 120grits, 2pcs 180grits, 2pcs 240grits)
- 1pc flexible tube 2m
- 1pc connection adaptor
- Packing: color box

INDUSTRIAL

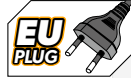

NEW

900W

Ø180mm

LED WORK LIGHT



STOCK NO.	SIZE	QTY./CARTON
79584	900W	4

DRYWALL SANDER

- CE approval
- Input power: 880W
- Rated Voltage: 230-240V
- Frequency: 50Hz
- No-load speed: 1000-2100/min
- Diameter of sanding disc: 225mm
- Diameter of grinding pad: 215mm
- Length of cable: 4.5m
- Telescopic shaft: 1.5m - 2.2m
- Soft start control
- Self-uncion function
- Variable control
- With LED work light
- 1pc dust bag
- 6pcs sanding discs (2pcs 120grits, 2pcs 180grits, 2pcs 240grits)
- 1pc flexible tube 2m
- 1pc connection adaptor
- Packing: color box

INDUSTRIAL



880W Ø225mm



LED WORK LIGHT



STOCK NO.	SIZE	QTY./CARTON
79585	880W	1

ANGLE POLISHER

- CE approval
- Input power: 1400W
- Rated Voltage: 230-240V
- Frequency: 50/60Hz
- No load speed: 800-3300/min, Variable speed
- Polishing pad diameter: 180mm
- M14 spindle thread
- Durable aluminum gear box
- with 1pc polishing pad
- 1pc wool bonnet
- 1pc D type handle
- 1 pair carbon brush
- Packing: color box



1400W

NEW



M14

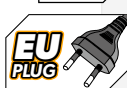

STOCK NO.	SIZE	QTY./CARTON
88598	1400W	4



ELECTRIC ROUTER

- CE approval
- Input power: 2100W
- Rated Voltage: 220-240V
- Frequency: 50/60Hz
- No load speed: 8000-23500/min, variable speed
- Plunge depth: 0-55mm
- Collet size: 5/16", 8mm, 12mm, 1/2"
- Aluminium plane floor
- With 1pc aluminum guide fence
- With 1set paralle guide
- With 1set carbon brushes
- With 1pc dust bag connector
- Packing: color box



2100W



5/16" 8mm 12mm 1/2"



STOCK NO.	SIZE	QTY./CARTON
79534	2100W	2

LAMINATE TRIMMER

- CE approval
- Input power: 500W
- Rated Voltage: 220-240V
- Frequency: 50/60Hz
- No load speed: 33500/min
- Chuck diameter: 1/4" and 6mm
- Graduated scale for adjusting depth of trimming
- Transparent plastic base for clear view of trimming edge
- 1pc guide fence
- 1pc template guide
- Packing: color box

500W

1/4" 6mm

NEW

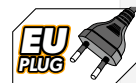

STOCK NO.	SIZE	QTY./CARTON
79539	500W/1/4" 6mm	10

INDUSTRIAL

BELT SANDER

- CE approval
- Input power: 810W
- Rated Voltage: 230V
- Frequency: 50Hz
- Belt size: 533x76mm
- No load speed: 200-380/min
- Accessories:
 - 1pc sand paper
 - 1pc plastic belt
 - 1pc dust bag
- Packing: color box



810W



STOCK NO.	SIZE	QTY./CARTON
79568	810W	6
79568-BS	810W	6

ELECTRIC PLANER

- CE approval
- Input power: 900W
- Rated Voltage: 230-240V
- Frequency: 50Hz
- No-load speed: 16000/min
- Planing width: 82mm
- Planing depth: 0-3mm
- Heavy duty aluminum base
- Accessories:
 - 2pcs planing blades
 - 1pc belt
 - 1set parallel guide
 - 1pc depth guide
- Packing: color box



900W 82mm

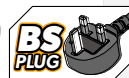
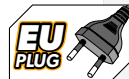

STOCK NO.	SIZE	QTY./CARTON
79535	900W/82mm	6
79535-BS	900W/82mm	6

CIRCULAR SAW

- CE approval
- Input power: 1300W
- Rated Voltage: 230-240V
- Frequency: 50Hz
- No Load Speed: 5000/min
- Switch: with lock-off switch
- Blade diameter: 185mm(7-1/4")
- Max. cutting depth: 65mm @90° / 44mm @45°
- Plug & cable : VDE approved 2m
- Aluminium diecast guard
- 45°-90° bevelling range
- Accessories:
 - 1pc hex key wrench
 - 1pc TCT saw blade for wood working
 - 1pc parallel guide
- Packing: color box



1300W

185mm

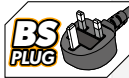
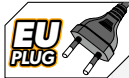

STOCK NO.	SIZE	QTY./CARTON
79532	1300W/185mm	4
79532-BS	1300W/185mm	4

MARBLE CUTTER

- Input power: 1450W
- Rated Voltage: 220-230V
- Frequency: 50/60Hz
- No-load speed: 13000/min
- Disc diameter: 125mm
- Spindle thread: 20mm
- Max. cutting depth: 39mm
- Adjustable cutting depth
- Accessories contains:
 - 1pc wrench for shaft lock
 - 1pc plate wrench
 - 1pair carbon brush
 - 1pc water hose 1meter
 - 1pc faucet
 - 1pc connector
- Packing: color box

1450W

125mm

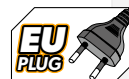

STOCK NO.	SIZE	QTY./CARTON
79533	1450W/125mm	4

WALL CHASER

- CE approval
- Input power: 1500W
- Rated Voltage: 230-240V
- Frequency: 50HZ
- No-load speed: 8500/min
- Disc diameter: 125mm
- Spindle thread: M14
- Cutting depth: 5-29 mm
- Cutting width: 8-30 mm
- Dry cutting
- Spindle lock
- Depth adjustment
- Lock on function
- 2pcs Diamond cutting disc
- 1pc Chisel
- 1pc Wrench
- 1pc Side handle
- Packed by color box



M14



1500W 125mm

- 125mm
- 5-29 mm
- 8500 /min
- DEPTH ADJUSTMENT
- LOCK-OFF SWITCH



STOCK NO.	SIZE	QTY./CARTON
79537	1500W/125mm	4

RECIPROCATING SAW

- CE approval
- Input power: 710w
- Rated Voltage: 220-240V
- Frequency: 50/60HZ
- No Load Speed: 0-2800/min
- Stroke length: 20mm
- Max in steel: 6mm
- Max in wood: 115mm
- Plug & cable : VDE approved 2m
- Saw blade quick changing system
- Packing: colox box

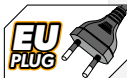

710W

- 0-2800 /min
- 20mm STROKE LENGTH
- QUICK SAW BLADE CHANGING SYSTEM
- VARIABLE SPEED
- LOCK-OFF SWITCH



1PC WOOD CUTTING BLADE
1PC METAL CUTTING BLADE



STOCK NO.	SIZE	QTY./CARTON
79540	710W	6

JIG SAW

- CE approved
- Rated voltage: 230-240V
- Frequency: 50Hz
- Input power: 800W
- Cutting speed: 800-3200/min
- Stroke Length: 20mm
- Max. in steel: 8mm
- Max. in wood: 80mm
- Footplate tilt: 0-45°, left or right
- Plug & cable: VDE approved
- Blade type: T-shank
- Accessories:
 - 1pc dust adapter
 - 1pc hex key
 - 1pc blade for wood
 - 1pc parallel guide
- Packing: color box



800W

- 800-3200 /min
- 4 POSITION ORBITAL
- VARIABLE SPEED
- LOCK-OFF SWITCH



built-in laser LASERASSIST™



STOCK NO.	SIZE	QTY./CARTON
79551	800W	6
79551-BS	800W	6

OSCILLATING MULTI-TOOL

- CE approval
- Voltage: 230-240V
- Frequency: 50Hz
- Input power: 300W
- No load speed: 15000-22000 /min
- Accessories:
 - 1pc flat scraper
 - 1pc straight blade
 - 1pc triangular sanding pad
 - 1pc semi-circular saw blade
 - 2pcs tri-sanding sheets (80,120grits)
- Packing: color box



300W

- 15000-22000 /min
- 3° OSCILLATIONS ANGLE
- VARIABLE SPEED



STOCK NO.	SIZE	QTY./CARTON
79558	300W	6

108PCS ROTARY TOOL SET

- CE approval
- Input power: 135W
- Rated Voltage: 230V
- Frequency: 50/60Hz
- No load speed: 8000-38000/min
- Accessories:
 - 10pcs grinding stones
 - 2pcs Diamond bits
 - 1pc mandrel for sanding bands
 - 1pc mandrel for cut-off wheels
 - 1pc mandrel for felt wheels
 - 36pcs cut-off wheels
 - 4pcs felt wheels
 - 4pcs sanding bands
 - 2pcs drill bits
 - 2pcs collets
 - 1pc Whet stone
 - 40pcs sanding discs
 - 1pc flexible shaft
- Packing: blow mould case



135W



M
330x250x70mm



STOCK NO.	SIZE	QTY./CARTON
79555	135W	6
79555-BS	135W	6

CUT-OFF SAW

- Rated voltage: 220-240V
- Frequency: 50/60Hz
- Input power: 2500W
- No load speed: 3700/min
- Cutting capacity: Ø110mm@90°, Ø90mm@45°
- Blade size: 355mm
- Bore size: 25.4mm
- Accessories:
 - 1pc wrench
 - 1pc cutting-off wheel
 - 1 pair carbon brush
- Packing: color box

INDUSTRIAL

2500W

355mm

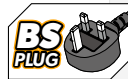

**HEAVY DUTY
STEEL BASE**
FOR CUTTING STABILITY

STOCK NO.	SIZE	QTY./CARTON
79538	2500W/355mm	1
79538-BS	2500W/355mm	1



BENCH GRINDER

- Voltage: 220-240V
- Frequency: 50Hz
- No load speed: 2950/min
- Adjustable work rest
- Accessories:
 - 1 set eye shield
 - 1 set tool rest component
- Packing: color box

150W 350W 6" 8"



STOCK NO.	SIZE	WHEEL SIZE	QTY./CARTON
79646	150W	6"/150x16x12.7mm	1
79646-BS	150W	6"/150x16x12.7mm	1
79648	350W	8"/200x20x12.7mm	1
79648-BS	350W	8"/200x20x12.7mm	1



MITRE SAW

- CE approval
- Input power: 1500W
- Rated Voltage: 220-240V
- Frequency: 50Hz
- No load speed: 5000/min
- Blade size: 210mm(8-1/4")x30mm, 24T
- Aluminium base
- Mitre cuts 0-45° left and right
- Bevel cuts 90°-45° to the left
- Max. cutting capacity:
 - 90° x 0° - 120 x 55mm
 - 45° x 0° - 83 x 55mm
 - 90° x 45° - 120 x 30mm
 - 45° x 45° - 83 x 30mm
- Dust bag keep work area clean
- Packing: carton box



1500W 210mm

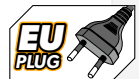

ALUMINIUM BASE

STOCK NO.	SIZE	QTY./CARTON
79529	1500W/210mm	1



MITRE SAW

- CE approval
- Input power: 1800W
- Rated Voltage: 220-240V
- Frequency: 50Hz
- No load speed: 5000/min
- Blade size: 255mm(10")x30mm, 32T
- Aluminium base
- Mitre cuts 0-45° left and right
- Bevel cuts 90° to 45° to the left
- Max. cutting capacity:
 - 90° x 0° - 140 x 70mm
 - 45° x 0° - 95 x 70mm
 - 90° x 45° - 140 x 40mm
 - 45° x 45° - 95 x 40mm
- Dust bag keep work area clean
- Packing: carton box

**built-in laser
LASERASSIST™**

**1800W
255mm**



INDUSTRIAL

ALUMINIUM BASE

STOCK NO.	SIZE	QTY./CARTON
79530	1800W/255mm	1



TABLE SAW

- CE approval
- Input power: 1500W
- Rated Voltage: 230V
- Frequency: 50Hz
- No load speed: 4500/min
- Blade size: Ø254(10")xØ30x2.8mm
- Max cutting capacity: 85mm @ 90°, 60mm @ 45°
- Blade tilting range: 0°- 45°
- Sheet metal table top
- Main Table Size: 546x630mm
- Extension Table Size(left/ right): 630X190mm
- Extension Table Size(rear): 250x540mm
- Accessories
 - 1pc Miter gauge
 - 1pc safety cover
 - 1pc Rip fence
 - 1pc Push stick
 - 1pc saw blade (254xØ30X2.8mm)
 - 1pc hex key
 - 1pc spindle nut wrench
 - 1pc open ended spanner for bracket screw
- Packing: carton box with color label

1500W 250mm NEW

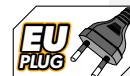

INDUSTRIAL

SHEET METAL TABLE TOP

STOCK NO.	SIZE	QTY./CARTON
79660	1500W S1	1

SCROLL SAW

- CE approval
- Input power: 90W
- Rated Voltage: 220-240V
- Frequency: 50Hz
- No load speed: 550-1600/min
- Aluminium table: 414x254mm
- Table tilting range: 45°- 90°
- Max cutting depth: 50mm
- Max cutting width: 405mm
- Blade size: 133mm x 18TPI
- Accessories
 - 1pair blade rest
 - 1pc blade 133mm x 18TPI
 - 1pc blade 133mm x 15TPI
 - 2pcs hex keys 2.5mm+3.0mm
 - 1set shield
- Packing: carton box with color label

90W S2

NEW

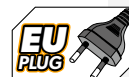

INDUSTRIAL

ALUMINIUM WORK TABLE

STOCK NO.	SIZE	QTY./CARTON
79662	90W S2	1

BAND SAW

- CE approval
- Input power: 350W
- Rated Voltage: 220V
- Frequency: 50Hz
- Aluminium table: 300x300mm
- Table tilting range: 45°- 90°
- Throat depth: 195mm
- Max. cutting height: 90mm
- Rated speed: 900/min
- Blade: 1430mmx10mmx6T
- Total height: 700mm
- Net weight: 18kg
- Accessories
 - 1pc miter gauge
 - 1pc rip fence
 - 1pc push stick
 - 1pc open ended spanner
 - 3pcs hex keys (S2, S3, S4)
- Packing: carton box

350W S2

NEW

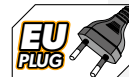

INDUSTRIAL

ALUMINIUM WORK TABLE

STOCK NO.	SIZE	QTY./CARTON
79664	350W S2	1

DRILL PRESS

- Voltage: 230V
- Frequency: 50Hz
- No load speed: 620-2620/min
- 5 spindle speeds
- Spindle travel: 50mm
- Spindle taper: B16
- Chuck capacity: 13mm
- Table size: 160x160mm
- Base size: 290x190mm
- Max. distance from spindle end to surface of table: 220mm
- Gross weight: 16kgs
- Machine height: 580mm
- Packing: color box

350W



WITH CHUCK GUARD



STOCK NO.	SIZE	QTY./CARTON
79650	350W	1



DRILL PRESS

- CE approved
- Voltage: 230V
- Frequency: 50Hz
- No load speed: 620-2620/min
- 5 spindle speeds
- Spindle travel: 50mm
- Spindle taper: B16
- With chuck guard
- With micro-switch
- Chuck capacity: 13mm
- Electromagnetic switch
- Table size: 160x160mm
- Base size: 290x190mm
- Max. distance from spindle end to surface of table: 220mm
- Gross weight: 16kgs
- Machine height: 580mm
- Packing: color box

350W



STOCK NO.	SIZE	QTY./CARTON
79651	350W	1



DRILL PRESS

- Voltage: 230V
- Frequency: 50Hz
- No load speed: 180~2770/min
- 16 spindle speeds
- Spindle travel: 80mm
- Spindle Taper: MT2
- Chuck capacity: 16mm
- Table diameter: Ø290mm
- Table tilt: 45° left and right
- Base size: 420x250mm
- Max. distance from spindle end to surface of table: 450mm
- Net weight: 38Kgs
- Machine height: 980mm
- Packing: carton box

550W



STOCK NO.	SIZE	QTY./CARTON
79652	550W	1

DRILL PRESS

- Voltage: 230V
- Frequency: 50Hz
- No load speed: 180~2770/min
- 16 spindle speeds
- Spindle travel: 80mm
- Spindle Taper: MT2
- Chuck capacity: 16mm
- Table diameter: Ø290mm
- Table tilt: 45° left and right
- Base size: 460x270mm
- Max. distance from spindle end to surface of table: 725mm
- Net weight: 55Kgs
- Machine height: 1580mm
- Packing: carton box

750W



STOCK NO.	SIZE	QTY./CARTON
79654	750W	1

DRILL PRESS

- Voltage: 230V
- Frequency: 50Hz
- No load speed: 150-2450/min
- 12 spindle speeds
- Spindle travel: 120mm
- Spindle Taper: MT4
- Chuck capacity: 32mm
(Accessories: 1pc chuck 20mm)
- Table size: 420x480mm
- Table tilt: 45° left and right
- Base size: 575x425mm
- Max. distance from spindle end to surface of table: 700mm
- Net weight: 125Kgs
- Machine height: 1710mm
- Packing: carton box

1500W



STOCK NO.	SIZE	QTY./CARTON
79656	1500W	1

INDUSTRIAL

HIGH PRESSURE WASHER

- CE approval
- Input power: 1400W
- Rated Voltage: 230V
- Frequency: 50HZ
- Max pump pressure: 105Bar(1500psi)
- Flow rate: 5L/min
- Auto suction function
- Temperature protection
- Pressure protection
- Plug & cable : VDE approved 5m
- Accessories contain
 - 1set washing gun with adjustable nozzle
 - 1pc high pressure hose 5 meters
 - 1pc soap bottle
 - 1pc tap adaptor
 - 1pc hose connector
 - 1pc cleaning pin
- Packing: color box

1400W

105Bar
Max. pressure



STOCK NO.	SIZE	QTY./CARTON
79588	1400W/105Bar	1

HIGH PRESSURE WASHER

- CE approval
- Input power: 1700W
- Rated Voltage: 230V
- Frequency: 50HZ
- Max pump pressure: 135Bar(2000psi)
- Flow rate: 5L/min
- Auto suction function
- Temperature protection
- Pressure protection
- Plug & cable : VDE approved 7m
- Accessories contain
 - 1set washing gun with adjustable nozzle
 - 1pc high pressure hose 7 meters
 - 1pc soap bottle
 - 1pc tap adaptor
 - 1pc hose connector
 - 1pc cleaning pin
- Packing: color box

1700W

135Bar
Max. pressure



STOCK NO.	SIZE	QTY./CARTON
79589	1700W/135Bar	1

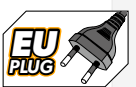
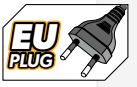

PETROL PRESSURE WASHER

- Pump Type: 3-Piston Axial cam Pump-Aluminium
- Max Output: 7.0Hp / 5250W
- Max. Pressure: 220Bar (3190PSI)
- Rated Pressure: 180Bar (2610PSI)
- Flow Rate: 8.3L/min
- Engine Type :OHV 4-stroke
- Displacement : 208CC
- Starting System : Recoil
- Engine Speed : 3600RPM
- Fuel volume : 3.6L
- Oil Volume : 0.6L
- Fuel Type: Unleaded Gasoline
- Net weight: 29kg
- 1 Pcs metal lance
- 1 Pcs metal gun
- 8m pressure hose
- Five nozzles
- Packing: color box

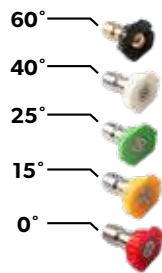

7HP
220Bar
Max. pressure

- 4-STROKE AIR-COOLED GASOLINE ENGINE
- 180 Bar (2160psi) RATED PRESSURE
- 220 Bar (3190psi) MAX. PRESSURE
- 8.3L/mh RATED FLOW
- 3.6L FUEL TANK CAPACITY



STOCK NO.	SIZE	QTY./CARTON
79576	5250W (7Hp)/220Bar	1

VACUUM CLEANER **1200W** **30L**

- Wet and dry cleaning
- Input power: 1200W
- Voltage: 220-240V
- Frequency: 50/60Hz
- Copper wire motor
- Stainless steel tank
- Dust capacity: 30L
- Air flow: 1.9m³/min
- Vacuum pressure: 17KPa
- 1.5m flexible hose
- 2pcs plastic tubes
- 1pc sponge filtration
- 1set 2 in 1 brush
- 1pc flat mouth
- 1pc columnar cartridge
- Total 2.3m cord length
- HEPA filter
- Packing: color box

- WET CLEANING
- DRY CLEANING

- 30L
- 17KPa VACUUM PRESSURE
- 1.9m³/min



STAINLESS STEEL TANK

STOCK NO.	DUST CAPACITY	QTY./CARTON
79608	30L	1



VACUUM CLEANER

2x1000W
70L

- Wet and dry cleaning
- Input power: 2x1000W
- Voltage: 220-240V
- Frequency: 50/60Hz
- Copper wire motor
- Stainless steel tank
- Dust capacity: 70L
- Air flow: 3m³/min
- Vacuum pressure: 18KPa
- 2.5m flexible hose
- 2pcs metal tubes
- 2pcs 40cm square brushes
- 1pc sponge filtration
- 1set round head brush
- 1pc big flat mouth
- Total 2.3m cord length
- HEPA filter
- Packing: carton

- WET CLEANING
- DRY CLEANING

- 70L
- 18KPa VACUUM PRESSURE
- 3m³/min



STAINLESS STEEL TANK

STOCK NO.	DUST CAPACITY	QTY./CARTON
79609	70L	1

5PCS VACUUM COLLECTOR BAG SET

- Brown paper material
- Ideal for dust, dirt and fine debris collection
- 5pcs per pack
- Packing: color box



STOCK NO.	SIZE	QTY./CARTON
79787	15L	100
79788	20L	100
79789	30L	100



INDUSTRIAL

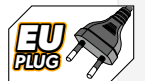

INDUSTRIAL

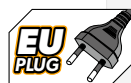

PERIPHERAL PUMP

0.5HP

- Input power: 370W (0.5Hp)
- Rated Voltage: 220-240V
- Frequency: 50Hz
- Max. head: 35m
- Max. flow: 35L/min
- Max. suction: 8m
- Pipe diameter: 1" x 1"
- Copper wire motor
- Copper impeller
- 0.3m length cable
- Packing: color box

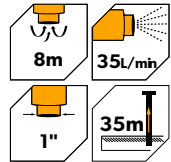

COPPER
IMPELLER

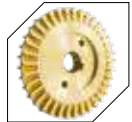

PERFORMANCE CURVE

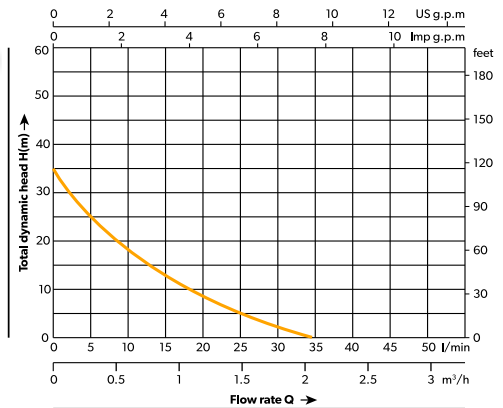

STOCK NO.	SIZE	QTY./CARTON
79970	370W (0.5HP)	4

JET PUMP

1HP

- Input power: 750W (1Hp)
- Rated Voltage: 220-240V
- Frequency: 50Hz
- Max. head: 45m
- Max. flow: 60L/min
- Max. suction: 8m
- Pipe diameter: 1" x 1"
- Copper wire motor
- Copper impeller
- 0.3m length cable
- Packing: color box

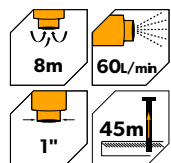

COPPER
IMPELLER



PERFORMANCE CURVE

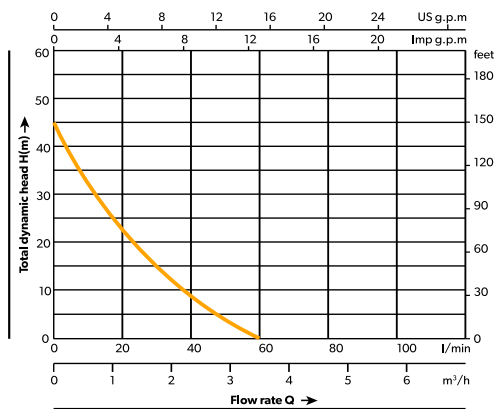

STOCK NO.	SIZE	QTY./CARTON
79973	750W (1Hp)	1

CENTRIFUGAL PUMP

1HP

- Input power: 750W (1Hp)
- Rated Voltage: 220-240V
- Frequency: 50Hz
- Max. head: 32m
- Max. flow: 110L/min
- Max. suction: 8m
- Pipe diameter: 1" x 1"
- Copper wire motor
- Copper impeller
- 0.3m length cable
- Packing: color box

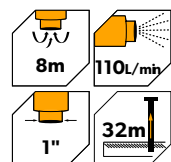

COPPER
IMPELLER



PERFORMANCE CURVE

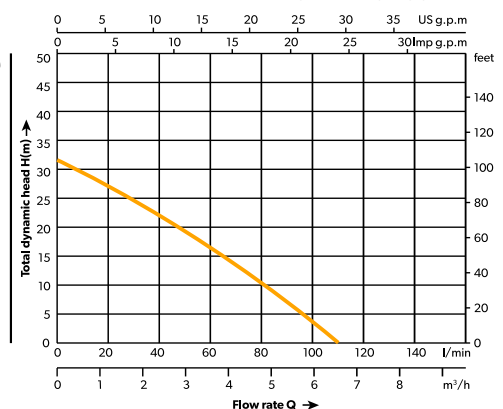

STOCK NO.	SIZE	QTY./CARTON
79975	750W (1Hp)	1

SUBMERSIBLE CLEAN WATER PUMP

- Rated Voltage: 220-240V
- Frequency: 50Hz
- Pipe diameter: 1"
- Copper wire motor
- With float switch
- Thermal protection
- 8m length cable
- Packing: color box



0.5HP

1HP



PERFORMANCE CURVE

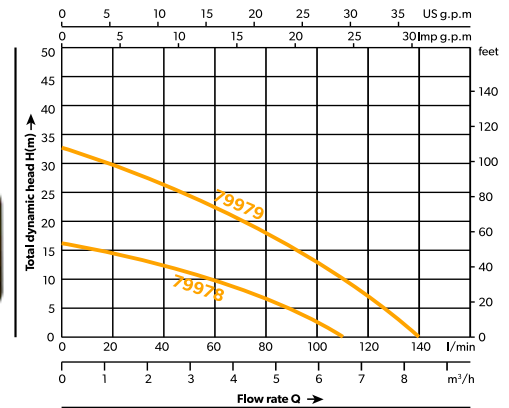

79978

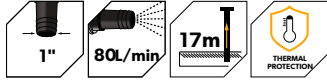

79979

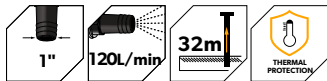

STOCK NO.	SIZE	QTY./CARTON
79978	370W (0.5Hp)	1
79979	750W (1Hp)	1

AUTOMATIC SELF-PRIMING PERIPHERAL PUMPS

- Input power: 370W (0.5Hp)
- Voltage: 220-230V
- Frequency: 50Hz
- Tank capacity: 2L
- Max. head: 30m
- Max. flow: 3.5L/min
- Max. suction: 8m
- Working pressure range: 1.5kg-2.5kg
- Pipe diameter: 1"x1"
- Copper wire motor
- Copper impeller
- 0.8m length cable
- Packing: color box



0.5HP

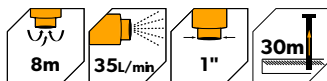
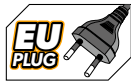

STOCK NO.	SIZE	MAX. HEAD	QTY./CARTON
79966	370W (0.5Hp)	30m	1



DEEP WELL PUMP

- CE approval
- Voltage: 220-240V
- Frequency: 50Hz
- Rate flow: 2.0m³/H
- Max. flow: 4.0m³/H
- Well pump body: 4"
- Impeller: 6 stage
- Copper wire motor
- Pump body: Stainless steel
- Control box is included
- Packing: color label



INDUSTRIAL

STOCK NO.	SIZE	MAX. FLOW	QTY./CARTON
79961	370W/0.5Hp	4.0m ³ /H	1
79962	550W/0.75Hp	4.0m ³ /H	1
79963	750W/1Hp	4.0m ³ /H	1
79964	1100W/1.5Hp	4.0m ³ /H	1

AUTOMATIC PUMP CONTROL **1100W**



- CE approval
- Input power: 1100w
- Rated Voltage: 220-240V
- Frequency: 50/60Hz
- Max. current: 10A
- Starting pressure: 1.5bar
- Max. working pressure: 10bar
- Pipe diameter: 1"x1"
- Waterproof Rate: IP65
- Packing: color box



STOCK NO.	SIZE	QTY./CARTON
79968	1100W	12

AUTOMATIC PUMP CONTROL **1100W**



- CE approval
- Input power: 1100w
- Rated Voltage: 220-240V
- Frequency: 50/60Hz
- Max. current: 10A
- Starting pressure: 1.5bar
- Max. working pressure: 10bar
- Pipe diameter: 1"x1"
- Waterproof Rate: IP65
- Packing: color box



STOCK NO.	SIZE	QTY./CARTON
79969	1100W	12

GASOLINE PUMP

- Displacement: 212cc
- Rated power: 4000W
- 4-stroke, air-cooled gasoline engine
- Maximum head height: 30m
- Maximum suction: 8m
- Start: recoil
- Packing: color lable

7HP



4-STROKE
AIR-COOLED
GASOLINE
ENGINE

3.6L

8m

30m

INDUSTRIAL



STOCK NO.	DIA OF SUCTION&OUTPUT	MAXIMUM OUTPUT	QTY./CARTON
79981	50mm, 2"	500L/min	1
79982	75mm, 3"	1000L/min	1

SOLENOID SPRAY GUN

- CE approval
- 220-240V~, 50Hz, 110W
- Paint Reservoir: 800ml
- Max. Viscosity: 60din/sec
- Max. Flow: 300ml/min
- Nozzle: 0.8mm
- Cable length: 2.0m
- Accessories:
 - 1pc viscosity measuring cup
 - 1pc cleaning pin
 - 2pcs valves
 - 1pc 0.8mm spare nozzle
 - 1pc wrench
- Packing: color box

1100W



300ml/min
MAX. FLOW

0.8mm

800ml

ADJUSTABLE
OUTPUT
VALVE



STOCK NO.	SIZE	QTY./CARTON
79577	110W	6

HVLP HAND HELD SPRAY GUN

- CE approval
- 220-240V~, 50Hz, 400W
- Paint Reservoir: 800ml
- Max. Flow: 800ml/min
- Max. Viscosity: 60din/sec
- Nozzle: 1.8/2.6mm
- Cable length: 2.0m
- Accessories:
 - 1pc viscosity measuring cup
 - 1pc 2.6mm nozzle
 - 1pc cleaning pin
- Packing: color box

400W

800ml/min
MAX. FLOW

1.8/2.6
mm

800ml

ADJUSTABLE
OUTPUT
VALVE

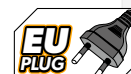

STOCK NO.	SIZE	QTY./CARTON
79578	400W	6

HVLP FLOOR BASED SPRAY GUN

- CE approval
- 220-240V~, 50Hz, 650W
- Paint Reservoir: 800ml
- Max. Flow: 800ml/min
- Max. Viscosity: 60din/sec
- Nozzle: 1.8/2.6mm
- Cable length: 2.0m
- Accessories:
 - 1pc viscosity measuring cup
 - 1pc 2.6mm nozzle
 - 1pc shoulder belt
 - 1pc cleaning pin
- Packing: color box

650W

800ml/min
MAX. FLOW

1.8/2.6
mm

800ml

ADJUSTABLE
OUTPUT
VALVE

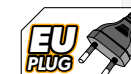

STOCK NO.	SIZE	QTY./CARTON
79579	650W	4

HOT AIR GUN

- CE approved
- Voltage&Frequency: 230V~50Hz
- Rate Power: Max.2000W
- Temperature I/II/III: 50/70-600/70-600°C
- Air Flow I/II/III: 300/300/500L/min
- This heat gun is with LCD digital display, which shows actually temperature so that temperature can be controlled by operator easily
- Accessories
 - 1 pc pointed nozzle
 - 1 pc reversing nozzle
 - 1 pc wide angle nozzle
 - 1 pc edge protection nozzle
 - 1 pc Triangular blade scraper
- Packing: color box

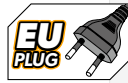

2000W

50°C
300L/min

70-600°C
300L/min

70-600°C
500L/min



HANDS FREE
SUPPORT
STAND



STOCK NO.	SIZE	QTY./CARTON
79792	2000W	10

HOT AIR GUN

- Approved by TUV/GS, CE+EMC
- Rated voltage: 230V~50Hz
- 2 adjustable temperature ranges
 - range 1 = 1000W, 300L/min at 350°C
 - range 2 = 2000W, 500L/min at 550°C
- Accessories
 - 1 pc pointed nozzle
 - 1 pc reversing nozzle
 - 1 pc wide angle nozzle
 - 1 pc edge protection nozzle
- Packing: color box



2000W

350°C
300L/min

550°C
500L/min



HANDS FREE
SUPPORT
STAND



STOCK NO.	SIZE	QTY./CARTON
79100	2000W	10
79100-BS	2000W	10

BLOWER

- CE approved
- Rated voltage: 220-240V~50Hz
- Input power: 400W
- No-load speed: 13000/min
- Max blowing rate: 3.0m³/min
- With 1pc dust bag
- 2 tools in 1: blower and vacuum cleaner
- Packing: color box

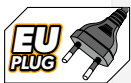

400W

13000
/min

3.0m³/min

LOCK-OFF
SWITCH



STOCK NO.	SIZE	QTY./CARTON
79604	400W	4

BLOWER

- CE approved
- Rated voltage: 220-240V~50Hz
- Input power: 600W
- No-load speed: 0-16000/min
- Max blowing rate: 3.5m³/min
- Variable speed
- With 1pc dust bag
- 2 tools in 1: blower and vacuum cleaner
- Packing: color box

INDUSTRIAL



600W

0-16000
/min

0-3.5m³/min

VARIABLE
SPEED

LOCK-OFF
SWITCH



STOCK NO.	SIZE	QTY./CARTON
79606	600W	4

MIXER

- CE approved
- Mixer for cement or paint
- Voltage: 220-240V
- Frequency: 50Hz
- Input power: 1800W
- No load speed: 180-400/300-700 /min
- Clamp thread: M14
- Mixing paddle diameter: 140mm
- Suitable materials: plaster, cement, mortar tile Adhesive, Render
- Packing: color box

INDUSTRIAL



1800W



STOCK NO.	SIZE	QTY./CARTON
79509	1800W	2

CONCRETE MIXER

- CE approved
- Rated Voltage: 230V
- Frequency: 50Hz
- Thickness: up drum 1.2mm, lower drum 1.8mm
- Cast iron gear ring
- Handle: round handle
- Packing: carton box

NEW

850W
200L



STOCK NO.	SIZE	POWER	DRUM SPEED	DRUM OPENING	QTY./CARTON
79953	200L	850W	27rpm	400mm	1

EXHAUST FAN

- CE approved
- Voltage: 220-240V
- Frequency: 50/60Hz
- Noise: 40dB
- Material: PP+AS, 100% new material
- Installation: wall mounted
- Suitable for kitchen, toilet and bathroom
- High efficiency copper wire motor, powerful air exhaust
- Easy installation and clean
- Switch: Pull cord
- Without plug
- Packing: color box



15W

150mm 6"

20W

200mm 8"



STOCK NO.	SIZE	INPUT POWER	AIR FLOW	QTY./CARTON
79598	150mm, 6"	15W	210m³/h	20
79599	200mm, 8"	20W	300m³/h	14

EXHAUST FAN

- CE approved
- Voltage: 220-240V
- Frequency: 50/60Hz
- Noise: 42dB
- Material: PP, 100% new material
- Installation: wall mounted
- Suitable for kitchen, toilet and bathroom
- High efficiency copper wire motor, powerful air exhaust
- Easy installation and clean
- Without plug
- Packing: color box



28W

200mm 8"

38W

250mm 10"

48W

300mm 12"



STOCK NO.	SIZE	INPUT POWER	AIR FLOW	QTY./CARTON
79600	200mm, 8"	28W	520m³/h	6
79601	250mm, 10"	38W	860m³/h	6
79602	300mm, 12"	48W	1200m³/h	5

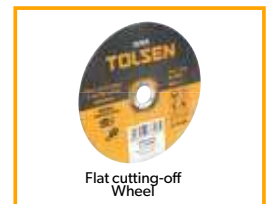
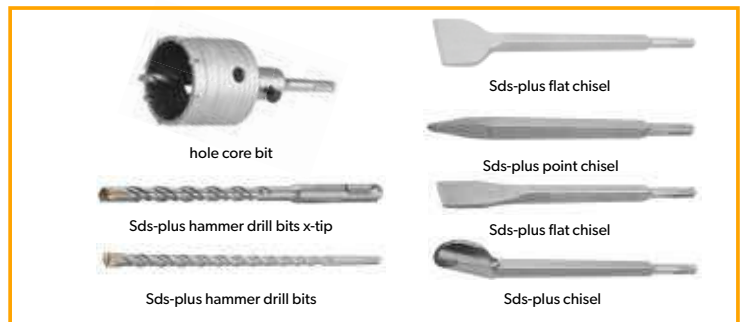
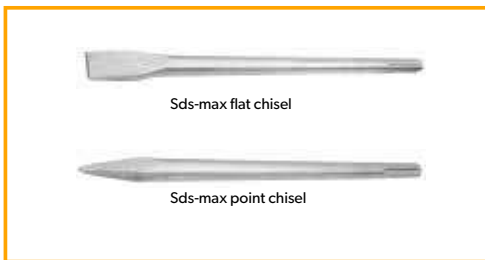
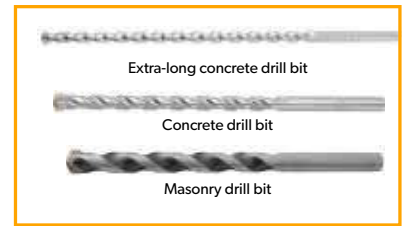

TOLSEN

POWER TOOL ACCESSORIES

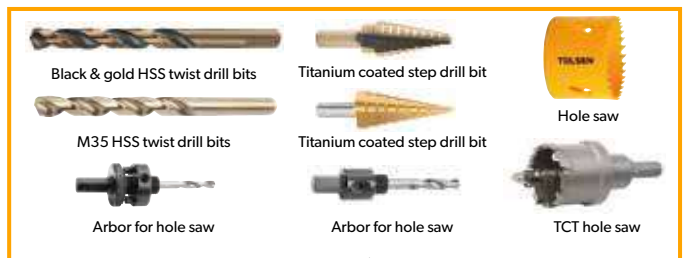
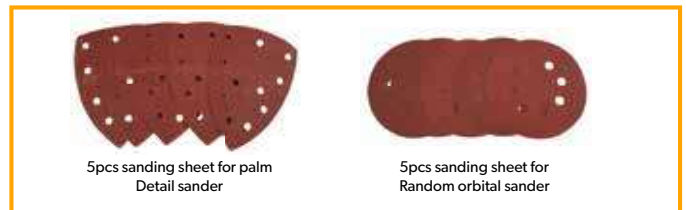
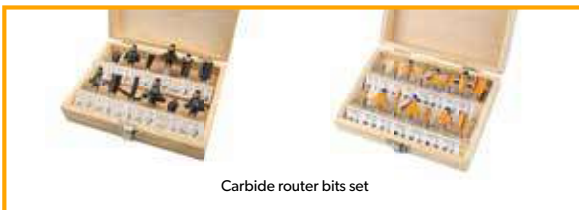



POWER TOOL ACCESSORIES



SDS-PLUS HAMMER DRILL BITS X-TIP

- High quality TCT tip
- Chrome alloy steel body
- SDS plus shank, Double flute
- Sand blasting finishing
- Packing: plastic hanger with color label & shrink



STOCK NO.	AxL	QTY./CARTON
74802	6x110mm	200
74822	6x160mm	200
74804	8x110mm	200
74824	8x160mm	200
74826	10x160mm	200
74828	12x160mm	200
74830	14x160mm	100
74832	16x160mm	100
74842	6x210mm	200
74844	8x210mm	200
74846	10x210mm	200
74848	12x210mm	200
74850	14x210mm	100
74852	16x210mm	100
74864	8x260mm	200
74866	10x260mm	200
74868	12x260mm	100
74870	14x260mm	100
74872	16*260mm	50
74874	18x260mm	50
74886	10x310mm	100
74888	12x310mm	100
74890	14x310mm	100
74892	16x310mm	50
74894	18x310mm	50
74906	10x460mm	100
74908	12x460mm	100
74910	14x460mm	50
74912	16x460mm	50
74914	18x460mm	25
74916	20x460mm	25
74918	22x460mm	25
74921	25x460mm	25

INDUSTRIAL

SDS-PLUS HAMMER DRILL BITS

- High quality TCT tip
- Chrome alloy steel body
- SDS plus shank, Double flute
- Sand blasting finishing
- Packing: plastic hanger with color label



STOCK NO.	AxL	QTY./CARTON
75301	5x110mm	400
75317	5.5x110mm	400
75302	6x110mm	400
75318	6.5x110mm	400
75303	7x110mm	320
75304	8x110mm	320
75306	10x110mm	320
75308	12x110mm	240
75321	5x160mm	320
75337	5.5x160mm	320
75322	6x160mm	320
75338	6.5x160mm	320
75323	7x160mm	320
75324	8x160mm	240
75325	9x160mm	240
75326	10x160mm	240
75327	11x160mm	240
75328	12x160mm	160
75329	13x160mm	160
75330	14x160mm	160
75342	6x210mm	240
75343	6.5x210mm	240
75344	8x210mm	240
75346	10x210mm	160
75347	11x210mm	160
75348	12x210mm	160
75349	13x210mm	120
75350	14x210mm	120
75352	16x210mm	80
75377	5.5x260mm	200
75362	6x260mm	200
75378	6.5x260mm	200
75363	7x260mm	200
75364	8x260mm	160
75365	9x260mm	160
75366	10x260mm	160
75367	11x260mm	160
75368	12x260mm	120
75369	13x260mm	120
75370	14x260mm	80
75372	16x260mm	80
75384	8x310mm	160
75386	10x310mm	120
75387	11x310mm	120
75388	12x310mm	120
75390	14x310mm	80
75392	16x310mm	60
75394	18x310mm	40
75396	20x310mm	40
75406	10x450mm	80
75408	12x450mm	80
75409	13x450mm	60
75410	14x450mm	60
75412	16x450mm	40
75414	18x450mm	40
75415	20x450mm	30
75416	22x450mm	30
75417	24x450mm	25
75421	32x450mm	10

SDS-PLUS HAMMER DRILL BITS

- High quality TCT tip
- Chrome alloy steel body
- SDS plus shank, Double flute
- Sand blasting finishing
- Packing: plastic hanger

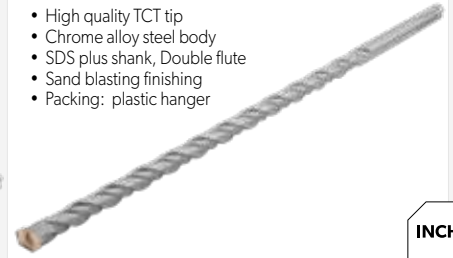

INCH



STOCK NO.	AxL	QTY./CARTON
74606	3/16x6"	200
74607	1/4x6"	200
74608	5/16x6"	200
74609	3/8x6"	200
74611	1/2x6"	160
74613	5/8x6"	100
74614	3/4x6"	100
74635	5/16x12"	100
74636	3/8x12"	100
74638	1/2x12"	80
74640	5/8x12"	40
74641	3/4x12"	40

SDS-PLUS POINT CHISEL

- Chrome alloy steel body
- Sand blasting finishing
- Packing: plastic hanger with color label

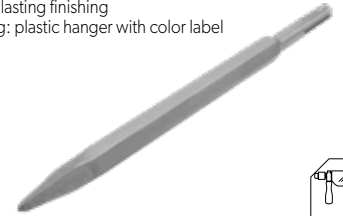

STOCK NO.	SIZE	QTY./CARTON
75440	14x250mm	60

SDS-PLUS FLAT CHISEL

- Chrome alloy steel body
- Sand blasting finishing
- Packing: plastic hanger with color label



STOCK NO.	SIZE	QTY./CARTON
75441	14x250 x 20mm	60

SDS-PLUS FLAT CHISEL

- Chrome alloy steel body
- Sand blasting finishing
- Packing: plastic hanger with color label



STOCK NO.	SIZE	QTY./CARTON
75442	14x250x40mm	60

SDS-PLUS CHISEL

- Chrome alloy steel body
- Sand blasting finishing
- Packing: plastic hanger with color label



STOCK NO.	SIZE	QTY./CARTON
75448	14x250x22mm	60

SDS-MAX POINT CHISEL

- Chrome alloy steel body
- Sand blasting finishing
- Packing: plastic hanger with color label



STOCK NO.	SIZE	QTY./CARTON
75456	18x400mm	30

SDS-MAX FLAT CHISEL

- Chrome alloy steel body
- Sand blasting finishing
- Packing: plastic hanger with color label



STOCK NO.	SIZE	QTY./CARTON
75457	18x400x25mm	30

HEX POINT CHISEL

- Chrome alloy steel body
- Sand blasting finishing
- Packing: plastic tube with color label



STOCK NO.	SIZE	QTY./CARTON
75450	17x280mm	40

HEX FLAT CHISEL

- Chrome alloy steel body
- Sand blasting finishing
- Packing: plastic tube with color label



STOCK NO.	SIZE	QTY./CARTON
75451	17x280x25mm	40

HEX POINT CHISEL

- Chrome alloy steel body
- Sand blasting finishing
- Suitable for TOLSEN stock No.88552 88553
- Packing: plastic hanger with color label



STOCK NO.	SIZE	QTY./CARTON
75454	30x410mm	12

HEX FLAT CHISEL

- Chrome alloy steel body
- Sand blasting finishing
- Suitable for TOLSEN stock No.88552 88553
- Packing: plastic hanger with color label



STOCK NO.	SIZE	QTY./CARTON
75455	30x410x35mm	12

MASONRY DRILL BITS

- ISO5468, DIN8039
- High quality TCT tip
- 130° general angle
- Cylindrical shank
- Black finished with polished surface
- Application in all rotary and percussion drilling machines
- For use in brick masonry block Light concrete
- Packing: blister card

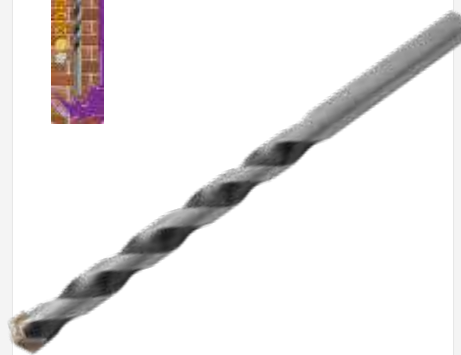

STOCK NO.	SIZE	QTY./CARTON
75460	3x60mm	300
75461	4x75mm	300
75462	5x85mm	300
75475	5.5x100mm	300
75463	6x100mm	200
75476	6.5x100mm	200
75477	7.0x100mm	200
75464	8x120mm	200
75478	9x120mm	160
75465	10x120mm	160
75466	12x150mm	120
75479	13x150mm	100
75467	14x150mm	100
75468	16x150mm	80

5PCS MASONRY DRILL BITS SET

- ISO5468, DIN8039
- High quality TCT tip
- 130° general angle
- Cylindrical shank
- Chrome plated surface
- Application in all rotary and percussion drilling machines
- For use in brick masonry block light concrete
- Packing: plastic box



STOCK NO.	SIZE	QTY./CARTON
75459	4x75, 5x85, 6x100, 8x120, 10x120 mm	80

CONCRETE DRILL BIT

- High quality TCT tip
- Chrome alloy steel body
- Round shank, double flute
- Sand blasting finishing
- Packing: blister card



STOCK NO.	SIZE	QTY./CARTON
75500	3.0x60mm	400
75501	4.0x75mm	400
75502	4.5x75mm	400
75503	5.0x85mm	400
75504	5.5x100mm	400
75505	6.0x100mm	400
75506	6.5x100mm	400
75507	7.0x100mm	320
75508	8.0x120mm	320
75509	8.5x120mm	320
75510	9.0x120mm	320
75511	10.0x120mm	240
75512	11.0x150mm	240
75513	12.0x150mm	240
75514	13.0x150mm	160
75515	14.0x150mm	160
75516	15.0x150mm	160
75517	16.0x150mm	80
75518	18.0x160mm	80
75519	19.0x160mm	80
75520	20.0x160mm	80
75521	22.0x160mm	60
75522	24.0x160mm	60
75523	25.0x160mm	60

EXTRA-LONG CONCRETE DRILL BIT

- High quality TCT tip
- Chrome alloy steel body
- Round shank, double flute
- Sand blasting finishing
- Packing: PVC bag



STOCK NO.	SIZE	QTY./CARTON
75530	8.0x200mm	240
75540	6.0x300mm	120
75544	13.0x300mm	80
75545	14.0x300mm	80
75547	18.0x300mm	40
75548	20.0x300mm	30
75549	25.0x300mm	30
75560	6.0x400mm	80
75564	13.0x400mm	60
75567	18.0x400mm	40
75568	20.0x400mm	30
75569	25.0x400mm	30

M2 HSS TWIST DRILL BITS

- HSS/M2, DIN338
- Fully ground
- 135° split point
- Packing: blister card



SPLIT POINT

STOCK NO.	SIZE	FLUTE LENGTH	QTY./CARTON
75040	1.0x34mm	12mm	160sets (2pcs)
75041	1.5x40mm	18mm	160sets (2pcs)
75042	2.0x49mm	24mm	160sets (2pcs)
75043	2.5x57mm	30mm	160sets (2pcs)
75073	4.2x75mm	43mm	80
75047	4.5x80mm	47mm	80
75055	8.5x117mm	75mm	60
75056	9.0x125mm	81mm	60
75061	11.5x142mm	94mm	40

BLACK & GOLD HSS TWIST DRILL BITS

- HSS/M2, DIN338
- High Speed Steel features a gold shank and black flute
- 130° Split point
- Packing: plastic box



SPLIT POINT

STOCK NO.	SIZE	FLUTE LENGTH	QTY./CARTON
75105	1.0x34mm	12mm	40
75106	1.5x40mm	18mm	40
75107	2.0x49mm	24mm	40
75108	2.5x57mm	30mm	40
75109	3.0x61mm	33mm	40
75110	3.2x65mm	32mm	40
75111	3.5x70mm	39mm	40
75112	3.8x75mm	43mm	40
75113	4.0x75mm	43mm	40
75114	4.2x75mm	43mm	24
75115	4.5x80mm	47mm	24
75116	4.8x86mm	52mm	24
75117	5.0x86mm	52mm	24
75118	5.5x93mm	57mm	24
75119	6.0x93mm	57mm	24
75120	6.5x101mm	63mm	16
75121	7.0x109mm	69mm	16
75122	7.5x109mm	69mm	16
75123	8.0x117mm	75mm	16
75124	8.5x117mm	75mm	16
75125	9.0x125mm	81mm	16
75126	9.5x125mm	81mm	16
75127	10.0x133mm	87mm	16
75128	10.5x133mm	87mm	16
75129	11.0x142mm	94mm	16
75130	11.5x142mm	94mm	16
75131	12.0x151mm	101mm	16
75132	12.5x151mm	101mm	16
75133	13.0x151mm	101mm	16

19PCS BLACK & GOLD HSS TWIST DRILL BITS SET

- HSS/M2, DIN338
- High Speed Steel features a gold shank and black flute
- 130° Split point
- 3-flatted shank on 5mm and above for better chuck grip
- Packing: plastic box with color label



STOCK NO.	SIZE	QTY./CARTON
75086	1,1.5,2,2.5,3,3.5,4,4.5,5,5.5,6,6.5,7,7.5,8,8.5,9,9.5,10mm	24

25PCS BLACK & GOLD HSS FRACTIONAL STRAIGHT SHANK JOBBER LENGTH DRILL BITS SET

- HSS/M2, DIN338
- High Speed Steel features a gold shank and black flute
- 130° Split point
- 3-flatted shank on 5mm and above for better chuck grip
- Packed by plastic box



STOCK NO.	SIZE	QTY./CARTON
75087	1, 1.5, 2, 2.5, 3, 3.5, 4, 4.5, 5, 5.5, 6, 6.5, 7, 7.5, 8, 8.5, 9, 9.5, 10, 10.5, 11, 11.5, 12, 12.5, 13mm	10

13PCS HSS TWIST DRILL BITS SET

- HSS, DIN338
- Roll forged
- 118° general angle
- Packing: iron box with color label



STOCK NO.	SIZE	QTY./CARTON
75080	1.5, 2, 2.5, 3, 3.2, 3.5, 4, 4.5, 4.8, 5, 5.5, 6, 6.5mm	48

19PCS HSS TWIST DRILL BITS SET

- HSS, DIN338
- Roll forged
- 118° general angle
- Packing: iron box with color label



STOCK NO.	SIZE	QTY./CARTON
75081	1.5, 2, 2.5, 3, 3.2, 3.5, 4, 4.5, 4.8, 5, 5.5, 6, 6.5, 7, 7.5, 8, 8.5, 9, 9.5, 10mm	48

25PCS HSS TWIST DRILL BITS SET

- HSS, DIN338
- Roll forged
- 118° general angle
- Packing: iron box with color label



STOCK NO.	SIZE	QTY./CARTON
75082	1, 1.5, 2, 2.5, 3, 3.5, 4, 4.5, 5, 5.5, 6, 6.5, 7, 7.5, 8, 8.5, 9, 9.5, 10, 10.5, 11, 11.5, 12, 12.5, 13mm	10

M35 HSS TWIST DRILL BITS

- HSS/M35 (Co5%), DIN338
- Fully ground
- 135° split point
- Packing: blister card



INDUSTRIAL J

SPLIT POINT
COBALT⁺



Co
5%

STOCK NO.	SIZE	FLUTE LENGTH	QTY./CARTON
75140	1.0x34mm	12mm	160sets (2pcs)
75141	1.5x40mm	18mm	160sets (2pcs)
75142	2.0x49mm	24mm	160sets (2pcs)
75143	2.5x57mm	30mm	160sets (2pcs)
75144	3.0x61mm	33mm	160sets (2pcs)
75172	3.2x65mm	36mm	80
75145	3.5x70mm	39mm	80
75146	4.0x75mm	43mm	80
75173	4.2x75mm	43mm	80
75147	4.5x80mm	47mm	80
75174	4.8x86mm	52mm	80
75148	5.0x86mm	52mm	80
75149	5.5x93mm	57mm	80
75150	6.0x93mm	57mm	80
75151	6.5x101mm	63mm	60
75152	7.0x109mm	69mm	60
75153	7.5x109mm	69mm	60
75154	8.0x117mm	75mm	60
75155	8.5x117mm	75mm	60
75156	9.0x125mm	81mm	60
75157	9.5x125mm	81mm	60
75158	10.0x133mm	87mm	60
75159	10.5x133mm	87mm	60
75160	11.0x142mm	94mm	40
75161	11.5x142mm	94mm	40
75162	12.0x151mm	101mm	40
75163	12.5x151mm	101mm	40
75164	13.0x151mm	101mm	40
75165	14.0x160mm	108mm	40
75166	15.0x169mm	114mm	40
75167	16.0x178mm	120mm	40

HSS FRACTIONAL JOBBER LENGTH DRILL BITS

- HSS/M35 (Co5%), ASME B.94.11M
- Fully ground
- 135° split point
- Packing: blister card



INDUSTRIAL J

SPLIT POINT
COBALT⁺



Co
5%

STOCK NO.	SIZE	FLUTE LENGTH	QTY./CARTON
75200	1/16"x1-7/8"	7/8"	160sets (2pcs)
75201	5/64"x2"	1"	160sets (2pcs)
75202	3/32"x2-1/4"	1-1/4"	160sets (2pcs)
75203	7/64"x2-5/8"	1-1/2"	160sets (2pcs)
75204	1/8"x 2-3/4"	1-5/8"	160sets (2pcs)
75205	9/64"x2-7/8"	1-3/4"	80
75206	5/32"x 3-1/8"	2"	80
75207	11/64"x 3-1/4"	2-1/8"	80
75208	3/16"x3-1/2"	2-5/16"	80
75209	13/64"x 3-5/8"	2-7/16"	80
75210	7/32"x 3-3/4"	2-1/2"	80
75211	15/64"x3-7/8"	2-5/8"	80
75212	1/4"x4"	2-3/4"	80
75213	17/64"x4-1/8"	2-7/8"	80
75214	9/32"x4-1/4"	2-15/16"	60
75215	19/64"x 4-3/8"	3-1/16"	60
75216	5/16"x4-1/2"	3-3/16"	60
75217	21/64"x4-5/8"	3-5/16"	60
75218	11/32"x4-3/4"	3-7/16"	60
75219	23/64"x4-7/8"	3-1/2"	60
75220	3/8"x5"	3-5/8"	60
75221	25/64"x5-1/8"	3-3/4"	60
75222	13/32"x5-1/4"	3-7/8"	60
75223	27/64"x5-3/8"	3-15/16"	40
75224	7/16"x5-1/2"	4-1/16"	40
75225	29/64"x5-5/8"	4-3/16"	40
75226	15/32x5-3/4"	4-5/16"	40
75227	31/64"x5-7/8"	4-3/8"	40
75228	1/2"x6"	4-1/2"	30

INDUSTRIAL

15PCS HSS FRACTIONAL JOBBER LENGTH DRILL BITS SET

- HSS/M2, ASME B.94.11M
- 135° Split point
- Packing: plastic case with double blister



STOCK NO.	SIZE	QTY./CARTON
75100	1/16"-1/16"-5/64"-3/32"-3/32"-7/64"-1/8"-1/8"-9/64"-5/32"-3/16"-7/32"-1/4"-5/16"-3/8"	24

WOOD DRILL BIT

- Special tool steel
- DIN338
- Hardened and tempered
- Black finished with polished surface
- Packing: skin card



STOCK NO.	SIZE	QTY./CARTON
75600	3x61mm	100
75601	4x75mm	100
75602	5x86mm	100
75603	6x93mm	100
75604	7x109mm	80
75605	8x117mm	80
75606	9x125mm	80
75607	10x133mm	80
75608	11x142mm	60
75609	12x151mm	60
75610	13x151mm	60

5PCS WOOD DRILL BITS SET

- Special tool steel
- DIN338
- Hardened and tempered
- Black finished with polished surface
- Packing: plastic box



STOCK NO.	SIZE	QTY./CARTON
75625	4, 5, 6, 8, 10mm	80

8PCS WOOD DRILL BITS SET

- Special tool steel
- DIN338
- Hardened and tempered
- Black finished with polished surface
- Packing: plastic box



STOCK NO.	SIZE	QTY./CARTON
75626	3, 4, 5, 6, 7, 8, 9, 10mm	60

16PCS DRILL BITS SET

- 6pcs HSS TWIST drill bits: 2.0, 3.0, 4.0, 5.0, 6.0, 8.0 mm
- 5pcs wood drill bits: 4.0, 5.0, 6.0, 8.0, 10.0 mm
- 5pcs masonry drill bits: 4.0, 5.0, 6.0, 8.0, 10.0 mm
- Packing: plastic box with double blister



STOCK NO.	QTY./CARTON
75628	24

TITANIUM DRILL BIT

- HSS/M2, DIN338
- Fully ground
- Titanium coated surface
- 135° split point
- 1/4" quick release hex shank
- Packing: blister card



STOCK NO.	SIZE	QTY./CARTON
75180	3x81mm	80
75181	3.2x85mm	80
75182	3.5x90mm	80
75183	4x95mm	80
75184	4.2x95mm	80
75185	4.5x100mm	80
75186	4.8x106mm	80
75187	5x106mm	80
75188	5.5x113mm	80
75189	6x113mm	80
75190	6.5x121mm	60
75191	7x109mm	60
75192	8x117mm	60
75193	9x125mm	60
75194	10x133mm	60

FLAT WOOD BITS

- Special tool steel hardened and tempered
- Precision polished
- With 1/4" quick release hex shank
- Total length: 152mm
- Packing: blister card



STOCK NO.	SIZE	QTY./CARTON
75631	6mm	180
75632	8mm	180
75633	10mm	180
75634	12mm	180
75635	13mm	180
75636	14mm	180
75637	16mm	180
75638	18mm	180
75639	19mm	180
75640	20mm	180
75641	22mm	180
75642	24mm	180
75643	25mm	180
75644	28mm	180
75645	30mm	180
75646	32mm	180
75647	35mm	180
75648	36mm	180
75649	38mm	180
75650	40mm	180

6PCS FLAT WOOD BITS SET

- Carbon steel hardened and tempered
- Precision polished
- With 1/4" quick release hex shank
- Total length: 152mm
- Packing: double blister



STOCK NO.	SIZE	QTY./CARTON
75656	3/8" - 1/2" - 5/8" - 3/4" - 7/8" - 1"	36

6PCS FLAT WOOD BITS SET

- Carbon steel hardened and tempered
- Precision polished
- With 1/4" quick release hex shank
- Total length:152mm
- Packing: double blister



STOCK NO.	SIZE	QTY./CARTON
75655	10,12,16,18,20,25mm	36

FORSTNER DRILL BIT

- TCT blade
- One-piece forged body
- Packing: plastic box with color label

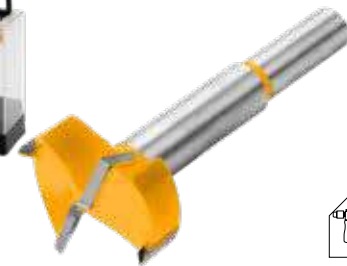

STOCK NO.	SIZE	LENGTH	SHANK	QTY./CARTON
75654	Ø35mm	85mm	Ø10mm	80

TILE AND GLASS DRILL BIT

- High quality carbide tip
- Special tool steel shank
- Sand blasting finished surface
- Packing: blister card



STOCK NO.	SIZE	QTY./CARTON
75690	3mm	100
75691	4mm	100
75692	5mm	100
75693	6mm	100
75694	7mm	100
75695	8mm	100
75696	9mm	100
75697	10mm	100
75699	12mm	100

5PCS GLASS DRILL BITS SET

- High quality carbide tip
- #45 carbon steel shank
- Sand blasting finished surface
- Packing: plastic case with color label



STOCK NO.	SIZE	QTY./CARTON
75688	4,5,6,8,10mm	80

TCT HOLE SAW

- 3-ply cutters reduces tip crack even with hard use
- Special Carbide tip can drilling the Stainless Steel sheet smoothly and nicely
- Long life working of the hardened steel
- Apply on portable and pillar drilling machines
- Packing: plastic box with color label



STOCK NO.	SIZE	QTY./CARTON
75914	14mm	80
75915	15mm	80
75920	20mm	80
75922	22mm	80
75923	23mm	80
75925	25mm	80
75926	26mm	80
75930	30mm	60
75932	32mm	60
75935	35mm	60
75938	38mm	60
75940	40mm	60
75942	42mm	40
75945	45mm	40
75948	48mm	40
75950	50mm	40
75955	55mm	40
79560	60mm	40
75965	65mm	30
75970	70mm	30
75975	75mm	30

HOLE CORE BIT

- Heavy duty Blades
- 1pc SDS plus adaptor:110mm
- 1pc Pilot drill bit: 8x120mm
- 1pc bolt: M6x14mm
- Thread size: M22
- Packed in color box

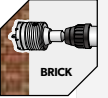
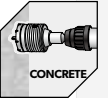

STOCK NO.	SIZE	QTY./CARTON
75890	50mm(2")x6T	24
75891	65mm(2-9/16")x8T	20
75894	80mm(3-1/8")x10T	16
75896	100mm(4")x12T	12

FLAT CUTTING-OFF WHEEL (TYPE 41)

- For metal & stainless steel



80 M/S

EN 12413



STOCK NO.	SIZE	MAX. RPM	QTY./CARTON
76131	100x1.0x16mm 4"x1/25"x5/8"	15,300	400
76132	115x1.0x22.2 mm 4-1/2" x 1/25" x 7/8"	13,300	400
76133	125x1.0x22.0 mm 5" x 1/25" x 7/8"	12,250	400
76134	115x1.6x22.2mm 4-1/2"x1/16"x7/8"	13,300	400
76101	105x1.2x16mm 4"x3/64"x5/8"	15,300	400
76102	115x1.2x22.2mm 4-1/2"x3/64"x7/8"	13,300	400
76103	125x1.2x22.2mm 5"x3/64"x7/8"	12,250	400
76105	180x1.6x22.2mm 7"x1/16"x7/8"	8,500	200
76107	230x2.0x22.2mm 9"x1/12"x7/8"	6,650	100
76120	350x3.2x25.4mm 14"x1/8"x1"	4,400	25

DEPRESSED CENTRE CUTTING-OFF WHEEL (TYPE 42)

- For metal



80 M/S

EN 12413



STOCK NO.	SIZE	MAX. RPM	QTY./ CARTON
76141	100x3.0x16.0mm 4"x1/8"x5/8"	15,300	200
76142	115x3.0x22.2mm 4-1/2"x1/8"x7/8"	13,300	200
76143	125x3.0x22.2mm 5"x1/8"x7/8"	12,250	200
76145	180x3.0x22.2mm 7"x1/8"x7/8"	8,500	100
76147	230x3.0x22.2mm 9"x1/8"x7/8"	6,650	50

DEPRESSED CENTRE GRINDING WHEEL (TYPE 27)

- For metal



80 M/S

EN 12413



STOCK NO.	SIZE	MAX. RPM	QTY./ CARTON
76301	100x6.0x16.0mm 4"x1/4"x5/8"	15,300	100
76302	115x6.0x22.2mm 4-1/2"x1/4"x7/8"	13,300	100
76303	125x6.0x22.2mm 5"x1/4"x7/8"	12,250	100
76305	180x6.0x22.2mm 7"x1/4"x7/8"	8,500	50
76307	230x6.0x22.2mm 9"x1/4"x7/8"	6,650	30

TCT SAW BLADE

- Suitable for wood cutting
- Packing: double blister



STOCK NO.	SIZE	ADJUSTING WASHER	QTY./ CARTON
76410	110mm(4-3/8") x 40T x 20mm	16mm	100
76419	115mm(4-1/2") x 24T x 22.2mm	16mm	100
76420	115mm(4-1/2") x 40T x 22.2mm	16mm	100
76425	160mm x 24T x 20mm	16mm	50
76426	160mm x 40T x 20mm	16mm	50
76430	185mm(7-1/4") x 24T x 30mm	16/20 / 22.2 / 25.4mm	50
76431	185mm(7-1/4") x 40T x 30mm	16/20 / 22.2 / 25.4mm	50
76432	185mm(7-1/4") x 60T x 30mm	16/20/22.2/ 25.4mm	50
76440	210mm(8-1/4") x 24T x 30mm	16/20 / 22.2 / 25.4mm	50
76441	210mm(8-1/4") x 48T x 30mm	16/20 / 22.2 / 25.4mm	50
76450	235mm(9-1/4") x 40T x 30mm	16/20 / 22.2 / 25.4mm	25
76451	235mm(9-1/4") x 60T x 30mm	16/20 / 22.2 / 25.4mm	25
76460	254mm(10") x 40T x 30mm	16/20 / 22.2 / 25.4mm	25
76461	254mm(10") x 60T x 30mm	16/20 / 22.2 / 25.4mm	25
76470	305mm(12") x 60T x 30mm	16/20 / 22.2 / 25.4mm	10
76171	305mm(12") x 80T x 30mm	16/20 / 22.2 / 25.4mm	10
76176	355mm(14") x 80T x 30mm	16/20 / 22.2 / 25.4mm	10

TCT SAW BLADE FOR ALUMINIUM

- Suitable for aluminium cutting
- Packing: double blister



ADJUSTING WASHER INCLUDED

STOCK NO.	SIZE	ADJUSTING WASHER	QTY./ CARTON
76540	210mm(8-1/4") x 60T x 30mm	16/ 20 / 22.2 / 25.4mm	50
76560	254mm(10") x 80T x 30mm	16/ 20 / 22.2 / 25.4mm	25
76561	254mm(10") x 100T x 30mm	16/ 20 / 22.2 / 25.4mm	25
76570	305mm(12") x 100T x 30mm	16/ 20 / 22.2 / 25.4mm	10
76571	305mm(12") x 120T x 30mm	16/ 20 / 22.2 / 25.4mm	10

DRY DIAMOND DISC

- Packing: color box



EN 13236

80 M/S



ADJUSTING WASHER INCLUDED

STOCK NO.	SIZE	BLADE WIDTH	MAX. RPM	QTY./ CARTON
76700	100X20(16)mm 4"x5/8"	7.5mm	15,300	100
76702	115X22.2 (20)mm 4-1/2"x7/8"	10mm	13,300	100
76703	125X22.2 (20)mm 5"x7/8"	10mm	12,250	100
76705	180X22.2 (20)mm 7"x7/8"	10mm	8,500	40
76707	230X22.2 (20)mm 9"x7/8"	10mm	6,650	20

INDUSTRIAL

WET DIAMOND DISC

- Wet cutting
- Packing: color box



INDUSTRIAL

EN 13236
 80 M/S

ADJUSTING WASHER INCLUDED

STOCK NO.	SIZE	BLADE WIDTH	MAX. RPM	QTY./ CARTON
76720	100X20(16)mm 4"x5/8"	7.5mm	15,300	100
76722	115X22.2 (20)mm 4-1/2"x7/8"	7.5mm	13,300	100
76723	125X22.2 (20)mm 5"x7/8"	7.5mm	12,250	100
76725	180X22.2 (20)mm 7"x7/8"	7.5mm	8,500	40
76727	230X22.2 (20)mm 9"x7/8"	7.5mm	6,650	20

TURBO DIAMOND DISC

- Dry and wet cutting
- Packing: color box



INDUSTRIAL

EN 13236
 80 M/S

ADJUSTING WASHER INCLUDED

STOCK NO.	SIZE	BLADE WIDTH	MAX. RPM	QTY./ CARTON
76740	100X20(16)mm 4"x5/8"	7mm	15,300	100
76742	115X22.2 (20)mm 4-1/2"x7/8"	10mm	13,300	100
76743	125X22.2 (20)mm 5"x7/8"	10mm	12,250	100
76745	180X22.2 (20)mm 7"x7/8"	10mm	8,500	40
76747	230X22.2 (20)mm 9"x7/8"	10mm	6,650	20

DRY DIAMOND DISC

- Dry cutting
- Packing: color sleeve



BASIC

80 M/S

ADJUSTING WASHER INCLUDED

STOCK NO.	SIZE	BLADE WIDTH	MAX. RPM	QTY./ CARTON
76710	100X16mm 4"x5/8"	6mm	15,300	100
76712	115X22.2 (20)mm 4-1/2"x7/8"	7mm	13,300	100
76713	125X22.2 (20)mm 5"x7/8"	7mm	12,250	100
76715	180X22.2 (20)mm 7"x7/8"	7mm	8,500	40
76717	230X22.2 (20)mm 9"x7/8"	7mm	6,650	20

WET DIAMOND DISC

- Wet cutting
- Packing: color sleeve



BASIC

80 M/S

ADJUSTING WASHER INCLUDED

STOCK NO.	SIZE	BLADE WIDTH	MAX. RPM	QTY./ CARTON
76730	100X16mm 4"x5/8"	5mm	15,300	100
76732	115X22.2 (20)mm 4-1/2"x7/8"	5mm	13,300	100
76733	125X22.2 (20)mm 5"x7/8"	5mm	12,250	100
76735	180X22.2 (20)mm 7"x7/8"	5mm	8,500	40
76737	230X22.2 (20)mm 9"x7/8"	5mm	6,650	20

TURBO DIAMOND DISC

- Dry and wet cutting
- Packing: color box



BASIC

80 M/S

ADJUSTING WASHER INCLUDED

STOCK NO.	SIZE	BLADE WIDTH	MAX. RPM	QTY./ CARTON
76760	100X16mm 4"x5/8"	7mm	15,300	100
76762	115X22.2 (20)mm 4-1/2"x7/8"	7mm	13,300	100
76763	125X22.2 (20)mm 5"x7/8"	7mm	12,250	100
76765	180X22.2 (20)mm 7"x7/8"	7mm	8,500	40
76767	230X22.2 (20)mm 9"x7/8"	7mm	6,650	20

ULTRATHIN DIAMOND DISC

- Ideal for brick, plaster, tile-special
- Packing: double blister



INDUSTRIAL

80 M/S

ADJUSTING WASHER INCLUDED

STOCK NO.	SIZE	BLADE SIZE	MAX. RPM	QTY./ CARTON
76750	105x20(16)mm 4"x25/32"	1.4x8mm	15,300	100
76751	115x22.2 (20)mm 4-1/2"x7/8"	1.2x8mm	13,300	100
76752	125x22.2 (20)mm 5"x7/8"	1.4x8mm	12,250	100
76753	180x22.2 (20)mm 7"x7/8"	1.6x8mm	8,500	40
76754	230x22.2 (20)mm 9"x7/8"	1.8x8mm	6,650	20

ULTRATHIN DIAMOND DISC

- Ideal for brick, plaster, tile-special
- Longer using life
- Packing: double blister



INDUSTRIAL



80
M/S



ADJUSTING WASHER INCLUDED

STOCK NO.	SIZE	BLADE SIZE	MAX. RPM	QTY./ CARTON
76756	115x22.2 (20)mm 4-1/2"x7/8"	1.2x8mm	13,300	100
76757	125x22.2 (20)mm 5"x7/8"	1.2x8mm	12,250	100
76759	230x22.2 (20)mm 9"x7/8"	1.2x8mm	6,650	20

SEGMENTED TURBO CUP GRINDING WHEEL

- Blade size:20x5mm



EN
13236

80
M/S



ADJUSTING WASHER INCLUDED

STOCK NO.	SIZE	MAX. RPM	QTY./ CARTON
76680	100x22.2 (20)mm 4"x7/8"	15,300	20
76681	115x22.2 (20)mm 4-1/2"x7/8"	13,300	20
76682	125x22.2 (20)mm 5"x7/8"	12,250	20

DOUBLE ROW SEGMENTED TURBO CUP GRINDING WHEEL

- Packing: color box



EN
13236

80
M/S



ADJUSTING WASHER INCLUDED

STOCK NO.	SIZE	MAX. RPM	QTY./ CARTON
76683	100x22.2 (20)mm 4"x7/8"	15,300	20
76684	115x22.2 (20)mm 4-1/2"x7/8"	13,300	20
76685	125x22.2 (20)mm 5"x7/8"	12,250	20

5PCS MOUNTED STONES SET

- 3pcs brown aluminum oxide
- 1pc pink aluminum oxide
- 1pc white aluminum
- Packing: blister card



STOCK NO.	SHANK SIZE	MAX. RPM	QTY./ CARTON
77110	Ø6.35x27mm	23,000	100

250PCS ACCESSORY SET FOR MINI DRILL

- Suitable for TOLSEN 79555
- 76pcs Cutting disk
- 60pcs Sanding paper
- 1pcs Rubber grinding wheel
- 10pcs Grinding wheel with shank
- 4pcs Rubber polishing wheel
- 5pcs Felt wheels
- 1pcs Felt wheel point
- 1pcs Cloth wheel
- 39pcs Sanding band
- 6pcs Brush
- 7pcs Diamond bits
- 2pcs Engraving bit
- 4pcs mandrel bits
- 2pcs Sanding shank
- 6pcs Hss drill bits
- 4pcs Collets
- 1pcs Flap wheel
- 1pcs Wrench
- 1pcs Dressing stone
- 2pcs Polishing Compound
- 12pcs Gringing wheels
- 5pcs Cut off wheels fiberglass
- Packing: plastic box with color label



STOCK NO.	SIZE	QTY./CARTON
77115	250PCS	6

CUP WIRE BRUSH WITH NUT

- Ideal for removing rust, paint and varnish from metal surfaces
- Wire dia:0.3mm
- Packing: double blister



INDUSTRIAL

EN
1083



STOCK NO.	SIZE	THREAD	MAX. RPM	QTY./CARTON
77600	75mm	M10x1.5	12,500	48
77601	75mm	M14x2	12,500	48
77602	100mm	M14x2	8,500	36
77603	125mm	M14x2	6,500	24
77605	3"	5/8"-11	12,500	48
77606	4"	5/8"-11	8,500	36
77607	5"	5/8"-11	6,500	24

CUP TWIST WIRE BRUSH WITH NUT

- Ideal for removing rust, paint and varnish from metal surfaces
- Wire dia:0.5mm
- Packing: double blister



NEW



INDUSTRIAL

EN
1083



STOCK NO.	SIZE	THREAD	MAX. RPM	QTY./ CARTON
77610	75mm	M10x1.5	12,500	48
77611	75mm	M14x2	12,500	48
77612	100mm	M14x2	8,500	36
77613	125mm	M14x2	6,500	24
77615	3"	5/8"-11	12,500	48
77616	4"	5/8"-11	8,500	36
77617	5"	5/8"-11	6,500	24

CUP TWIST WIRE BRUSH WITH NUT (HEAVY DUTY)

- Ideal for removing rust, paint and varnish from metal surfaces
- Wire dia: 0.5mm
- Thread: M14x2
- Packing: double blister



NEW



INDUSTRIAL

EN
1083



STOCK NO.	SIZE	MAX. RPM	QTY./ CARTON
77621	75mm	8,500	36
77622	100mm	8,500	16

CRIMPED WIRE BEVEL BRUSH

- Ideal for removing rust, paint and varnish from metal surfaces
- Wire dia:0.3mm
- Packing: double blister



NEW



INDUSTRIAL

EN
1083



STOCK NO.	SIZE	THREAD	MAX. RPM	QTY./ CARTON
77626	100mm	M10x1.5	12,500	40
77627	100mm	M14x2	12,500	40

TWIST WIRE BEVEL BRUSH

- Ideal for removing rust, paint and varnish from metal surfaces
- Wire dia:0.5mm
- Thread:M14x2
- Packing:double blister



NEW



EN 1083



STOCK NO.	SIZE	MAX. RPM	QTY./ CARTON
77629	100mm	12,500	48

INDUSTRIAL

CIRCULAR GRINDING WIRE BRUSH WITH SHANK

- Ideal for removing rust, paint and varnish from metal surfaces
- Wire dia:0.3mm
- Shank dia:6.35mm(1/4")
- Packing: blister card



EN 1083



STOCK NO.	SIZE	MAX. RPM	QTY./ CARTON
77540	50mm	4,500	80
77542	75mm	4,500	80
77543	100mm	4,500	72

INDUSTRIAL

5PCS WIRE BRUSHES SET

- 1" wire end brushes with shank
- 2"-3" circular grinding wire brush with shank
- 2"-3" cup brush with shank
- Wire dia:0.3mm
- Shank dia:6.35mm(1/4")
- Packing: blister card



EN 1083



STOCK NO.	SIZE	QTY./CARTON
77552	5PCS	24

INDUSTRIAL

CIRCULAR WIRE BRUSH

- Ideal for removing rust, paint and varnish from metal surfaces
- Wire dia:0.3mm
- Arbor size:22.2mm
- With rings: 13-16-19mm (1/2"-5/8"-3/4")
- Packing: double blister



NEW



EN 1083



STOCK NO.	SIZE	MAX. RPM	QTY./ CARTON
77630	125mm	3,750	60

INDUSTRIAL

WIRE END BRUSH WITH SHANK

- Ideal for removing rust, paint and varnish from metal surfaces
- Wire dia:0.3mm
- Shank dia:6.35mm(1/4")
- Packing: blister card



EN 1083



STOCK NO.	SIZE	MAX. RPM	QTY./ CARTON
77546	24mm	4,500	120

INDUSTRIAL

5PCS WIRE BRUSHES SET

- 1" wire end brushes with shank
- 2"-3" circular grinding wire brush with shank
- 2"-3" cup brush with shank
- wire dia:0.3mm
- Quick release hex shank: 1/4"
- Packing: blister card



EN 1083



STOCK NO.	SIZE	QTY./CARTON
77553	5PCS	24

INDUSTRIAL

CIRCULAR GRINDING WIRE BRUSH

- Ideal for removing rust, paint and varnish from metal surfaces
- Wire dia:0.5mm
- Arbor size:22.2mm
- Packing: double blister



NEW



EN 1083



STOCK NO.	SIZE	MAX. RPM	QTY./ CARTON
77633	125mm	11,000	48
77634	150mm	9,000	24
77635	180mm	7,000	24

INDUSTRIAL

CUP BRUSH WITH SHANK

- Ideal for removing rust, paint and varnish from metal surfaces
- Wire dia:0.3mm
- Shank dia:6.35mm(1/4")
- Packing: blister card



EN 1083



STOCK NO.	SIZE	MAX. RPM	QTY./ CARTON
77548	50mm	4,500	80
77550	75mm	4,500	80

INDUSTRIAL

3PCS DRILL BRUSH SET

- Include brush sizes: 2" (5cm), 3-1/2"(8.9cm), 4" (10cm)
- 1/4" quick change hex shank
- Ideal for use on cordless drills or impact drivers
- Durable ultra stiff bristles
- Clean a variety of surfaces including siding, brick, grills boats, car wheels, loose paint dirt etc.
- Packing: double blister



EN 1083



STOCK NO.	SIZE	QTY./CARTON
77554	3PCS	18

INDUSTRIAL

PLASTIC BACKING PAD WITH VELCRO

- Material: PP + EVA
- With a shank
- Packing: polybag with paper hanger



STOCK NO.	SIZE	THREAD	SHANK DIA.	QTY./ CARTON
77260	115mm	M14x2	8mm	100
77261	125mm	M14x2	8mm	100
77262	150mm	M14x2	8mm	60

ALUMINIUM OXIDE FLAP DISC (FIBRE BACKING) (TYPE 29)

- For steel and wood
- Packing: color label with color box

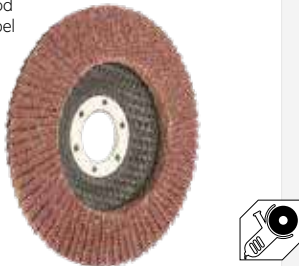

STOCK NO.	GRIT	SIZE	MAX. RPM	QTY./ CARTON
77201	40#	100x16mm	15,300	160
77202	60#	100x16mm	15,300	160
77203	80#	100x16mm	15,300	160
77205	120#	100x16mm	15,300	160
77211	40#	115x22.2mm	13,300	160
77212	60#	115x22.2mm	13,300	160
77213	80#	115x22.2mm	13,300	160
77215	120#	115x22.2mm	13,300	160
77221	40#	125x22.2mm	12,250	160
77222	60#	125x22.2mm	12,250	160
77223	80#	125x22.2mm	12,250	160
77225	120#	125x22.2mm	12,250	160

ZIRCONIA OXIDE FLAP DISC (FIBRE BACKING) (TYPE 29)

- For stainless steel
- Packing: color label with color box



STOCK NO.	GRIT	SIZE	MAX. RPM	QTY./ CARTON
77301	40#	100x16mm	15,300	160
77302	60#	100x16mm	15,300	160
77303	80#	100x16mm	15,300	160
77305	120#	100x16mm	15,300	160
77311	40#	115x22.2mm	13,300	160
77312	60#	115x22.2mm	13,300	160
77313	80#	115x22.2mm	13,300	160
77315	120#	115x22.2mm	13,300	160
77321	40#	125x22.2mm	12,250	160
77322	60#	125x22.2mm	12,250	160
77323	80#	125x22.2mm	12,250	160
77325	120#	125x22.2mm	12,250	160

5PCS SANDING SHEET FOR RANDOM ORBITAL SANDER

- Size: 125mm / 5"
- Suitable for TOLSEN 79565, 79761
- Ideal for metal, wood and paint
- High quality fibre backed for multiple using times
- Packing: color bag



STOCK NO.	SIZE	GRIT	QTY./ CARTON
77231	125mm / 5"	40#	200
77232	125mm / 5"	60#	200
77233	125mm / 5"	80#	200
77234	125mm / 5"	120#	200
77235	125mm / 5"	150#	200
77236	125mm / 5"	180#	200
77237	125mm / 5"	240#	200

5PCS SANDING SHEET FOR PALM DETAIL SANDER

- Size: 102x151mm / 4"x6"
- Suitable for TOLSEN 79561
- Ideal for metal, wood and paint
- High quality fibre backed for multiple using times
- Packing: color bag



STOCK NO.	SIZE	GRIT	QTY./ CARTON
77241	102x151mm / 4"x6"	40#	100
77242	102x151mm / 4"x6"	60#	100
77243	102x151mm / 4"x6"	80#	100
77244	102x151mm / 4"x6"	120#	100
77245	102x151mm / 4"x6"	150#	100
77246	102x151mm / 4"x6"	180#	100
77247	102x151mm / 4"x6"	240#	100

12PCS CARBIDE ROUTER BITS SET

- Core box bit: DIA-12.7,R-6.3
- Cove bit: DIA-22,R-6.3
- Dovetail bit: DIA-12.7,ANGLE-14
- 45° chamfer bit: DIA-32,ANGLE-45
- Flush trim bit: DIA-12.7
- Straight bit: DIA-16
- Round over bit: DIA-22,R-6.3
- Straight bit: DIA-12
- Straight bit: DIA-6
- Round over bit: DIA-28.6,R-9.5
- 90°"V" grooving bit: DIA-12.7,ANGLE-90
- Roman ogee bit: DIA-25,R-4
- Shank: 1/4"
- Packing: color box



1/4"

STOCK NO.	SIZE	QTY./CARTON
75680	1/4"	20

15PCS CARBIDE ROUTER BITS SET

- Straight bits: 3, 6, 12, 16mm
- Flush trim bit: 1/2"
- Dovetail bit: 1/2"
- Mortising bit: 1/2"
- 45° Chamfer bit: 32mm
- Cove box bit: 1/2", 1/4"
- Corner round bit: 22.2, 28.6mm
- Roman ogee bit: 25.4mm
- V grooving bit: 1/2"
- Cove bit: 22.2mm
- Shank: 8mm
- Packing: color box



STOCK NO.	SIZE	QTY./CARTON
75681	8mm	20

HOLE SAW

- Cutting depth:38mm
- HSS M3 Bi-metal
- Variable teeth 5TPI
- Packing: color box



STOCK NO.	DIAMETER	QTY./CARTON
75714	14mm,9/16"	100
75716	16mm,5/8"	100
75717	17mm,11/16"	100
75719	19mm,3/4"	100
75720	20mm,25/32"	100
75721	21mm,13/16"	100
75722	22mm,7/8"	100
75725	25mm,1"	100
75727	27mm,1-1/16"	100
75729	29mm,1-1/8"	100
75730	30mm,1-3/16"	100
75732	32mm,1-1/4"	100
75735	35mm,1-3/8"	100
75738	38mm,1-1/2"	100
75740	40mm,1-9/16"	100
75743	43mm,1-11/16"	100
75746	46mm,1-13/16"	50
75748	48mm,1-27/32"	50
75751	51mm,2"	50
75752	52mm,2-1/16"	50
75754	54mm,2-1/8"	50
75757	57mm,2-1/4"	50
75759	59mm,2-5/16"	50
75760	60mm,2-3/8"	50
75764	64mm,2-1/2"	50
75765	65mm,2-9/16"	50
75767	67mm,2-5/8"	50
75768	68mm,2-11/16"	50
75770	70mm,2-3/4"	50
75773	73mm,2-7/8"	50
75776	76mm,3"	50
75779	79mm,3-1/8"	50
75783	83mm,3-1/4"	50
75786	86mm,3-3/8"	50
75802	102mm,4"	25
75805	105mm,4-1/8"	25
75808	108mm,4-1/4"	25
75814	114mm,4-1/2"	10
75827	127mm,5"	10
75833	133mm,5-1/4"	10
75840	140mm,5-1/2"	10
75852	152mm,6"	10
75858	200mm,7-7/8"	6

9PCS BI-METAL HOLE SAW SET

- Ideal for electrical using purposes
- 6pcs Hole saw: 7/8"(22mm), 1-1/8"(29mm), 1-3/8"(35mm), 1-3/4"(44mm), 2"(51mm),2-1/2"(64mm)
- 2pcs Arbors: 3/8"(9.5mm)Hex shank arbor with HSS polid drill for 1/2" - 1-3/16"(14-30mm) hole saw 7/16"(11mm)Hex shank arbor with HSS polid drill for 1-1/4" - 8-17/64"(32-210mm) hole saw
- 1pc adapter
- Packed in blow mould case



STOCK NO.	QTY./CARTON
75860	10

9PCS BI-METAL HOLE SAW SET

- 6pcs hole saw: 3/4"(19mm), 7/8"(22mm), 1-1/8"(29mm), 1-1/2"(38mm), 1-3/4"(44mm), 2-1/4"(57mm)
- 2pcs Arbors: 3/8"(9.5mm) Hex shank arbor with HSS polid drill for 1/2"-1-3/16"(14-30mm) hole saw, 7/16"(11mm) Hex shank arbor with HSS polid drill for 1-1/4"-8-17/64"(32-210mm) hole saw
- 1pc adapter
- Packing: blow mould case



STOCK NO.	QTY./CARTON
75861	10

11PCS HOLE SAW SET

- 8pcs hole saw: 3/4"(19mm), 7/8"(22mm), 1-1/8"(29mm), 1-1/4"(32mm), 1-1/2"(38mm), 1-3/4"(44mm), 2"(51mm), 2-1/2"(64mm)
- 2pcs arbors
- 1pc hex key wrench:2.5mm
- Packing: blow mould case



STOCK NO.	QTY./CARTON
75865	30

8PCS HOLE SAW SET

- 5pcs hole saw: 2-1/2"(64mm), 3"(76mm), 3-1/2"(89mm), 4"(102mm), 5"(127mm)
- 1pc arbor
- 1pc hex key wrench:2.5mm
- 1pc driver plate
- Packing: blow mould case



STOCK NO.	QTY./CARTON
75866	20

16PCS HOLE SAW SET

- 12pcs hole saw: 19mm(3/4"), 22mm(7/8"), 29mm(1-1/8"), 32mm(1-1/4"), 38mm(1-1/2"), 44mm(1-3/4"), 51mm(2"), 64mm(2-1/2"), 76mm(3"), 89mm(3-1/2"), 102mm(4"), 127mm(5")
- 2pcs arbors 1/4" + 3/8"
- 1pc hex key wrench: 2.5mm
- 1pc driver plate
- Packing: blow mould case



STOCK NO.	QTY./CARTON
75867	20

11PCS DIAMOND CORE DRILL SET

- 5pcs diamond core drill: Ø38mm x 170mm, Ø52mm x 170mm, Ø65mm x 170mm, Ø117mm x 170mm, Ø127mm x 170mm
- 1pc SDS+ adaptor: 115mm
- 1pc SDS+ extension adaptor: 240mm
- 1pc hex adaptor: 12 x 88mm
- 1pc hex extension adaptor: 12 x 240mm
- 1pc centre drill: 10 x 200mm
- 1pc drift key: 6 x 50mm
- Packing: blow mould case with color sleeve



STOCK NO.	QTY./CARTON
75881	2

7PCS HOLE SAW SET

- Hole saw diameter: 26, 32, 38, 45, 50, 56, 63mm
- Packing: double blister



STOCK NO.	HEIGHT	QTY./CARTON
75869	25mm, 1"	60
75870	50mm, 2"	60

ARBOR FOR HOLE SAW

- M2 HSS twist drill bit with 135° split point, 1/4"x75mm
- Packing: double blister



STOCK NO.	SHANK SIZE	FIT HOLE SAW	QTY./CARTON
75700	3/8"	14-30mm	50

ARBOR FOR HOLE SAW

- M2 HSS twist drill bit with 135° split point, 1/4"x75mm
- Packing: double blister



STOCK NO.	SHANK SIZE	FIT HOLE SAW	QTY./CARTON
75701	7/16"	32-152mm	50

SDS-PLUS ARBOR FOR HOLE SAW

- M2 HSS twist drill bit with 135° split point, 1/4"x75mm
- Packing: double blister



STOCK NO.	FIT HOLE SAW	QTY./CARTON
75702	14-30mm	50

SDS-PLUS ARBOR FOR HOLE SAW

- M2 HSS twist drill bit with 135° split point, 1/4"x75mm
- Packing: double blister



STOCK NO.	FIT HOLE SAW	QTY./CARTON
75703	32-152mm	50

3PCS LOCK INSTALLATION HOLE SAW SET

- 1pc flat wood bit: 7/8"x6" / (22.2x152mm), with 1/4" quick release hex shank
- 1pc hole saw, diameter: 2-1/8" (54mm)
- 1pc arbor for hole saw
- Packing: double blister



STOCK NO.	QTY./CARTON
75868	60

4PCS LOCK INSTALLATION HOLE SAW SET

- 2pcs hole saw: 1"(25mm), 2-1/8"(54mm)
- Cutting depth of the hole saw: 50mm
- 1pc arbor for hole saw
- Shank size 3/8"(9.5mm)
- Size of the drill: 6x76mm
- ABS positioning plastic frame
- Adjustable thickness of the door from 1-3/8" to 1-3/4" (35-45mm)
- Adjustable of depth from 2-3/8" to 2-3/4" (60-70mm)
- Packing: double blister



STOCK NO.	QTY./CARTON
75863	20

INDUSTRIAL



TITANIUM COATED STEP DRILL BIT

- HSS, Hardened
- Titanium coating surface
- Packing: double blister

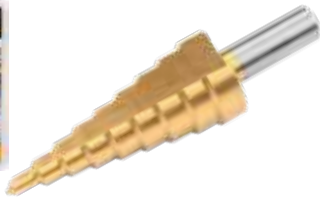

STOCK NO.	SIZE	QTY./CARTON
75871	4-12x2mm	80
75872	4-20x2mm	80
75873	4-32x2mm	40

3PCS TITANIUM COATED STEP DRILL BITS SET

- HSS, Hardened
- Titanium coating surface
- Packing: iron box with color sleeve



STOCK NO.	SIZE	QTY./CARTON
75878	4-12x2mm 4-20x2mm 4-32x2mm	20

TITANIUM COATED STEP DRILL BIT

- HSS, Hardened
- Titanium coating surface
- Packing: double blister

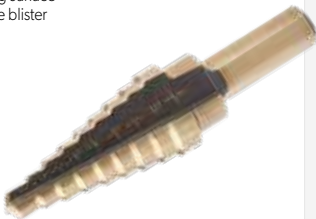

STOCK NO.	SIZE	QTY./CARTON
75875	1/8"-1/2" x 13 steps	80
75877	1/4"-3/4" x 9 steps	80

5PCS BLACK & GOLD STEP DRILL BITS SET

- HSS, Hardened
- Titanium coating surface
- Packing: aluminium case with color box



STOCK NO.	SIZE	QTY./CARTON
75879	1/4" - 1-3/8" x 10 steps 3/16" - 7/8" x 12 steps 1/4" - 3/4" x 9 steps 1/8" - 1/2" x 13 steps 3/16" - 1/2" x 6 steps	80

5PCS JIG SAW BLADE SET

- T111C
- T-Shank
- Material: HCS
- 8TPI
- Quick cutting for wood, chipboards, plywood, fibre boards, plastic
- Packing: sandwich paper card



x5

STOCK NO.	TOTAL LENGTH	QTY./CARTON
76801	100mm	200

5PCS JIG SAW BLADE SET

- T144D
- T-Shank
- Material: HCS
- 6TPI
- Fast straight cutting for wood, chipboards, plywood, fibre boards, plastic
- Packing: sandwich paper card



x5

STOCK NO.	TOTAL LENGTH	QTY./CARTON
76802	100mm	200

5PCS JIG SAW BLADE SET

- T244D
- T-Shank
- Material: HCS
- 6TPI
- Fast curved cutting for wood, chipboards, plywood, fibre boards, plastic
- Packing: sandwich paper card



x5

STOCK NO.	TOTAL LENGTH	QTY./CARTON
76803	100mm	200

5PCS JIG SAW BLADE SET

- T101B
- T-Shank
- Material: HCS
- 10TPI
- Fast clean and precise cutting for wood, chipboards, plywood, fibre boards, plastic
- Packing: sandwich paper card



x5

STOCK NO.	TOTAL LENGTH	QTY./CARTON
76804	100mm	200

10PCS RECIPROCATING SAW BLADE SET

- 4pcs 6"x19x1.27mm(6TPI), Material: 65Mn for wood cutting
- 2pcs 6"x19x1.27mm(10TPI), Material: 65Mn for wood cutting
- 2pcs 6"x19x0.92mm(18TPI), Material: HSS M2 for metal cutting
- 2pcs 8"x19x1.27mm(6TPI), Material: 65Mn for wood cutting
- Packing: double blister

NEW



x2pcs



x2pcs



x2pcs



x4pcs

STOCK NO.	SIZE	QTY./CARTON
76830	10PCS	48

x10

TOLSEN

GENERATORS

Keep The Power On



GASOLINE GENERATOR

3000W

230V~50Hz

- CE approval
- Rated output: 2800W
- Max. output power: 3000W
- Rated voltage: 230V
- Rated frequency: 50Hz
- Engine type: Single cylinder, 4-stroke, air-cooled
- Engine displacement: 212cc
- Ignition system: TCI
- Voltage regulator: AVR
- Starting system: Recoil
- Fuel tank capacity: 16L
- Continuous operating time: 10 hours
- Packing: color box



STOCK NO.	MAX. OUTPUT POWER	QTY./CARTON
79991	3000W	1



GASOLINE GENERATOR

5500W

230V~50Hz

- CE approval
- Rated output: 5000W
- Max. output power: 5500W
- Rated voltage: 230V
- Rated frequency: 50Hz
- Engine type: Single cylinder, 4-stroke, air-cooled
- Engine displacement: 420cc
- Ignition system: TCI
- Voltage regulator: AVR
- Starting system: Recoil/Electric
- Fuel tank capacity: 27L
- Continuous operating time: 9 hours
- Packing: color box



STOCK NO.	MAX. OUTPUT POWER	QTY./CARTON
79992	5500W	1



GASOLINE GENERATOR

8000W

230V~50Hz

- Rated output: 7500W
- Max. output power: 8000W
- Rated voltage: 230V
- Rated frequency: 50Hz
- Engine type: Single cylinder, 4-stroke, air-cooled
- Engine displacement: 460cc
- Ignition system: TCI
- Voltage regulator: AVR
- Starting system: Recoil/Electric
- Fuel tank capacity: 27L
- Continuous operating time: 9 hours
- Packing: color box



STOCK NO.	MAX. OUTPUT POWER	QTY./CARTON
79993	8000W	1



GASOLINE GENERATOR

3000W 110-120V/220-240V~60Hz

- Rated output: 2800W
- Max. output power: 3000W
- Rated voltage: 110-120V/220-240V
- Rated frequency: 60Hz
- Engine type: Single cylinder, 4-stroke, air-cooled
- Engine displacement: 212cc
- Ignition system: TCI
- Voltage regulator: AVR
- Starting system: Recoil
- Fuel tank capacity: 16L
- Continuous operating time: 10 hours
- Packing: color box



STOCK NO.	MAX. OUTPUT POWER	QTY./CARTON
79891	3000W	1

GASOLINE GENERATOR

5500W 110-120V/220-240V~60Hz

- Rated output: 5000W
- Max. output power: 5500W
- Rated voltage: 110-120V/220-240V
- Rated frequency: 60Hz
- Engine type: Single cylinder, 4-stroke, air-cooled
- Engine displacement: 420cc
- Ignition system: TCI
- Voltage regulator: AVR
- Starting system: Recoil/Electric
- Fuel tank capacity: 27L
- Continuous operating time: 9 hours
- Packing: color box



STOCK NO.	MAX. OUTPUT POWER	QTY./CARTON
79892	5500W	1

GASOLINE GENERATOR

8000W 110-120V/220-240V~60Hz

- Rated output: 7500W
- Max. output power: 8000W
- Rated voltage: 110-120V/220-240V
- Rated frequency: 60Hz
- Engine type: Single cylinder, 4-stroke, air-cooled
- Engine displacement: 460cc
- Ignition system: TCI
- Voltage regulator: AVR
- Starting system: Recoil/Electric
- Fuel tank capacity: 27L
- Continuous operating time: 9 hours
- Packing: color box



STOCK NO.	MAX. OUTPUT POWER	QTY./CARTON
79893	8000W	1

QUIET INVERTER GENERATOR

2000W

- CE approved
- Rated output: 1800W
- Max. output power: 2000W
- Rated voltage: 230V
- Rated frequency: 50Hz
- Engine type: Single cylinder, 4-stroke,
- OHV air-cooled
- Engine displacement: 80cc
- Ignition system: CDI
- DC output: 8.3A/12V
- Fuel tank capacity: 4L
- Continuous operating time (50% load): 6 hours
- Noise Level (50% load): <64dB
- Packing: color box



STOCK NO.	MAX. OUTPUT POWER	QTY./CARTON
79986	2000W	1



QUIET INVERTER GENERATOR

2400W

- Rated output: 2200W
- Max. output power: 2400W
- Rated voltage: 230V
- Rated frequency: 50Hz
- Engine type: Single cylinder, 4-stroke,
- OHV air-cooled
- Engine displacement: 100cc
- Ignition system: CDI
- DC output: 8.3A/12V
- Fuel tank capacity: 4L
- Continuous operating time (50% load): 5 hours
- Noise Level (50% load): <64dB
- Packing: color box



STOCK NO.	MAX. OUTPUT POWER	QTY./CARTON
79987	2400W	1

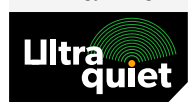

QUIET INVERTER GENERATOR

4000W

- CE approved
- Rated output: 3500W
- Max. output power: 4000W
- Rated voltage: 230V
- Rated frequency: 50Hz
- Engine type: Single cylinder, 4-stroke, OHV air-cooled
- Engine displacement: 225cc
- Ignition system: TCI
- DC output: 8.3A/12V
- Fuel tank capacity: 12.5L
- Continuous operating time (50% load): 8 hours
- Noise Level (50% load): 64dB
- Packing: color box



STOCK NO.	MAX. OUTPUT POWER	QTY./CARTON
79988	3500W	1



TOLSEN

CONSTRUCTION EQUIPMENT

SUPERIOR PERFORMANCE



GASOLINE PLATE COMPACTOR

- Weight: 60kgs
- Frequency:5600VPM
- Centrifugal force:10.5kN
- Compaction depth:20cm
- Travel speed:40cm/s
- Efficiency:450m²/hr
- Plate size:50x36cm
- Packing: carton box

6.5HP **Loncin** ENGINE **60kg**

5.5HP **GX160 HONDA** ENGINE **60kg**



STOCK NO.	ENGINE TYPE	POWER	WEIGHT	QTY./CARTON
86101	Loncin model	4.8Kw(6.5HP)	60kg	1
86102	Honda GX160	4.0Kw(5.5HP)	60kg	1

GASOLINE PLATE COMPACTOR

- Weight: 90kgs
- Frequency:4200VPM
- Centrifugal force:15kN
- Compaction depth:30cm
- Travel speed: 38cm/s
- Efficiency:660m²/hr
- Plate size:55x44cm
- Packing: carton box

6.5HP **Loncin** ENGINE **90kg**



5.5HP **GX160 HONDA** ENGINE **90kg**



STOCK NO.	ENGINE TYPE	POWER	WEIGHT	QTY./CARTON
86103	Loncin model	4.8Kw(6.5HP)	90kg	1
86104	Honda GX160	4.0Kw(5.5HP)	90kg	1

GASOLINE PLATE COMPACTOR

- Weight: 125kgs
- Frequency: 4300VPM
- Centrifugal force: 25kN
- Compaction depth: 30cm
- Travel speed: 25cm/s
- Efficiency: 500m²/hr
- Plate size: 63x40cm
- Packing: carton box



6.5HP	LONCIN ENGINE	 125kg
	GX160 HONDA ENGINE	 125kg



STOCK NO.	ENGINE TYPE	POWER	WEIGHT	QTY./CARTON
86109	Loncin model	4.8Kw(6.5HP)	125kg	1
86110	Honda GX160	4.0Kw(5.5HP)	125kg	1

GASOLINE TAMPING RAMMER

- Weight: 79kgs
- Impact force: 10kN
- Jumping stroke: 65mm
- Impact rate: 450-650vpm
- Plate size: 34.5x28.5cm
- Packing: carton box

6.5HP	LONCIN ENGINE	 79kg
	GX160 HONDA ENGINE	 79kg



STOCK NO.	ENGINE TYPE	POWER	WEIGHT	QTY./CARTON
86124	Loncin model	4.8Kw(6.5HP)	79kg	1
86125	Honda GX160	4.0Kw(5.5HP)	79kg	1

GASOLINE CONCRETE VIBRATOR

- Claw type coupling
- Not included vibrator poker
- Weight: 21.5kgs
- Packing: carton box



STOCK NO.	ENGINE TYPE	POWER	WEIGHT	QTY./CARTON
86141	Loncin model	4.8Kw(6.5HP)	21.5kg	1
86142	Honda GX160	4.0Kw(5.5HP)	21.5kg	1

VIBRATOR POKER

- Claw type fitting
- Head length:580mm
- Vibrating frequency:200Hz
- Vibrating amplitude:1.2mm
- Flexible hose length:6m
- Packing: carton box



Dynapac Type Coupling

STOCK NO.	DIAMETER	FLEXIBLE HOSE LENGTH	QTY./CARTON
86153	38mm	6m	1
86154	45mm	6m	1

GASOLINE POWER TROWEL

- Weight: 78.5kgs
- Rotor diameter:910mm(36")
- Blade number: 4 pieces (INCLUDED)
- Finish blade:350x150mm(6x14")
- Packing: carton box

910mm 36"



STOCK NO.	ENGINE TYPE	POWER	WEIGHT	ROTOR DIAMETER	QTY./CARTON
86161	Loncin model	4.8Kw(6.5HP)	78.5kg	910mm, 36"	1
86162	Honda GX160	4.0Kw(5.5HP)	78.5kg	910mm, 36"	1

GASOLINE CONCRETE CUTTER

- Engine power: 9.6Kw(13HP)
- Weight: 120kgs
- Maximum cutting depth: 140mm
- Cutting blade size: 300-450mm(12"-18")
- Blade not included
- Depth adjustment: handle rotation
- Driving: Manual push
- Water tank capacity: 35L
- Packing: carton box

300-450mm 12-18"

13HP



13HP



STOCK NO.	ENGINE TYPE	POWER	CUTTING BLADE SIZE	WEIGHT	QTY./CARTON
86183	Loncin model	9.6Kw(13HP)	300-450mm, 12"-18"	120kg	1
86184	Honda GX390	9.6Kw(13HP)	300-450mm, 12"-18"	120kg	1

GASOLINE CONCRETE MIXER

- Engine power: 4.8Kw(6.5HP)
- Drum volume: 350L
- Mixed batch output: 260L
- No load speed: 30rpm
- Maximum diameter of material: 3.5cm
- Packing: iron frame

350L

6.5HP



STOCK NO.	ENGINE TYPE	POWER	DRUM VOLUME	QTY./CARTON
86195	Loncin model	4.8Kw(6.5HP)	350L	1

TOLSEN AIRXT

POWERFUL PERFORMANCE

DRIVEN BY COMPRESSED AIR



AIR SPRAY GUN

- CE approval
- Type of feed: Gravity
- Air inlet: G1/4" male thread
- Packing: by color box

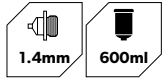

STOCK NO.	STAINLESS STEEL NOZZLE	AIR CONSUMPTION	OPERATING AIR PRESSURE	SPRAY FAN PATTERN	PAINT CAPACITY	QTY./ CARTON
73175	1.4mm	170L/min (6SCFM)	3.5-5Bar (50-70psi)	18-25cm	600ml	18

AIR SPRAY GUN

- CE approval
- Type of feed: Suction
- Air inlet: G1/4" male thread
- Packing: by color box



STOCK NO.	STAINLESS STEEL NOZZLE	AIR CONSUMPTION	OPERATING AIR PRESSURE	SPRAY FAN PATTERN	PAINT CAPACITY	QTY./ CARTON
73185	1.7mm	200L/min (7SCFM)	3.5-5Bar (50-70psi)	18-25cm	1000ml	10

AIR SPRAY GUN

- CE approval
- Type of feed: Gravity
- Air inlet: G1/4" male thread
- Packing: by color box

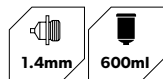
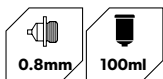

STOCK NO.	STAINLESS STEEL NOZZLE	AIR CONSUMPTION	OPERATING AIR PRESSURE	SPRAY FAN PATTERN	PAINT CAPACITY	QTY./ CARTON
73160	0.8mm	113L/min (4SCFM)	2.0-3.0Bar (30-43psi)	10-16cm	100ml	20
73170	1.4mm	170L/min (6SCFM)	2.0-3.5Bar (30-50psi)	18-25mm	600ml	18

AIR SPRAY GUN

- CE approval
- Type of feed: Suction
- Air inlet: G1/4" male thread
- Packing: by color box



STOCK NO.	STAINLESS STEEL NOZZLE	AIR CONSUMPTION	OPERATING AIR PRESSURE	SPRAY FAN PATTERN	PAINT CAPACITY	QTY./ CARTON
73180	1.7mm	170L/min (6SCFM)	2.5-3.5Bar (35-50psi)	18-25cm	1000ml	10

AIR WASHING GUN

- CE approval
- Operation pressure: 4bar
- Packed by color box



STOCK NO.	PAINT CAPACITY	QTY./CARTON
73191	1000ml	10

AIR TIRE INFLATING GUN

- CE approval
- Pistol-Grip with dial
- Dial reads 0-12 bar and 0-170 psi
- Suitable for use with motor vehicles, cycles, dinghies, etc
- Clip-on connector
- G1/4 threaded connectors
- Length: 40cm
- Packing: blister card



STOCK NO.	LENGTH	QTY./CARTON
73193	40cm	36

AIR BLOW GUN

- CE approval
- Suitable for cleaning liquid, swarf or dust during manufacture or assembly
- Nozzle length 25mm
- Packing: blister card



STOCK NO.	NOZZLE LENGTH	QTY./CARTON
73195	25mm	40

5PCS AIR TOOLS KIT

- CE approval
- 1pc Air spray gun: 600ml, Gravity feed
- 1pc Air blow gun: nozzle length 25mm
- 1pc Air washing gun: 1000ml, suction feed
- 1pc Air tire inflating gun: 0-12 bar and 0-170 psi ; 1/4" threaded connectors
- 1pc spiral air hose
- Packing: color box



STOCK NO.	SIZE	QTY./CARTON
73198		8

AIR HOSE

- CE approval
- Inner diameter: 6mm
- Outer diameter: 8mm
- Maximum working pressure: 10Bar (145psi)
- Hose connector: 1/4"
- Packing: shrink with color label



STOCK NO.	LENGTH	QTY./CARTON
73151	10m	25
73152	15m	25

AUTOMATIC AIR LINE HOSE REEL

- CE approval
- Oversize: 53x49x23cm
- Keep work space free from unwanted length of hose
- Working pressure: 10bar / 150psi
- Supplied with 15m+1.5m of PVC air line hose size 3/8"(9.5x15.8mm)
- Hose connection 1/4" BSPT male thread
- Max. working pressure of hose: 300psi
- Packing: color box



STOCK NO.	LENGTH	QTY./CARTON
73159	15M/50ft	1

1/2" AIR IMPACT WRENCH

- CE approved
- Square drive: 1/2"
- Twin hammer provides more torque and less vibration
- Operating air pressure: 6.2BAR (90PSI)
- Average air consumption: 120L/min (with 5-speed regulator)
- Air inlet: 1/4"
- Air hose: 3/8"
- Max. torque: 1000NM (735FT-LB)
- Free speed: 6000 rpm
- Net weight: 2.76KGS
- Packing: color box



STOCK NO.	SQUARE DRIVE	QTY./CARTON
73302	1/2"	6

1/2" AIR IMPACT WRENCH

- CE approved
- Square drive: 1/2"
- Twin hammer provides more torque and less vibration
- Operating air pressure: 6.2BAR (90PSI)
- Average air consumption: 120L/min (with 5-speed regulator)
- Air inlet: 1/4"
- Air hose: 3/8"
- Max. torque: 640NM (470FT-LB)
- Free speed: 7500 rpm
- Net weight: 2.8KGS
- Packing: color box



STOCK NO.	SQUARE DRIVE	QTY./CARTON
73301	1/2"	6

1" AIR IMPACT WRENCH

- CE approved
- Square drive: 1"
- Operating air pressure: 6.2BAR (90PSI)
- Average air consumption: 380L/min
- Air inlet : 1/2"
- Air hose: 1/2"
- Max. torque: 3200NM (2360FT-LB)
- Free speed: 3500 rpm
- Net weight: 16.56KGS
- Packing: color box

INDUSTRIAL



1"

3500 rpm

3200Nm (2360ft-lb)

FORWARD REVERSE

3 SPEED REGULATOR

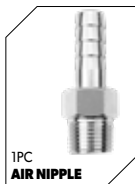
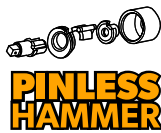

STOCK NO.	SQUARE DRIVE	QTY./CARTON
73395	1"	1

17PCS AIR IMPACT WRENCH SET

- 1pc 1/2" air impact wrench:
Operating air pressure: 6.2BAR (90PSI)
Average air consumption: 210L/min
Air inlet size: 3/8"
Max. torque: 340NM (250FT-LB)
Free speed: 7000 rpm
Net weight: 2.18KGS
- 10pcs impact sockets: 9, 10, 11, 13, 14, 17, 19, 22, 24, 27mm
- 1pc extension bar: 1/2"x 5"
- 1pc 4mm hex wrench
- 1pc oil can
- 1pc nipple
- 1pc grease injector
- 1pc 1/4" quick coupler, European type
- Packing: blow mould case with color sleeve



1/2"

7000 rpm

340Nm (250ft-lb)



STOCK NO.	SIZE	QTY./CARTON
73382	1/2"	4

9PCS AIR HAMMER SET (HEX)

- 1pc air hammer :
Operating air pressure: 6.2BAR (90PSI)
Operating length: 41mm
Average air consumption: 140L/min
Air inlet size: 3/8"
Impact rate: 4500 bpm
Net weight: 1.13KGS
- 4pcs hex shank chisels 125mm
- 1pc oil can
- 1pc nipple
- 1pc spring retainer
- 1pc 1/4" quick coupler, European type
- Packing: blow mould case with color sleeve



HEX

4500 bpm



STOCK NO.	SIZE	QTY./CARTON
73384		6

1/2" AIR RATCHET

- CE approved
- Square drive: 1/2"
- Operating air pressure: 6.2BAR (90PSI)
- Air consumption: 110L/min
- Air inlet: 1/4"
- Air hose: 3/8"
- Max. torque: 69NM(50FT-LB)
- Free speed: 160 rpm
- Net weight: 1.18KGS
- 1pc 1/4" quick coupler, European type
- Packing: color box



1/2"

160rpm

69Nm (50ft-lb)

FORWARD REVERSE



STOCK NO.	SQUARE DRIVE	QTY./CARTON
73315	1/2"	12

1/4" AIR DIE GRINDER

- CE approved
- Capacity: 1/4" , 6.35mm
- Operating air pressure: 6.2BAR (90PSI)
- Air consumption: 127L/min
- Air inlet: 1/4"
- Air hose: 3/8"
- Free speed: 22000 rpm
- Net weight: 0.6KGS
- 1pc 1/4" quick coupler, European type
- Packing: color box



22000 rpm

THROTTLE LEVER LOCK FOR SAFETY

1/4" (6.35mm)



STOCK NO.	SQUARE DRIVE	QTY./CARTON
73325	1/4", 6.35mm	20

2 IN 1 BRAD NAILER

- CE approval
- Suitable for brads:
 - F brads 18Ga. 1.26x1.05mm: 15-50mm
 - K brads 18Ga. 1.26x1.05mm: 16-40mm
- Magazine capacity: 100pcs
- Operating pressure: 70psi(0.5Mpa)-110psi(0.75Mpa)
- Air inlet: 1/4"
- Net weight: 1.3kg
- 360° adjustable exhaust
- Depth adjustable
- No-mar tip protects work surface
- Reload indicator
- Accessories:
 - 300pcs F brads
 - 300pcs K brads
 - 2pcs hex key
 - 1pc oil pot
 - 3pcs quick coupler with 1/4" PT male thread
- Packing: color box

INDUSTRIAL



18Ga

100 pcs
MAGAZINE CAPACITY

70psi
0.5Mpa
110psi
0.75Mpa



FBRADS	2mm (0.079")	K STAPLES	5.7mm (1/4")
15mm	5/8"	16mm	5/8"
20mm	3/4"	19mm	3/4"
25mm	1"	25mm	1"
30mm	1-3/16"	32mm	1-1/4"
32mm	3/8"	38mm	1-1/2"
35mm	1-3/8"	40mm	1-5/8"
38mm	1-1/2"		
40mm	1-5/8"		
45mm	1-3/4"		
50mm	2"		

18Ga
1.26x1.05mm
(0.050"x0.041")



STOCK NO.	QTY./CARTON
73420	6

AIR STAPLER

- CE approval
- Suitable for staples:
 - Crown staples 21Ga. 0.95*0.66mm: 6-16mm
- Magazine capacity: 120pcs
- Operating pressure: 60psi(0.4Mpa)-100psi(0.7Mpa)
- Air inlet: 1/4"
- Net weight: 0.8kg
- Ideal for upholstering, cabinet assembly, furniture manufacturing
- Accessories:
 - 300pcs Crown staples
 - 2pcs hex key
 - 1pc oil pot
 - 3pcs quick coupler with 1/4" PT male thread
- Packing: color box

INDUSTRIAL



21Ga

120 pcs
MAGAZINE CAPACITY

60psi
0.4Mpa
100psi
0.7Mpa



CROWN STAPLES	12.8mm (1/2")
4mm	5/32"
6mm	1/4"
8mm	5/16"
10mm	3/8"
12mm	1/2"
14mm	9/16"
16mm	5/8"

21Ga
0.95x0.66mm
(0.037"x0.026")



STOCK NO.	QTY./CARTON
73425	8

BRAD NAIL

- 18GA, 1.25x1.0mm
- Nail head: 2x1.25mm
- Galvanized surface
- Packing: 5000pcs in one color box

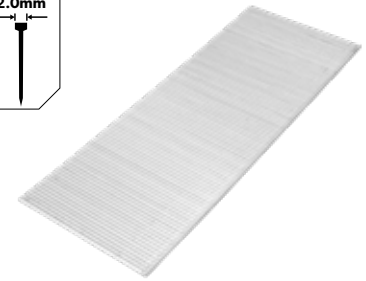
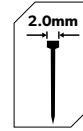

STOCK NO.	SIZE	QTY./CARTON
73443	25mm	10 boxes
73444	30mm	10 boxes
73445	32mm	10 boxes
73448	40mm	10 boxes
73449	50mm	10 boxes

CROWN STAPLE

- 18GA, 1.25x1.0mm
- Galvanized surface
- Packing: 5000pcs in one color box

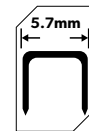

STOCK NO.	SIZE	QTY./CARTON
73455	25mm	6 boxes
73456	30mm	6 boxes
73457	35mm	6 boxes
73459	40mm	6 boxes

CROWN STAPLE

- 21GA, 0.9x0.65mm
- Galvanized surface
- Packing: 10000pcs in one color box

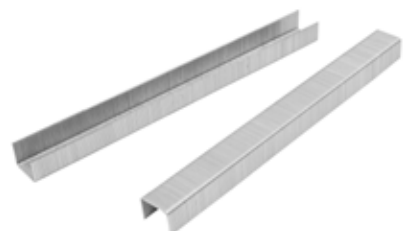
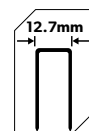

STOCK NO.	SIZE	QTY./CARTON
73462	10mm	10 boxes
73463	12mm	10 boxes
73464	14mm	10 boxes
73465	16mm	10 boxes

INDUSTRIAL

AIR COMPRESSOR

- Copper wire induction motor
- Input power: 2200W / 3Hp
- Rated Voltage: 220-240V
- Frequency: 50Hz
- Tank: 200L
- Air displacement: 370L/min
- Max pump pressure: 8Bar(116psi)
- Noise: 83db
- Belt driving system
- Pump lubricated with oil
- Packing: wood box

NEW

3HP 200L



STOCK NO.	SIZE	TANK	QTY./CARTON
73118	3Hp (2200W)	200L	1

AIR COMPRESSOR

- Copper wire induction motor
- Input power: 4100W / 5.5Hp
- Rated Voltage: 380V
- Frequency: 50Hz
- Tank: 300L
- Air displacement: 600L/min
- Max pump pressure: 8Bar(116psi)
- Noise: 83db
- Belt driving system
- Pump lubricated with oil
- Packing: wood box

NEW

5.5HP 300L



STOCK NO.	SIZE	TANK	QTY./CARTON
73119	5.5Hp (4100W)	300L	1

INDUSTRIAL

AIR COMPRESSOR

- CE approval
- Input power: 2200W / 3Hp
- Rated Voltage: 230V
- Frequency: 50HZ
- Air displacement: 250L/min
- Max pump pressure: 8Bar(116psi)
- Speed: 2850rpm
- Noise: 92db
- Belt driving system
- Pump lubricated with oil
- Features:
- Suitable for workshop use
- Thermal motor protection overload
- Pressure regulator and pressure gauge
- Wheels and transport handle
- Packing: wood box

3HP 100L



STOCK NO.	SIZE	TANK	QTY./CARTON
73130	3Hp (2200W)	100L	1

AIR COMPRESSOR

- Input power: 800W / 1Hp
- Rated Voltage: 230V
- Frequency: 50HZ
- Tank: 8L
- Air displacement: 188L/min
- Max pump pressure: 8Bar(116psi)
- Air outlet size: 1/4"
- Noise: 88db
- Belt driving system
- Pump lubricated with oil
- Features:
- Suitable for workshop use
- Thermal motor protection overload
- Pressure regulator and pressure gauge
- Packing: color box

1HP 8L



STOCK NO.	SIZE	TANK	QTY./CARTON
73122	1Hp (800W)	8L	1

AIR COMPRESSOR

- CE approval
- Input power: 1500W / 2Hp
- Rated Voltage: 220-240V
- Frequency: 50/60HZ
- Air displacement: 188L/min
- Max pump pressure: 8Bar(116psi)
- Speed: 2850rpm
- Noise: 92db
- Belt driving system
- Pump lubricated with oil
- Features:
- Suitable for workshop use
- Thermal motor protection overload
- Pressure regulator and pressure gauge
- Wheels and transport handle
- Packing: color box

2HP 50L 2HP 24L



STOCK NO.	SIZE	TANK	QTY./CARTON
73125	2Hp (1500W)	24L	1
73126	2Hp (1500W)	50L	1

AIR COMPRESSOR

- Input power: 800W / 1Hp
- Rated Voltage: 230V
- Frequency: 50HZ
- Tank: 24L
- Air displacement: 77L/min
- Max pump pressure: 8Bar(116psi)
- Air outlet size: 1/4"
- Noise: 60db
- Oil free system
- Features:
- Suitable for workshop use
- Thermal motor protection overload
- Pressure regulator and pressure gauge
- Wheels and transport handle
- Packing: color box

1HP 24L



STOCK NO.	SIZE	TANK	QTY./CARTON
73135	1Hp (800W)	24L	1

MALE STEEL INDUSTRIAL QUICK COUPLER G1/4"

- G 1/4"
- Maximum working pressure: 150psi
- High quality strength steel
- Couplers deliver longer life and higher performance
- It is built to handle the toughest jobs and withstand harsh working environments
- Packing: blister card

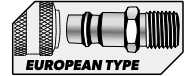

STOCK NO.	QTY./CARTON
72801	250

FEMALE STEEL INDUSTRIAL QUICK COUPLER G1/4"

- G 1/4"
- Maximum working pressure: 150psi
- High quality strength steel
- Couplers deliver longer life and higher performance
- It is built to handle the toughest jobs and withstand harsh working environments
- Packing: blister card



STOCK NO.	QTY./CARTON
72802	250

MALE STEEL INDUSTRIAL QUICK COUPLER G1/4"

- G 1/4"
- Maximum working pressure: 150psi
- High quality strength steel
- Couplers deliver longer life and higher performance
- It is built to handle the toughest jobs and withstand harsh working environments
- Packing: blister card



STOCK NO.	QTY./CARTON
72811	120

FEMALE STEEL INDUSTRIAL QUICK COUPLER G1/4"

- G 1/4"
- Maximum working pressure: 150psi
- High quality strength steel
- Couplers deliver longer life and higher performance
- It is built to handle the toughest jobs and withstand harsh working environments
- Packing: blister card



STOCK NO.	QTY./CARTON
72812	120



HARDWARE

ROOFING NAILS

- For applying roofing asphalt shingles, insulation board, and felt-to-wood substrates
- Large head and heavier shank gauge provide greater holding power
- Galvanized surface
- Packing: 1kg in a color box



STOCK NO.	SIZE	KG/BOX	BOXES/CARTON
54011	3.1x20mm	1	12
54012	3.1x25mm	1	12
54013	3.1x30mm	1	12

CONCRETE NAILS

- The surface is Galvanized, more effectively prevent nail corrosion.
- Suitable for high hardness cement wall, ground and other occasions vertical stripes on the surface increase friction.
- Packing: 1kg in a color box



STOCK NO.	SIZE	KG/BOX	BOXES/CARTON
54021	3.8x25mm	1	12
54022	3.8x40mm	1	12
54023	3.8x50mm	1	12
54024	3.8x65mm	1	12
54025	3.8x75mm	1	12
54026	4.0x100mm	1	12

STEEL NAILS

- Polished finish offers a decorative appearance
- Suitable for board, roof, pallet tray fixing, interior framing, carpentry, boxes, and general construction
- Packing: 1kg in a color box



STOCK NO.	SIZE	KG/BOX	BOXES/CARTON
54031	2.0X38mm	1	12
54032	2.8X51mm	1	12
54033	3.0X64mm	1	12
54034	3.75X76mm	1	12
54035	4.0X102mm	1	12
54036	4.5X127mm	1	12

DRYWALL SCREW

- Phillips drive
- Bugle head
- Fine thread
- Black phosphate finish
- Packing: color box



STOCK NO.	SIZE	PCS/BOX	BOXES/CARTON
54051	3.5x19mm	500	30
54052	3.5x25mm	500	30
54053	3.5x32mm	500	30
54054	3.5x38mm	500	18
54055	3.5x45mm	500	18
54056	3.5x50mm	500	18
54057	4.2x70mm	250	18
54058	4.2x80mm	250	18

CHIPBOARD SCREW

- Pozzi drive
- Deep and sharp thread
- Galvanized surface
- Packing: color box



STOCK NO.	SIZE	PCS/BOX	BOXES/CARTON
54066	3.5x25mm	500	30
54071	4.0x20mm	500	30
54072	4.0x25mm	500	30
54073	4.0x30mm	500	18
54074	4.0x40mm	500	18
54075	4.0x50mm	500	18
54086	5.0x50mm	250	18
54087	5.0x60mm	250	18
54088	5.0x70mm	200	18
54089	5.0x80mm	200	18

SELF-TAPPING SCREW

- Phillips drive
- Pan head
- Zinc plated surface
- For use in Sheet Metal Steel, Attaches Wire Lath to Metal Studs or Metal or Aluminum to Metal or Aluminum.
- Packing: color box



STOCK NO.	SIZE	PCS/BOX	BOXES/CARTON
54112	3.5x19mm	500	30
54113	3.5x25mm	500	30
54120	4.2x19mm	500	18
54121	4.2x25mm	250	30
54122	4.2x38mm	250	30
54127	4.8x38mm	250	18
54128	4.8x50mm	250	18

SELF-TAPPING SCREW

- Phillips drive
- Truss head
- Zinc plated surface
- For use in Sheet Metal Steel, Attaches Wire Lath to Metal Studs or Metal or Aluminum to Metal or Aluminum.
- Packing: color box



STOCK NO.	SIZE	PCS/BOX	BOXES/CARTON
54151	4.2x13mm	500	30
54152	4.2x19mm	500	18
54153	4.2x25mm	500	18

SELF DRILLING SCREW

- Phillips drive
- Truss head
- Zinc plated surface
- For use in Sheet Metal Steel, Attaches Wire Lath to Metal Studs or Metal or Aluminum to Metal or Aluminum.
- Packing: color box



STOCK NO.	SIZE	PCS/BOX	BOXES/CARTON
54161	4.2x13mm	500	30
54162	4.2x16mm	500	18
54163	4.2x19mm	500	18
54164	4.2x25mm	500	18
54165	4.2x32mm	500	18

COUNTERSUNK HEAD SELF DRILLING SCREW

- Phillips drive
- Flat head
- Zinc plated surface
- For use in Sheet Metal Steel, Attaches Wire Lath to Metal Studs or Metal or Aluminum to Metal or Aluminum.
- Packing: color box



STOCK NO.	SIZE	PCS/BOX	BOXES/CARTON
54171	3.9x19mm	500	30
54173	3.9x25mm	500	18
54174	3.9x32mm	500	18
54175	4.2x16mm	500	30
54176	4.2x19mm	500	30
54177	4.2x25mm	500	18
54178	4.2x32mm	500	18
54179	4.2x38mm	500	18
54180	4.8x25mm	500	18
54181	4.8x32mm	500	18
54182	4.8x38mm	500	18
54183	4.8x50mm	250	18

HEX SELF DRILLING SCREW WITH RUBBER WASHER

- External hex drive
- Flanged head
- Zinc plated surface
- For use in Sheet Metal Steel, Attaches Wire Lath to Metal Studs or Metal or Aluminum to Metal or Aluminum.
- Provides a leak proof seal making these screws excellent for roofing or siding applications.
- Packing: color box



STOCK NO.	SIZE	PCS/BOX	BOXES/CARTON
54191	4.8x19mm(P16)	500	8
54192	4.8x25mm(P16)	500	8
54193	5.5x38mm(P14)	500	8
54194	5.5x50mm(P14)	250	8
54195	6.3x25mm(P14)	500	8
54196	6.3x32mm(P14)	500	8
54197	6.3x50mm(P14)	250	8
54198	6.3x75mm(P14)	250	8

WEDGE ANCHOR

- Galvanized surface
- Designed for fastening items to concrete
- Packing: color box

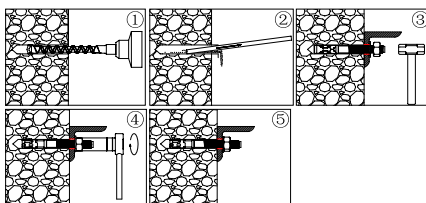

STOCK NO.	SIZE	PCS/BOX	BOXES/CARTON
54251	M6x55mm	50	16
54261	M8x80mm	30	16

HEAVY DUTY 4PCS SHELL ANCHOR

- Galvanized surface
- Packing: color box

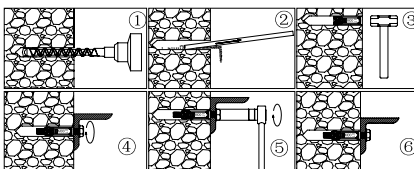

STOCK NO.	SIZE	PCS/BOX	BOXES/CARTON
54276	M6x50mm	40	16
54277	M8x60mm	20	16
54278	M10x70mm	10	16

HEAVY DUTY 4PCS SHELL ANCHOR

- Galvanized surface
- Packing: color box

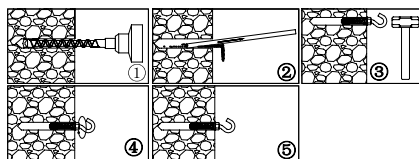

STOCK NO.	SIZE	PCS/BOX	BOXES/CARTON
54281	M6x50mm	30	16
54282	M8x60mm	15	16
54283	M10x70mm	10	16

HEAVY DUTY 4PCS SHELL ANCHOR

- Galvanized surface
- Packing: color box

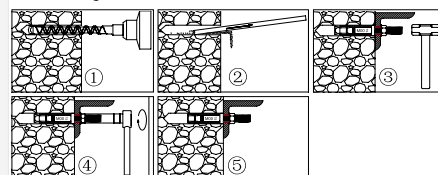

STOCK NO.	SIZE	PCS/BOX	BOXES/CARTON
54286	M6x60mm	40	16
54287	M8x75mm	20	16
54288	M10x100mm	10	16

HAMMER DRIVE ANCHOR

- Zinc Alloy material
- Mushroom head with zinc plated steel nail
- Suitable for fastening into solid concrete, brick or hollow block.
- Ideal for attachment of drywall track, electrical boxes and more
- Packing: color box

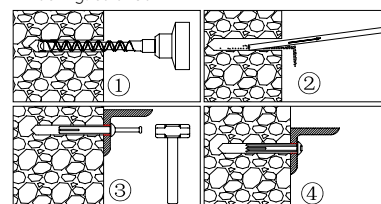

STOCK NO.	SIZE	PCS/BOX	BOXES/CARTON
54291	M6x30mm	60	16
54292	M6x40mm	60	16

NYLON WALL PLUGS

- Nylon
- Heavily ribbed design improves pull-out strength
- High quality nylon wall plugs suitable for medium and lightweight applications in most substrates
- Packing: color box

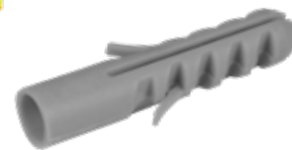

STOCK NO.	SIZE	PCS/BOX	BOXES/CARTON
54301	5x25mm	100	80
54302	6x30mm	100	80
54303	8x40mm	100	50
54304	10x50mm	50	50



OTHERS



BRASS SHUTTER PADLOCK

- Material: brass
- Hardened steel shackle, chrome plated
- With 3pcs brass keys
- Packing: double blister

LOCKplus



STOCK NO.	SIZE	WEIGHT	QTY./ CARTON
55117	60mm	275g	48
55118	70mm	390g	36
55119	80mm	450g	24
55120	90mm	540g	24

HEAVY DUTY BRASS PADLOCK

- Material: brass
- Hardened steel shackle, chrome plated
- Double bolted
- Rustproof interior
- With 3 pcs brass keys
- Packing: double blister

LOCKplus



STOCK NO.	SIZE	WEIGHT	QTY./ CARTON
55111	20mm	38g	192
55113	30mm	100g	120
55114	40mm	166g	72
55115	50mm	282g	48
55116	60mm	395g	36

BRASS PADLOCK

- Material: brass
- Hardened steel shackle, chrome plated
- Double bolted
- Rustproof interior
- With 2 pcs brass keys
- Packing: double blister

LOCKplus



STOCK NO.	SIZE	WEIGHT	QTY./ CARTON
55103	30mm	72g	144
55104	40mm	122g	96
55105	50mm	182g	72
55106	60mm	306g	48

BRASS PADLOCK WITH LONG SHACKLE

- Material: brass
- Hardened steel shackle, chrome plated
- Double bolted
- Rustproof interior
- With 2 pcs brass keys
- Packing: double blister

LOCKplus



STOCK NO.	SIZE	WEIGHT	QTY./ CARTON
55108	30mm	78g	144
55109	40mm	130g	72

COMBINATION BRASS PADLOCK

- Material: brass
- Steel shackle, chrome plated
- Weight: 115g
- With 3 Code Wheels
- Packing: double blister

LOCKplus



STOCK NO.	SIZE	WEIGHT	QTY./ CARTON
55122	20mm	48g	144
55123	30mm	115g	72

IRON PADLOCK

- Material: Iron
- With 3pcs iron keys
- Brass lock cylinder
- With waterproof rubber cover
- Packing: double blister



STOCK NO.	SIZE	WEIGHT	QTY./CARTON
55133	32mm	85g	120
55134	38mm	125g	96
55135	50mm	260g	60
55136	63mm	460g	36

DISC PADLOCK

- Material: stainless steel
- Mirror polished surface
- Hardened steel shackle
- Weight: 190g
- With 2pcs keys, nickel plated
- Packing: double blister



STOCK NO.	SIZE	QTY./CARTON
55175	70mm	72

BICYCLE LOCK

- PVC wirerope, zinc alloy lock cylinder, ABS case
- With 2pcs iron keys
- Packing: tie card



STOCK NO.	SIZE	QTY./CARTON
55170	ø12x800mm	60

MAGNIFYING GLASS

- Magnification :2x, 10x
- Diameter of lens 90mm, 15mm
- Size of magnifier:220x97mm
- Easy grip handle



STOCK NO.	SIZE	QTY./CARTON
50010	2X/10X	48

MAGNIFYING GLASS

- Magnification: 4x
- Diameter of lens 75mm
- Size of magnifier:190x85mm
- Easy grip handle



STOCK NO.	SIZE	QTY./CARTON
50011	4X	48

BOPP PACKING TAPE, CLEAR

- Superb tack and adhesion to surface
- Used for carton sealing
- Transparent
- Five rolls packing: shrink



STOCK NO.	SIZE	QTY./CARTON
50200	48mm x 30m 1.88" x 32.8yards	150
50202	48mm x 50m 1.88" x 54.6yards	100
50206	48mm x 100m 1.88" x 109.3yards	60

BOPP PACKING TAPE, SUPER CLEAR

- Superb tack and adhesion to surface
- Used for carton sealing
- Transparent, super clear
- One roll packing: shrink with color paper



STOCK NO.	SIZE	QTY./CARTON
50203	48mm x 50m 1.88" x 54.6yards	100

BOPP PACKING TAPE, BROWN

- Superb tack and adhesion to surface
- Used for carton sealing
- Brown
- Five rolls packing: shrink



STOCK NO.	SIZE	QTY./CARTON
50212	48mm x 50m 1.88" x 54.6yards	100
50216	48mm x 100m 1.88" x 109.3yards	60

MASKING TAPE

- With excellent heat resistance, fast paste, easy to peel off and tear, writing conveniently, soft and tender
- No residue after peeling off
- Ideal for surface masking protection, powder spraying, baking finish, paint coating masking application
- Packing: shrink with color paper



- EXCELLENT HEAT RESISTANCE**
- WRITING CONVENIENTLY**
- FAST PASTE**
- EASY TO PEEL OFF AND TEAR**

STOCK NO.	SIZE	QTY./CARTON
50244	18mm x 30m 0.71" x 32.8yards	48sets (96pcs)
50245	24mm x 30m 0.94" x 32.8yards	72
50246	36mm x 30m 1.42" x 32.8yards	48
50248	48mm x 30m 1.88" x 32.8yards	36
50249	48mmx50m 1.88" x 54.6 yards	36

SELF ADHESIVE FIBERGLASS TAPE

- High tensile strength, good bonding ability
- Acid-alkaline resistance, corrosion resistance
- Excellent positioning
- Packing: shrink wrap



STOCK NO.	SIZE	QTY./CARTON
50270	48mm x 45m 1.88" x 49.2 yards	36
50271	48mmx90m 1.88" x 98.4 yards	24

CLOTH DUCT TAPE

- Taking textile fabric cloth as the backing which is very durable
- High tensile strength
- Easy to tear by hand
- Designed for the reinforced protection of various pipes and objects, heavy duty packaging, carpet joints and affixing
- Packing: shrink wrap



STOCK NO.	SIZE	QTY./CARTON
50281	48mm x 25m 1.88" x 27.3 yards	36
50282	48mmx50m 1.88" x 54.6yards	24

TAPE DISPENSER

- PP material
- Suitable for adhesive tape
tape width: ≤ 50mm(2"),
tape core diameter: 76mm(3"),
tape outer diameter: 115mm(4.5")
- Including one roll of adhesive tape
- Packing: color box



STOCK NO.	QTY./CARTON
50000	24

NYLON CABLE TIE

- Nylon 66, DuPont raw material
- CE approval
- UL approval
- In accordance with EN62275
- DNV approval
- GL approval
- RoHS approval
- REACH approval
- Nature color
- 100pcs Packing: PE bag with color label



STOCK NO.	SIZE	QTY./CARTON
50105	2.5x100mm	400
50106	2.5x140mm	200
50141	2.5x200mm	200
50107	3.6x140mm	200
50108	3.6x200mm	200
50131	3.6x250mm	50
50143	3.6x300mm	100
50144	3.6x370mm	100
50109	4.8x200mm	100
50146	4.8x250mm	100
50110	4.8x300mm	100
50111	4.8x350mm	50
50112	4.8x400mm	50
50150	7.6x300mm	50
50151	7.6x370mm	30
50153	7.6x450mm	30

NYLON CABLE TIE

- Nylon 66
- Black
- 100pcs Packing: PE bag with color label



STOCK NO.	SIZE	QTY./CARTON
50115	2.5x100mm	400
50116	2.5x140mm	200
50161	2.5x200mm	200
50117	3.6x140mm	200
50118	3.6x200mm	200
50132	3.6x250mm	100
50163	3.6x300mm	100
50164	3.6x370mm	100
50119	4.8x200mm	100
50166	4.8x250mm	200
50120	4.8x300mm	100
50521	4.8x350mm	50
50522	4.8x400mm	50
50170	7.6x300mm	50
50171	7.6x370mm	30
50173	7.6x450mm	30

1200PCS NYLON CABLE TIE SET

- Nylon 66
- Contains:
 - 2.5x100mm White 300pcs
 - 2.5x100mm Black 200pcs
 - 2.5x100mm Yellow 100pcs
 - 2.5x100mm Blue 100pcs
 - 3.5x200mm White 400pcs
 - 4.6x300mm White 100pcs
- Packing: color label



STOCK NO.	QTY./CARTON
50140	12

DENT PULLER

- Plastic body
- Packing: double blister



STOCK NO.	SIZE	CUP DIAMETER	QTY./CARTON
62661	25kgs	11.5cm	24

DENT PULLER

- With two suction cups
- Plastic body
- Packing: double blister



STOCK NO.	SIZE	CUP DIAMETER	QTY./CARTON
62662	50kgs	11.5cm	12

DENT PULLER

- With three suction cups
- Plastic body
- Packing: double blister



STOCK NO.	SIZE	CUP DIAMETER	QTY./CARTON
62663	75kgs	11.5cm	10

2PCS LUGGAGE ROPE SET

- Material: latex and rubber
- Diameter: 7mm
- Hook: 3mm, with protective caps
- Packing: PVC bag with paper hanger



STOCK NO.	SIZE	QTY./CARTON
62242	600mm, 24"	72
62243	900mm, 36"	72

LUGGAGE ROPE

- Material: rubber
- Diameter: 10mm 3/8"
- Hook: 3.2mm 1/8", with protective caps
- Packing: color box



STOCK NO.	SIZE	QTY./CARTON
62237	600mm / 24"	108
62239	1200mm / 48"	72
62240	1800mm / 72"	48

2PCS TIE DOWN SET

- GS approved
- Lashing capacity: 200daN
- Strap width: 25mm
- Packing: blister card

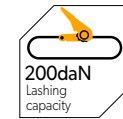

STOCK NO.	SIZE	QTY./CARTON
62246	25mmx2.5M	48

RATCHET TIE DOWN

- GS approved
- Lashing capacity: 135daN
- Strap width: 25mm
- Zinc plated ratchet
- Packing: blister card

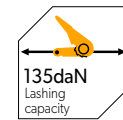

STOCK NO.	SIZE	QTY./CARTON
62248	25mmx5M	36

RATCHET TIE DOWN

- GS approved
- Lashing capacity: 1000daN
- Strap width: 38mm
- With ratchet and double j hooks, Zinc plated
- Packing: plastic hanger with color label

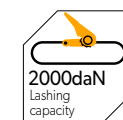
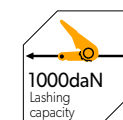

STOCK NO.	SIZE	QTY./CARTON
62261	38mm x 6M	12

INDUSTRIAL

INDUSTRIAL

INDUSTRIAL

RATCHET TIE DOWN

- GS approved
- Lashing capacity: 2500daN
- Strap width: 50mm
- With ratchet and double j hooks, Zinc plated
- Packing: straps

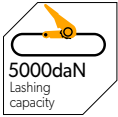
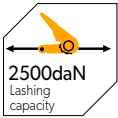

STOCK NO.	SIZE	QTY./CARTON
62265	50mm x 9M	6

2PCS RATCHET TIE DOWN SET

- GS approved
- Lashing capacity: 225daN
- Strap width: 25mm
- Zinc plated ratchet, with PVC grip
- Packing: plastic hanger with color label

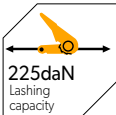

STOCK NO.	SIZE	QTY./CARTON
62252	25mmx5M	12

4PCS RATCHET TIE DOWN SET

- GS approved
- Lashing capacity: 225daN
- Strap width: 25mm
- Zinc plated ratchet, with PVC grip
- Packing: plastic hanger with color label

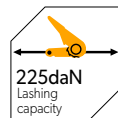

STOCK NO.	SIZE	QTY./CARTON
62254	25mmx5M	6

FOLDABLE HAND TROLLEY

- TUV/GS approved
- Overall size: 425x420x980 mm
- Plate size: 275x420 mm
- High quality tubular steel frame with heavy duty base plate
- With 150mm (6") PP+Rubber Wheels
- Packing: color label with plastic bag



STOCK NO.	MAX. LOAD CAPACITY	QTY./CARTON
62600	70kgs	1

ALUMINUM FOLDABLE HAND TRUCK

- GS approval
- Load capacity: max. 90KGS
- Plate size: 385x245mm
- Closed height: 715mm
- Entended height: 1080mm
- Net. weight: 4.8kgs
- Lightweight aluminium box section frame with telescopic chrome plated tubular steel handle
- Fold-up base for convenient storage
- Packing: color label with plastic bag



STOCK NO.	LOAD CAP. MAX.	QTY./CARTON
62602	90KGS	1

HAND TRUCK

- Maximum load capacity: 200kgs
- Overall size: 1310x550x460mm
- Toe plate size: 350x225mm
- Toe plate thickness: 3.5mm
- Pneumatic wheel: 10"x3.50-4
- Net weight: 9kgs
- High quality tubular steel frame
- Packing: bulk



STOCK NO.	LOAD CAP. MAX.	QTY./CARTON
62610	200KGS	1

FOLDABLE PLATFORM HAND TRUCK

- TUV/GS approved
- With lock bar for folding the 90°
- PP+TPR swivel wheels
- Packing: color label with plastic bag



62606
with brake



STOCK NO.	MAX. LOAD CAPACITY	OVERALL SIZE	PLATFORM SIZE	WHEEL SIZE	QTY./CARTON
62605	150kgs	730 x 470 x 830 mm	730 x 470 mm	100mm, 4"	1
62606	300kgs	900 x 600 x 845mm	900 x 600 mm	125mm, 5"	1

STEEL LADDER

- Material: steel
- Packing : color paper with plastic bag

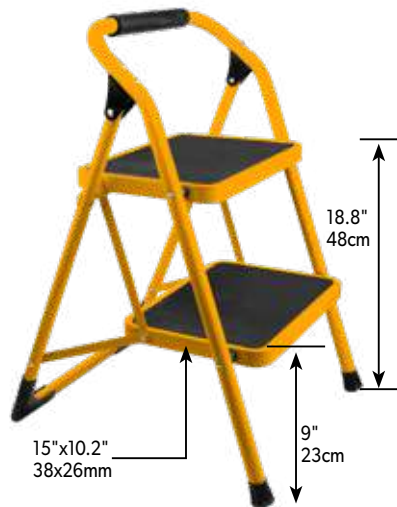

STOCK NO.	LOAD CAPACITY	OPEN SIZE	FOLDING SIZE	QTY./CARTON
62680	200LBS	480 x 510 x 720 mm	480 x 90 x 790 mm	2

STEEL LADDER

- Material: steel
- Packing : color paper with plastic bag

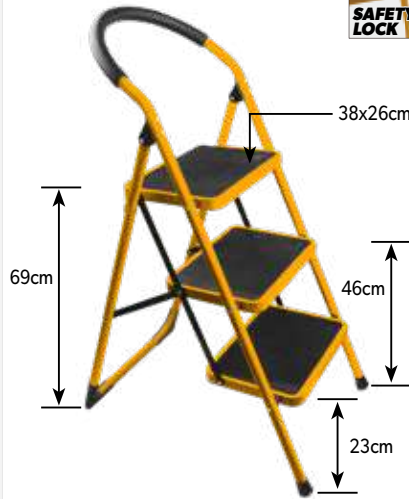

STOCK NO.	LOAD CAPACITY	OPEN SIZE	FOLDING SIZE	QTY./CARTON
62683	150kgs	690 x 470 x 1030 mm	470 x 140 x 1190 mm	2

STEEL LADDER

- Material: steel
- Maxium load :150kg
- Packing : color paper with plastic bag



STOCK NO.	LOAD CAPACITY	OPEN SIZE	QTY./CARTON
62684	150kgs	845x 495 x 1170mm	2

STEEL LADDER

- Material: steel
- Maxium load :150kg
- Packing : color paper with plastic bag



STOCK NO.	LOAD CAPACITY	OPEN SIZE	QTY./CARTON
62685	150kg	1085x 495 x 1390mm	2

SHELF BRACKET

- Special tool steel
- Powder coated
- Packing: paper hanger



STOCK NO.	SIZE	QTY./CARTON
51011	100x75mm	288
51012	100x125mm	288
51013	125x150mm	288
51014	150x200mm	288
51015	200x250mm	144
51016	250x300mm	144
51017	300x350mm	144

INDUSTRIAL

CEILING BRUSH

- PET
- Plastic (PP) handle
- Packing: color label with shrink



STOCK NO.	SIZE	QTY./CARTON
50004	170x70mm	48

DRAIN CLEANER

- Full flexible plated spring steel
- With plastic handle
- With "S" hook, zinc plated
- Packing: color label with shrink



STOCK NO.	SIZE	QTY./CARTON
50100	Ø6mmx3M	40
50101	Ø9mmx5M	10
50102	Ø9mmx10M	5

ALUMINIUM PICK UP TOOL

- Aluminium alloy tube
- Tube dia.:23.8mm, thickness:0.8mm
- Ergonomic handle with safety lock
- Non-slip rubber jaw to ensure a secure hold
- High quality nylon plastic components
- Packing: hang tag



STOCK NO.	LENGTH	QTY./CARTON
50093	870mm	12

4PCS ANTI-FATIGUE JOINT MAT SET

- Black Color
- High quality EVA foam
- Anti-slip
- Interlock connectable sides
- Packing: 4pcs in shrink with color paper

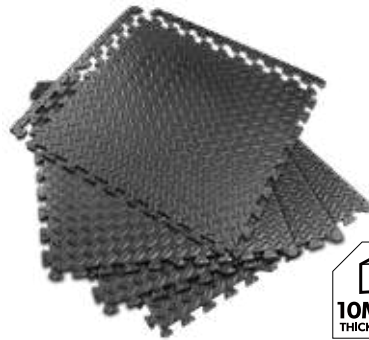

STOCK NO.	SIZE	THICKNESS	QTY./CARTON
65497	24" x 24" (600x600mm)	10mm	10 sets

ANTI-FATIGUE FOAM MAT

- Black Color
- High quality EVA foam
- RoHS approved
- Water resistant
- Easy to clean mats are great for use around sinks and washers to prevent injuries and to protect floors
- Great for use in work shops and garages to prevent fatigue
- Packing: shrink with color paper

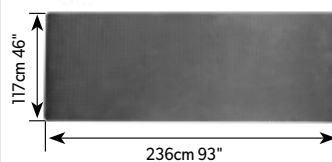

STOCK NO.	SIZE	QTY./CARTON
65499	46"x93" (117x236cm)	6

WHEEL BARROW

- Load capacity:150 kgs
- Water Capacity:85 L
- Wheel:16"x4"-8 (pneumatic wheel)
- Tray with 1mm thickness
- Handle size:1.2x32mm
- Packing: bulk

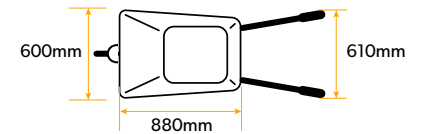
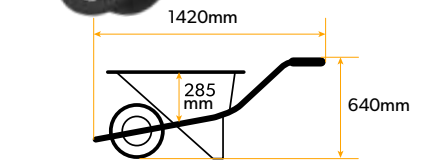

STOCK NO.	SIZE	QTY./CARTON
62626		50

PNEUMATIC WHEEL

- 4PR Tyre with diamond lines
- Ball bearing
- Packing: color label



STOCK NO.	SIZE	QTY./CARTON
62635	16"x4.00-8	5

PU FOAM WHEEL

- Ball bearing
- Packing: color label



STOCK NO.	SIZE	QTY./CARTON
62636	16"x4.00-8	5

INDUSTRIAL



TOOL BAG & STORAGE

PLASTIC TOOL BOX

- Separately PP box
- Net weight: 670g



STOCK NO.	SIZE	QTY./CARTON
80190	340x180x130mm	12

HEAVY DUTY PLASTIC TOOL BOX

- Separately PP box
- Net weight: 1.5kgs



STOCK NO.	SIZE	QTY./CARTON
80201	420x230x190mm	9

6 DRAWER ROLLER CABINET

- Overall size with caster: 840x465x885mm
- Fitted with two fixed and two braked swivelling casters 5"x1.88"
- PP material work table with steel handle
- Thickness of cabinet: 0.8mm
- Thickness of drawer: 0.7mm
- Drawers are fitted with EVA foam liner and ball bearing runners for smooth operation & long time;
- Secure intergral locking system supplied with two keys;
- Configuration:
4pcs drawers: 549x400x70mm
2pcs drawers: 549x400x140mm
- Side storage cabinet features one fixed bucket.
- Packed by master carton



STOCK NO.	SIZE	QTY./CARTON
80306	840x465x885mm	1

TOOL BOX

- Steel thickness: 0.6-0.8mm
- Net weight: 3.3kgs/7.3lbs
- 3 layers



STOCK NO.	SIZE	QTY./CARTON
80211	404x200x205mm	1

TOOL BOX

- Steel thickness: 0.6-0.8mm
- Net weight: 5.1kgs/11.2lbs
- 3 layers



STOCK NO.	SIZE	QTY./CARTON
80212	495x200x295mm	1

THREE TRAY TOOL CART

- Overall with caster :840x410x780mm
- Trays: 740x390x90mm
- Packing: drawing box



STOCK NO.	OVERALL SIZE	QTY./CARTON
80221	840x410x660mm	1

TOOL BAG

- Rigid frame for easy opening and access
- Special partition of the internal and external pockets, easy access to the tool compartment
- Adjustable shoulder strap included
- Light weight fabric box
- Packing: polybag with paper card



PRODUCTS NOT INCLUDED

STOCK NO.	SIZE	QTY./CARTON
80101	17"	10

TOOL BAG

- Special partition of the internal and external pockets, easy access to the tool compartment
- Stainless handle
- Adjustable shoulder strap included
- Special double bottom design
- Closing flap
- Light weight fabric box
- Packing: polybag with paper card



PRODUCTS NOT INCLUDED

STOCK NO.	SIZE	QTY./CARTON
80102	17"	4

TOOL BAG

- Rigid frame for easy opening and access
- Reinforced plastic base for durability
- Special partition of the internal and external pockets, easy access to the tool compartment
- Adjustable shoulder strap included
- Packing: polybag with paper card



PRODUCTS NOT INCLUDED

STOCK NO.	SIZE	QTY./CARTON
80103	16"	6

TOOL BAG

- Foldable construction
- With 8 interior holders
- With 15 pockets
- Stainless steel tube, foam rubber handle
- Adjustable shoulder strap
- Packing: paper hanger with polybag



PRODUCTS NOT INCLUDED

STOCK NO.	SIZE	QTY./CARTON
80112	17" (42x21x29cm)	10

TOOL POUCH

- With 11 pockets
- 1pc hammer loop
- 1pc measuring tape clasp
- Adjustable strap
- Packing: paper hanger with polybag



STOCK NO.	QTY./CARTON
80120	20

TOOL VEST

- Tool compartments for easy storage and convenient access to tools
- All woven bags are stitched with X reinforcement knots
- Storage compartments for personal belongings such as mobile phone
- Mesh material allows air movement for comfort throughout the day
- Adjustable shoulder straps for secure fit - one size fits all



STOCK NO.	SIZE	QTY./CARTON
80130	510x600mm	24

BACKPACK

- Material: nylon
- Capacity: 38.4L
- Weight: 1.12Kg
- Usage: daily
- Style: professional
- Feature: light weight waterproof
- Function: hiking, outdoor trekking, sport traveling
- Packing: polybag with paper card



STOCK NO.	SIZE	QTY./CARTON
90009	32cm x 25cm x 48cm	4

BACKPACK

- 16 multi-function combination pockets with 1 pc key ring.
- 3 suspension cushioning designed pockets for electronic devices, the maximum can accommodate a 15.4-inch laptop
- 1pc built-in fixed elastic buckle
- Multi-sided airflow design provides honeycomb back pads, shoulder straps, breathable, adjustable shoulder straps, belt liners, help to relieve the back pressure of shoulders, and protect your items Free use of any bumps on the road, lasting. This computer backpack has tie rod fixtures, which can be fixed in trolley boxes, Large Carry On Travel Backpack makes your travel easier.
- Made of lightweight waterproof polyester and scratch materials
- Net weight: 645g/1.41LB
- Packing: polybag with paper card

NEW



STOCK NO.	SIZE	QTY./CARTON
80040	32cm x 25cm x 48cm	6

DISPLAY STAND

- With light box
- Not include products and hooks



STOCK NO.	SIZE	QTY./CARTON
83037	1000x2300mm	1

DISPLAY STAND

- Without light box
- Not include products and hooks



STOCK NO.	SIZE	QTY./CARTON
83039	1000x530x2320mm	1

DUAL LONG HOOK

- Chrome plated
- 50pcs packed in one drawing box

x50



STOCK NO.	SIZE	QTY./CARTON
83021	200mm	5BOXES

SINGLE LONG HOOK

- Chrome plated
- 50pcs packed in one drawing box

x50



STOCK NO.	SIZE	QTY./CARTON
83024	200mm	8BOXES

TOLSEN



NON SPARKING TOOLS



The TOLSEN non-sparking tools are specially designed for safe operations in environments subject to potential risk of explosion, in the presence of flammable liquids or gases, or for any applications that require using perfectly antimagnetic, corrosion-resistant tools.



The TOLSEN non-sparking tools can be used in a wide variety of fields, such as:

- Mining
- Petrol and gas extraction (off-shore and on-shore)
- Refineries, petrochemicals
- Pipeline maintenance
- Energy production and transport (gas, electricity, etc.)
- Naval shipyards
- Aeronautical transport, airports
- Paint manufacture
- Manufacture of explosives & flammable products
- Arsenals, munitions and explosive products storage
- Applications requiring demagnetised tools (metal shavings, - etc.)
- Farming - Grain silos
- ...

CLASSIFICATION OF AREAS SUBJECT TO EXPLOSION RISK

ATEX	HIGH	MEDIUM-LOW	EXTREMELY LOW
GASES	<p>ZONE 0</p> <p>AN area in which an explosive atmosphere consisting of a mixture of air and flammable substances in the form of gas, vapour or mist is continuously present or present for long periods or frequently</p>	<p>ZONE 1</p> <p>AN area in which an explosive atmosphere consisting of a mixture of air and flammable substances in the form of gas, vapour or mist is likely to occur in normal operation</p>	<p>ZONE 2</p> <p>AN area in which an explosive atmosphere consisting of a mixture of air and flammable substances in the form of gas, vapour or mist is not likely to occur in normal operation but if it does occur, will persist for a short period only</p>
DUSTS	<p>ZONE 20</p> <p>AN area in which an explosive atmosphere in the form of a cloud of combustible dust in air is continuously present or present for long periods or frequently</p>	<p>ZONE 21</p> <p>AN area in which an explosive atmosphere in the form of a cloud of combustible dust in air is likely to occur in normal operation occasionally.</p>	<p>ZONE 22</p> <p>AN area in which an explosive atmosphere in the form of a cloud of combustible dust in air is not likely to occur in normal operation but, if it does occur, will persist for a short period only.</p>

NON SPARKING 1/2" DRIVE SOCKETS (SIX POINT)

- In accordance to DIN 3124 / ISO 2725-1
- Internal square in accordance to DIN 3120 / ISO 1174 with ball reception
- Non-sparking
- Explosion proof
- Corrosion resistant
- Wear resistant
- Aluminium-Bronze (Non-Ferrous Alloy)
- Packing: color box



STOCK NO.	SIZE	LENGTH	Al-Cu
70108	8mm	40mm	64g
70110	10mm	40mm	67g
70111	11mm	40mm	66g
70112	12mm	40mm	64g
70113	13mm	40mm	75g
70114	14mm	40mm	80g
70115	15mm	40mm	86g
70116	16mm	40mm	82g
70117	17mm	40mm	72g
70118	18mm	40mm	117g
70119	19mm	40mm	105g
70120	20mm	40mm	125g
70121	21mm	40mm	126g
70122	22mm	40mm	135g
70123	23mm	40mm	146g
70124	24mm	40mm	142g
70125	25mm	40mm	157g
70126	26mm	40mm	174g
70127	27mm	40mm	174g
70128	28mm	40mm	210g
70129	29mm	40mm	212g
70130	30mm	40mm	231g
70131	31mm	42mm	243g
70132	32mm	42mm	272g

NON SPARKING 1/2" REVERSIBLE RATCHET WRENCH

- In accordance to DIN 3122 / ISO 3315
- Square drive in accordance to DIN 3120 / ISO 1174 with ball lock
- Reversible
- Gearing with 45 teeth
- Non-sparking
- Explosion proof
- Corrosion resistant
- Very breakage resistant
- Aluminium-Bronze (Non-Ferrous-Alloy)
- Packing: color box



STOCK NO.	SIZE	LENGTH	Al-Cu
70140	1/2"	250mm	615g

INDUSTRIAL

NON SPARKING 1/2" SLIDING BAR

- In accordance to DIN 3122 / ISO 3315
- Square drive in accordance to DIN 3120 / ISO 1174 with ball lock
- Non-sparking
- Explosion proof
- Corrosion resistant
- Very breakage resistant
- Aluminium-Bronze (Non-Ferrous-Alloy)
- Packing: color box



STOCK NO.	SIZE	LENGTH	Al-Cu
70145	1/2"	250mm	310g

NON SPARKING UNIVERSAL JOINT

- In accordance to DIN 3123 / ISO 3316
- Square drive in accordance to DIN 3120 / ISO 1174 with ball reception
- Internal square in accordance to DIN 3120 / ISO 1174 with ball reception
- Non-sparking
- Explosion proof
- Corrosion resistant
- Very breakage resistant
- Aluminium-Bronze (Non-Ferrous-Alloy)
- Packing: color box



STOCK NO.	SIZE	LENGTH	Al-Cu
70151	1/2"	75mm	170g
70152	3/4"	100mm	480g
70153	1"	135mm	900g

NON SPARKING DRIVER EXTENSION

- In accordance to DIN 3123 / ISO 3316
- Square drive in accordance to DIN 3120 / ISO 1174 with ball reception
- Internal square in accordance to DIN 3120 / ISO 1174 with ball reception
- Non-sparking
- Explosion proof
- Corrosion resistant
- Very breakage resistant
- Aluminium-Bronze (Non-Ferrous-Alloy)
- Packing: color box



STOCK NO.	SIZE	LENGTH	Al-Cu
70161	1/2"	125mm	230g
70162	1/2"	250mm	330g

INDUSTRIAL

NON SPARKING 17PCS 1/2" DR SOCKET SET

- Sockets: 10, 11, 12, 14, 17, 19, 22, 24, 27, 30 32mm
- Ratchet Wrench 1/2" x 250mm.
- Sliding T-Handle 1/2" x 250mm
- Speed handle 1/2" x 400mm
- Driver Extension 1/2" x 125mm & 1/2" x 250mm
- Non-sparking
- Explosion proof
- Corrosion resistant
- Very breakage resistant
- Aluminium-Bronze (Non-Ferrous-Alloy)



STOCK NO.	SIZE
70024	1/2"

NON SPARKING COMBINATION SPANNER

- In accordance to DIN 3113 Form A / ISO 3318 / ISO 7738
- Non-sparking
- Explosion proof
- Corrosion resistant
- Wear resistant
- Aluminium-Bronze (Non-Ferrous-Alloy)
- Packing: color box



STOCK NO.	SIZE	LENGTH	Al-Cu
70200	6mm	120mm	29g
70201	7mm	120mm	31g
70202	8mm	120mm	25g
70203	9mm	135mm	38g
70204	10mm	135mm	40g
70205	11mm	150mm	61g
70206	12mm	150mm	63g
70207	13mm	175mm	98g
70208	14mm	175mm	88g
70209	15mm	190mm	118g
70210	16mm	190mm	113g
70211	17mm	190mm	110g
70212	18mm	215mm	158g
70213	19mm	215mm	164g
70214	20mm	245mm	242g
70215	21mm	245mm	240g
70216	22mm	245mm	229g
70217	23mm	265mm	298g
70218	24mm	265mm	276g
70219	25mm	265mm	279g
70220	26mm	290mm	427g
70221	27mm	290mm	423g
70222	28mm	290mm	417g
70223	29mm	320mm	541g
70224	30mm	320mm	513g
70225	31mm	340mm	701g
70226	32mm	340mm	684g

INDUSTRIAL

INDUSTRIAL

INDUSTRIAL

NON SPARKING DOUBLE OPEN ENDED SPANNER

- In accordance to DIN 895 / ISO 3318 / ISO 1085
- Non-sparking
- Explosion proof
- Corrosion resistant
- Wear resistant
- Aluminium-Bronze (Non-Ferrous-Alloy)
- Packed by color box



STOCK NO.	SIZE	LENGTH	Al-Cu
70230	6x7mm	92mm	22g
70231	8x9mm	98mm	33g
70232	10x11mm	115mm	47g
70233	12x13mm	128mm	67g
70234	14x15mm	150mm	95g
70235	16x17mm	165mm	110g
70236	18x19mm	165mm	112g
70237	20x22mm	185mm	146g
70238	21x23mm	210mm	223g
70239	24x27mm	230mm	294g
70240	25x28mm	230mm	302g
70241	30x32mm	260mm	482g

NON SPARKING DOUBLE RING SPANNER OFFSET

- In accordance to DIN 895 / ISO 3318 / ISO 1085
- Non-sparking
- Explosion proof
- Corrosion resistant
- Wear resistant
- Aluminium-Bronze (Non-Ferrous-Alloy)
- Packed by color box



STOCK NO.	SIZE	LENGTH	Al-Cu
70250	6x7mm	120mm	32g
70251	8x9mm	130mm	46g
70252	10x11mm	160mm	75g
70253	12x13mm	180mm	99g
70254	14x15mm	220mm	142g
70255	16x17mm	250mm	211g
70256	18x19mm	250mm	208g
70257	20x22mm	280mm	283g
70258	21x23mm	310mm	348g
70259	24x27mm	340mm	487g
70260	25x28mm	340mm	468g
70261	30x32mm	380mm	677g

NON SPARKING ADJUSTABLE WRENCH

- Non-sparking
- Explosion proof
- Corrosion resistant
- Very breakage resistant
- Aluminium-Bronze (Non-Ferrous-Alloy)
- Packing: color box



STOCK NO.	SIZE	Al-Cu
70302	150mm, 6"	134g
70303	220mm, 8"	231g
70304	250mm, 10"	358g
70305	300mm, 12"	671g
70306	375mm, 15"	1262g
70307	450mm, 18"	1768g
70308	60mm, 24"	3950g

NON SPARKING PIPE WRENCH

- Non-sparking
- Explosion proof
- Corrosion resistant
- Wear resistant
- Aluminium-Bronze (Non-Ferrous-Alloy)
- Packing: color box



STOCK NO.	SIZE	Al-Cu
70311	200mm, 8"	404g
70312	250mm, 10"	714g
70313	300mm, 12"	955g
70314	350mm, 14"	1365g
70315	450mm, 18"	2050g
70316	600mm, 24"	3300g
70317	900mm, 36"	5750g

NON SPARKING OPEN ENDED SLOGGING WRENCH

- In accordance to DIN 133
- With impact area
- For heavy duty applications
- Non-sparking
- Explosion proof
- Corrosion resistant
- Wear resistant
- Aluminium-Bronze (Non-Ferrous-Alloy)
- Packing: color box



STOCK NO.	SIZE	LENGTH	Al-Cu
70324	24mm	150mm	220g
70325	26mm	160mm	260g
70326	27mm	160mm	268g
70327	30mm	175mm	372g
70328	32mm	190mm	421g
70330	35mm	210mm	685g
70331	36mm	210mm	688g
70333	41mm	220mm	739g
70334	46mm	245mm	1060g
70335	50mm	260mm	1229g
70336	55mm	280mm	1705g
70339	60mm	300mm	2213g
70341	65mm	310mm	2239g
70343	70mm	325mm	2558g
70344	75mm	345mm	3400g
70345	80mm	365mm	2600g

NON SPARKING 12 POINT RING SLOGGING WRENCH

- Flank Traction profile (12 point)
- In accordance to DIN 7444
- With impact area
- For heavy duty applications
- Non-sparking
- Explosion proof
- Corrosion resistant
- Wear resistant
- Aluminium-Bronze (Non-Ferrous-Alloy)
- Packing: color box



STOCK NO.	SIZE	LENGTH	Al-Cu
70394	24mm	155mm	216g
70395	26mm	165mm	291g
70396	27mm	165mm	298g
70397	30mm	175mm	410g
70398	32mm	175mm	388g
70400	35mm	195mm	579g
70401	36mm	195mm	562g
70403	41mm	220mm	723g
70404	46mm	230mm	879g
70405	50mm	245mm	1138g
70406	55mm	255mm	1170g
70409	60mm	265mm	1277g
70411	65mm	290mm	1890g
70413	70mm	320mm	2342g
70414	75mm	330mm	2682g
70415	80mm	345mm	2960g

NON SPARKING RATCHET WRENCH FOR SOCKET

- With centring point
- Non-sparking
- Explosion proof
- Corrosion resistant
- Wear resistant
- Aluminium-Bronze (Non-Ferrous-Alloy)
- Packing: color box



STOCK NO.	SIZE	LENGTH	Al-Cu
70421	17mm	225mm	479g
70422	19mm	245mm	566g
70423	21mm	260mm	642g
70424	22mm	260mm	642g
70425	24mm	265mm	666g
70426	26mm	280mm	848g
70427	27mm	280mm	795g
70428	30mm	300mm	906g
70429	32mm	310mm	1018g
70430	35mm	330mm	1308g
70431	36mm	330mm	1308g
70432	41mm	335mm	1621g

NON SPARKING 45° BENT NOSE PIPE WRENCH

- In accordance to DIN 5234
- 45° angled
- Non-sparking
- Explosion proof
- Corrosion resistant
- Very breakage resistant
- Aluminium-Bronze (Non-Ferrous-Alloy)
- Packing: color box



STOCK NO.	SIZE	LENGTH	Al-Cu
70481	1-1/2"	450mm	1549g
70482	2"	530mm	1669g

INDUSTRIAL

NON SPARKING MACHINIST HAMMER

- In accordance to DIN 1041
- With fiberglass handle
- Head and edge areas ground
- Edges rounded off
- Non-sparking
- Explosion proof
- Corrosion resistant
- Wear resistant
- Aluminium-Bronze (Non Ferrous Alloy)
- Packing: color box



STOCK NO.	SIZE
70601	300g
70602	500g
70603	1000g
70604	1500g

INDUSTRIAL

NON SPARKING CLAW HAMMER

- With fiberglass handle
- Head and edge areas ground
- Edges rounded off
- Non-sparking
- Explosion proof
- Corrosion resistant
- Wear resistant
- Aluminium-Bronze (Non Ferrous Alloy)
- Packing: color box



STOCK NO.	SIZE
70620	8OZ
70621	16OZ

INDUSTRIAL

NON SPARKING VALVE WHEEL WRENCH

- Non-sparking
- Explosion proof
- Corrosion resistant
- Wear resistant
- Aluminium-Bronze (Non-Ferrous-Alloy)
- Packing: color box

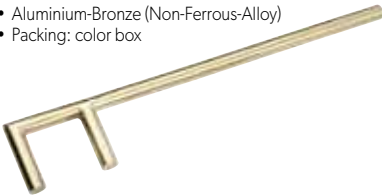

STOCK NO.	SIZE
70511	30x300mm
70512	40x400mm
70513	50x500mm
70514	60x600mm

INDUSTRIAL

NON SPARKING STONING HAMMER

- In accordance to DIN 6475
- With fiberglass handle
- Head and edge areas ground
- Edges rounded off
- Non-sparking
- Explosion proof
- Corrosion resistant
- Wear resistant
- Aluminium-Bronze (Non Ferrous Alloy)
- Packing: color box



STOCK NO.	SIZE
70606	1000g
70607	1500g
70608	2000g

INDUSTRIAL

NON SPARKING BALL PEIN HAMMER

- With fiberglass handle
- Head and edge areas ground
- Edges rounded off
- Non-sparking
- Explosion proof
- Corrosion resistant
- Wear resistant
- Aluminium-Bronze (Non Ferrous Alloy)
- Packing: color box



STOCK NO.	SIZE
70626	16OZ
70628	32OZ

INDUSTRIAL

NON SPARKING UNIVERSAL BARREL WRENCH

- For current barrel clasps
- Non-sparking
- Explosion proof
- Corrosion resistant
- Wear resistant
- Aluminium-Bronze (Non-Ferrous-Alloy)
- Packing: color box



STOCK NO.	SIZE	Al-Cu
70520	300mm	780g

INDUSTRIAL

NON SPARKING SLEDGE HAMMER

- With fiberglass handle
- Head and edge areas ground
- Edges rounded off
- Non-sparking
- Explosion proof
- Corrosion resistant
- Wear resistant
- Aluminium-Bronze (Non Ferrous Alloy)
- Packing: color box



STOCK NO.	SIZE
70611	2LBS
70612	3LBS
70613	4LBS
70614	6LBS
70615	8LBS

INDUSTRIAL

NON SPARKING COMBINATION PLIERS

- Non-sparking
- Explosion proof
- Corrosion resistant
- Very breakage resistant
- Copper Beryllium (Non-Ferrous-Alloy)
- With two component handle
- Packing: color box



STOCK NO.	SIZE	Al-Cu
70801	160mm, 6"	227g
70802	200mm, 8"	369g

INDUSTRIAL

NON SPARKING UNIVERSAL BARREL WRENCH

- For current barrel clasps
- Non-sparking
- Explosion proof
- Corrosion resistant
- Wear resistant
- Aluminium-Bronze (Non-Ferrous-Alloy)
- Packing: color box



STOCK NO.	SIZE	Al-Cu
70522	350mm	1182g

INDUSTRIAL

NON SPARKING DIAGONAL CUTTING PLIERS

- Non-sparking
- Explosion proof
- Corrosion resistant
- Very breakage resistant
- Copper Beryllium (Non-Ferrous-Alloy)
- With two component handle
- Packing: color box



STOCK NO.	SIZE	Al-Cu
70806	160mm, 6"	181g
70807	200mm, 8"	269g

NON SPARKING SWEDISH 45° PIPE WRENCH

- In accordance to DIN ISO 8976
- With dipped covered handle
- Non-sparking
- Explosion proof
- Corrosion resistant
- Very breakage resistant
- Aluminium-Bronze (Non-Ferrous-Alloy)
- Packing: color box



STOCK NO.	SIZE	Al-Cu
70810	10"	370g

NON SPARKING SCREWDRIVER

- Slotted
- In accordance to DIN ISO 2380-2 / 2380-1 Form A
- With hanging hole
- With two component handle
- Non-sparking
- Explosion proof
- Corrosion resistant
- Very breakage resistant
- Aluminium-Bronze (Non-Ferrous-Alloy)
- Packing: color box



STOCK NO.	SIZE	Al-Cu
71001	3.0x50mm	32g
71002	3.0x75mm	40g
71003	4.0x100mm	50g
71004	5.0x125mm	85g
71005	6.0x125mm	110g
71006	8.0x200mm	155g
71007	9.0x250mm	170g
71008	10.0x300mm	245g

NON SPARKING SCREWDRIVER

- Phillips
- In accordance to DIN ISO 2380-2 / 2380-1 Form A
- With hanging hole
- With two component handle
- Non-sparking
- Explosion proof
- Corrosion resistant
- Very breakage resistant
- Aluminium-Bronze (Non-Ferrous-Alloy)
- Packing: color box



STOCK NO.	SIZE	Al-Cu
71011	3.0x50mm	32g
71012	3.0x75mm	40g
71013	4.0x100mm	50g
71014	5.0x125mm	85g
71015	6.0x125mm	110g
71016	8.0x200mm	155g
71017	9.0x250mm	170g
71018	10.0x300mm	245g

NON SPARKING KNIFE

- Non-sparking
- Explosion proof
- Corrosion resistant
- Wear resistant
- Aluminium-Bronze blade (Non-Ferrous-Alloy)
- Fine wooden handle
- Packing: color box



STOCK NO.	SIZE	Al-Cu
71201	150mm	125g

NON SPARKING PUTTY HAND SCRAPER

- Non-sparking
- Explosion proof
- Corrosion resistant
- Wear resistant
- Aluminium-Bronze blade (Non-Ferrous-Alloy)
- Fine wooden handle
- Packing: color box



STOCK NO.	SIZE	LENGTH	Al-Cu
71211	1"	200mm	80g
71212	1-1/2"	200mm	95g
71213	2"	200mm	115g
71214	3"	200mm	120g
71215	4"	200mm	165g

NON SPARKING DECK SCRAPER

- Non-sparking
- Explosion proof
- Corrosion resistant
- Wear resistant
- Aluminium-Bronze (Non-Ferrous-Alloy)
- Packing: color sticker



STOCK NO.	SIZE	Al-Cu
71261	50x900mm	625g

NON SPARKING SQUARE SHOVEL

- With beech handle
- Non-sparking
- Explosion proof
- Corrosion resistant
- Wear resistant
- Aluminium-Bronze (Non-Ferrous-Alloy)
- Packing: color sticker



STOCK NO.	SIZE	LENGTH	Al-Cu
71271	240x420mm	1000mm	1754g

NON SPARKING ROUND POINT SHOVEL

- With beech handle
- Non-sparking
- Explosion proof
- Corrosion resistant
- Wear resistant
- Aluminium-Bronze (Non-Ferrous-Alloy)
- Packing: color sticker



STOCK NO.	SIZE	LENGTH	Al-Cu
71281	235x420mm	1000mm	1549g

NON SPARKING CHAIN BLOCK

- Non-sparking
- Explosion proof
- Corrosion resistant
- Wear resistant
- Aluminium-Bronze (Non-Ferrous-Alloy)
- Packing: wooden case



STOCK NO.	SIZE
71805	0.5Ton
71810	1Ton
71820	2Ton
71830	3Ton
71835	5Ton



MERCHANDISING & PROMOTIONAL

CAPS

• 100% cotton



STOCK NO.	SIZE	QTY./CARTON
90001		50

CUPS



STOCK NO.	SIZE	QTY./CARTON
90002	85x95mm	36

NONWOVEN BAG



STOCK NO.	SIZE	QTY./CARTON
90005	400x350x120mm	100

NOTE BOOKS

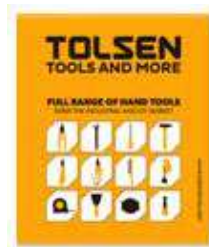

STOCK NO.	SIZE	QTY./CARTON
90006	105x125mm	40

ASHTRAY



STOCK NO.	QTY./CARTON
90008	36

T-SHIRT



STOCK NO.	SIZE	QTY./CARTON
90010	Asia size M-L-XL-XXL	6 (Mx1, Lx2, XLx2, XXLx1)
90011	Euro size M-L-XL-XXL	6 (Mx1, Lx2, XLx2, XXLx1)

CATALOGUE



STOCK NO.	QTY./CARTON
90018	20

MARKETING BROCHURE



STOCK NO.	QTY./CARTON
90019	100

PEN

• 48pcs packed in one drawing box



STOCK NO.	QTY./CARTON
90015	10boxes

TENT

• 1pc packed in one color box



STOCK NO.	SIZE	QTY./CARTON
90024	2mx2m	1
90025	3mx3m	1

DISPLAY STAND

> PAGE 195



INDEX

STOCK NO.	PAGE	STOCK NO.	PAGE	STOCK NO.	PAGE	STOCK NO.	PAGE	STOCK NO.	PAGE	STOCK NO.	PAGE	STOCK NO.	PAGE	STOCK NO.	PAGE		
10000	32	10055	36	10153	38	10246	36	10330	33	15114	44	15211	42	15295	42	15474	40
10001	32	10056	36	10155	38	10247	36	10345	35	15115	44	15212	42	15296	42	15475	40
10002	32	10057	36	10156	38	10251	37	10360	38	15116	44	15213	42	15297	42	15476	40
10003	32	10058	36	10161	38	10252	37	10361	38	15117	44	15214	42	15303	39	15477	40
10004	32	10059	36	10163	38	10253	37	10362	38	15118	44	15215	42	15308	39	15478	40
10006	32	10060	36	10189	38	10254	37	10380	35	15119	44	15216	42	15309	39	15479	40
10007	32	10061	36	10191	38	10256	37	10381	36	15120	44	15217	42	15310	39	15486	41
10008	32	10062	36	10193	38	10257	37	10400	32	15121	44	15218	42	15311	39	15487	41
10013	32	10063	36	10194	38	10258	37	10403	31	15122	44	15219	42	15324	40	15501	45
10014	32	10064	36	10198	38	10259	37	10410	33	15123	44	15220	42	15326	40	15502	45
10015	32	10066	36	10199	38	10270	34	10500	132	15124	44	15221	42	15329	40	15503	45
10016	32	10067	36	10200	38	10272	34	10501	137	15127	44	15223	42	15330	40	15504	45
10017	32	10068	36	10201	38	10274	34	10502	137	15128	44	15226	42	15332	40	15510	48
10018	33	10069	36	10204	38	10276	34	10804	38	15129	44	15228	42	15333	40	15552	45
10019	33	10070	36	10206	38	10278	34	10806	38	15130	44	15229	43	15380	40	15553	45
10021	33	10071	36	10207	38	10280	34	10808	38	15131	44	15234	43	15390	45	15554	45
10022	33	10072	36	10209	38	10282	34	15001	39	15132	45	15235	43	15391	45	15555	45
10023	33	10073	36	10210	38	10284	34	15002	39	15133	45	15236	43	15392	45	15557	45
10028	33	10077	37	10218	38	10290	35	15003	39	15134	45	15237	43	15395	29	15814	39
10029	33	10078	37	10221	36	10291	35	15004	39	15138	29	15238	43	15401	42	15815	39
10030	34	10082	37	10222	36	10292	35	15005	39	15139	28	15239	43	15404	42	15816	39
10031	34	10083	37	10223	36	10294	95	15006	39	15141	46	15240	43	15405	42	15817	39
10033	34	10087	37	10224	36	10299	34	15007	39	15142	28	15241	43	15410	42	15818	39
10038	34	10088	37	10225	36	10300	34	15079	43	15145	25	15242	43	15412	42	15819	39
10039	34	10092	37	10226	36	10301	37	15085	44	15146	26	15243	43	15461	40	15820	39
10040	34	10093	37	10231	37	10304	34	15086	44	15147	27	15244	43	15462	40	15821	39
10041	34	10097	37	10232	37	10305	33	15087	43	15148	46	15245	43	15463	40	15822	39
10042	34	10100	37	10233	37	10311	35	15089	43	15150	45	15246	43	15464	40	15823	39
10043	35	10101	38	10234	37	10313	35	15091	43	15151	45	15247	43	15465	40	15824	39
10044	35	10107	37	10235	37	10314	35	15092	43	15152	45	15248	43	15466	40	15825	39
10045	35	10112	38	10236	37	10315	35	15093	43	15204	42	15249	43	15467	40	15826	39
10048	35	10113	38	10237	37	10316	35	15096	43	15205	42	15250	43	15468	40	15827	39
10049	35	10114	38	10241	36	10321	35	15098	43	15206	42	15259	43	15469	40	15828	39
10050	36	10115	38	10242	36	10322	35	15110	44	15207	42	15280	39	15470	40	15829	39
10051	35	10123	38	10243	36	10323	34	15111	44	15208	42	15282	43	15471	40	15830	39
10052	35	10125	38	10244	36	10326	34	15112	44	15209	42	15292	42	15472	40	15831	39
10053	36	10151	38	10245	36	10329	33	15113	44	15210	42	15293	42	15473	40	15832	39

INDEX

STOCK NO.	PAGE	STOCK NO.	PAGE	STOCK NO.	PAGE	STOCK NO.	PAGE	STOCK NO.	PAGE	STOCK NO.	PAGE	STOCK NO.	PAGE	STOCK NO.	PAGE		
15833	39	15888	41	16508	47	16562	47	18215	47	18289	48	20033	53	20132	49	20207	55
15834	39	15889	41	16509	47	16563	47	18216	47	18295	48	20034	54	20133	49	20212	55
15835	39	15891	41	16510	47	16564	47	18217	47	18296	48	20035	54	20134	49	20213	55
15836	39	15892	42	16511	47	16565	47	18218	47	19500	46	20036	54	20138	49	20214	55
15837	39	15895	42	16512	47	16566	47	18219	47	19501	46	20039	55	20140	50	20217	55
15838	39	15896	42	16513	47	16567	47	18220	47	19505	46	20040	53	20144	49	20218	55
15839	39	16010	46	16514	47	16568	47	18221	47	19506	46	20041	54	20154	49	20219	55
15840	39	16118	44	16515	47	16569	47	18222	47	19507	46	20042	53	20164	49	20221	55
15841	39	16119	44	16516	47	16570	47	18223	47	19510	46	20043	53	20166	49	20222	55
15842	39	16120	44	16517	47	16571	47	18224	47	19511	46	20044	53	20167	49	20223	55
15843	39	16127	46	16518	47	16572	47	18227	47	19512	46	20045	53	20168	49	20224	55
15851	40	16128	46	16519	47	16573	47	18230	47	19513	46	20047	56	20169	49	20225	55
15852	40	16132	44	16520	47	16574	47	18232	47	19514	46	20048	59	20170	49	20226	55
15853	40	16308	47	16521	47	16577	47	18258	48	19515	46	20049	59	20171	49	20227	55
15854	40	16309	47	16522	47	16580	47	18259	48	19520	46	20051	59	20172	49	20233	55
15855	40	16310	47	16523	47	16582	47	18260	48	19521	46	20053	59	20173	49	20234	55
15856	40	16311	47	16524	47	17021	43	18261	48	19522	46	20054	59	20174	49	20235	55
15857	40	16312	47	16527	47	17022	43	18262	48	19525	46	20056	59	20175	49	20236	55
15858	40	16313	47	16530	47	17023	43	18263	48	19526	46	20057	59	20176	49	20238	55
15859	40	16314	47	16532	47	17024	43	18264	48	19527	46	20061	60	20177	49	20239	55
15860	40	16315	47	16537	47	17025	43	18265	48	20001	49	20062	60	20179	50	20240	55
15861	40	16316	47	16538	47	17026	43	18266	48	20002	49	20068	59	20180	50	20271	55
15862	40	16317	47	16539	47	17056	42	18267	48	20003	49	20069	59	20181	50	20273	55
15871	40	16318	47	16540	47	17057	42	18268	48	20004	49	20090	60	20182	50	20276	55
15872	40	16319	47	16541	47	17058	42	18269	48	20005	49	20094	60	20183	52	20277	55
15873	40	16358	47	16542	47	17059	42	18270	48	20006	49	20098	59	20184	52	20279	55
15874	40	16359	47	16543	47	17086	42	18271	48	20007	49	20111	49	20185	52	20280	55
15875	40	16360	47	16544	47	17087	42	18272	48	20008	49	20114	49	20186	53	20285	56
15876	40	16361	47	16546	47	17088	42	18273	48	20009	49	20115	49	20187	54	20286	56
15877	40	16362	47	16548	47	17089	42	18274	48	20010	49	20117	49	20188	54	20290	56
15878	40	16363	47	16549	47	18208	47	18277	48	20011	49	20119	49	20190	50	20302	56
15879	40	16364	47	16551	47	18209	47	18280	48	20012	49	20121	50	20195	53	20303	56
15880	40	16365	47	16552	47	18210	47	18282	48	20013	49	20122	50	20196	53	20305	56
15881	40	16366	47	16558	47	18211	47	18285	48	20014	50	20125	50	20197	53	20307	56
15882	40	16367	47	16559	47	18212	47	18286	48	20030	52	20127	50	20202	55	20312	56
15886	41	16368	47	16560	47	18213	47	18287	48	20031	52	20129	50	20203	55	20313	56
15887	41	16369	47	16561	47	18214	47	18288	48	20032	52	20131	49	20205	55	20314	56

INDEX

STOCK NO.	PAGE	STOCK NO.	PAGE	STOCK NO.	PAGE	STOCK NO.	PAGE	STOCK NO.	PAGE	STOCK NO.	PAGE	STOCK NO.	PAGE	STOCK NO.	PAGE		
20317	56	20734	51	25052	65	25115	66	25380	65	30054	70	31071	78	32407	81	35007	84
20318	56	20735	51	25053	65	25118	66	25384	65	30055	70	31072	78	32408	81	35008	84
20319	56	20737	51	25054	65	25119	66	25900	63	30056	70	31073	78	32409	81	35013	85
20321	56	20738	51	25056	65	25120	66	30001	67	30060	70	31081	77	32410	81	35014	85
20322	56	20739	51	25058	65	25121	62	30002	67	30061	70	31082	77	32411	81	35017	85
20323	56	20740	51	25060	65	25122	62	30003	67	30064	70	31099	77	32412	81	35018	85
20324	56	25001	62	25061	65	25123	62	30005	67	30065	70	31100	77	32413	81	35019	85
20325	56	25002	62	25062	65	25124	62	30006	67	30066	70	31105	77	32414	81	35020	85
20326	56	25003	62	25063	65	25125	62	30007	68	30080	67	32001	80	32415	81	35022	85
20327	56	25005	62	25065	65	25126	62	30008	68	30081	67	32005	80	32416	81	35023	85
20333	56	25006	62	25066	65	25130	63	30010	68	30086	68	32009	80	32417	81	35024	85
20334	56	25007	62	25067	65	25132	63	30011	68	30101	68	32013	80	32418	81	35026	85
20335	56	25008	62	25068	65	25133	63	30012	68	30102	68	32017	80	32419	81	35028	85
20336	56	25010	63	25069	65	25136	63	30013	68	30106	77	32021	80	32451	81	35030	85
20338	57	25012	63	25070	65	25142	63	30014	67	30108	68	32025	80	32452	81	35035	85
20339	57	25013	63	25071	65	25145	63	30015	67	30113	68	32029	80	32453	81	35037	86
20340	57	25016	63	25072	65	25148	64	30016	67	30116	68	32033	80	32454	81	35038	85
20360	57	25022	64	25073	65	25150	64	30017	68	31013	70	32037	80	32455	81	35039	85
20361	57	25025	64	25075	65	25151	63	30018	67	31014	77	32038	80	32456	81	35042	86
20365	57	25027	64	25079	65	25156	64	30019	68	31017	70	32046	81	32457	81	35043	86
20369	57	25028	64	25082	66	25158	64	30021	69	31018	78	32047	81	32458	81	35044	86
20370	57	25030	64	25083	66	25160	64	30022	69	31019	78	32048	81	32459	81	35046	86
20375	58	25031	64	25084	66	25164	64	30023	69	31020	78	32059	81	33001	82	35047	86
20376	58	25032	64	25085	66	25165	64	30030	69	31021	78	32060	81	33002	82	35048	86
20377	58	25033	65	25086	66	25167	65	30036	69	31022	78	32061	81	33003	82	35049	86
20385	57	25035	65	25087	66	25171	62	30037	69	31023	78	32062	81	33004	82	35053	86
20701	51	25037	65	25088	66	25172	62	30042	69	31024	78	32063	81	33005	82	35055	86
20702	51	25038	65	25090	66	25173	65	30043	93	31025	78	32065	81	33006	82	35059	86
20703	51	25040	65	25091	66	25175	65	30044	69	31031	78	32066	81	33008	83	35060	87
20705	51	25042	65	25093	66	25177	65	30045	69	31032	78	32100	81	33009	82	35061	87
20707	51	25043	63	25094	66	25185	64	30046	69	31045	78	32101	81	33011	83	35062	87
20708	51	25044	63	25097	66	25188	64	30048	69	31046	78	32401	81	33013	83	35080	85
20711	51	25045	63	25101	66	25190	64	30049	69	31048	79	32402	81	33021	83	35081	85
20712	51	25046	63	25104	66	25253	65	30050	70	31049	79	32403	81	33022	83	35111	87
20714	51	25047	63	25109	66	25254	65	30051	70	31065	70	32404	81	33100	82	35112	87
20716	51	25049	63	25111	66	25255	65	30052	70	31068	70	32405	81	33505	83	35113	87
20717	51	25051	65	25113	66	25256	65	30053	70	31070	78	32406	81	35006	84	35114	87

INDEX

STOCK NO.	PAGE	STOCK NO.	PAGE	STOCK NO.	PAGE	STOCK NO.	PAGE	STOCK NO.	PAGE	STOCK NO.	PAGE	STOCK NO.	PAGE	STOCK NO.	PAGE		
35115	87	35991	84	38049	94	40049	108	40133	108	41050	111	43011	61	44953	128	45106	119
35141	88	35992	84	38050	94	40050	108	40134	108	41051	111	43012	61	44963	128	45110	118
35153	88	35994	84	38051	94	40051	108	40135	108	41052	111	43020	61	45001	116	45111	118
35154	88	36002	84	38052	94	40054	108	40136	108	41053	111	43021	61	45002	116	45112	118
35155	87	36004	84	38054	94	40057	108	40144	107	41055	111	43022	61	45006	77	45113	118
35165	89	36005	84	38056	94	40058	109	40145	107	41056	111	43023	61	45010	116	45115	118
35168	89	36006	84	38060	95	40059	108	40201	107	41057	111	43024	61	45016	116	45116	118
35172	89	36012	84	38062	95	40068	109	40202	107	41058	111	43025	61	45024	116	45117	118
35176	89	36013	84	38064	95	40070	108	40204	107	41061	111	43028	61	45025	127	45118	118
35191	90	36014	84	38070	95	40071	108	40205	107	41062	111	43029	61	45026	127	45119	118
35192	90	36015	84	38071	95	40073	108	41000	110	41063	111	43030	61	45040	117	45120	118
35196	90	36016	84	38078	95	40075	109	41001	110	41064	111	43041	115	45041	117	45125	118
35199	91	38000	92	38090	128	40077	109	41002	110	41080	112	43042	115	45044	116	45126	118
35200	91	38001	92	38101	93	40079	109	41003	111	41081	112	43043	115	45047	116	45127	118
35201	91	38002	92	38102	93	40081	109	41004	111	41082	112	43044	115	45069	117	45128	118
35202	91	38003	92	38109	92	40083	109	41005	111	41083	112	43046	115	45071	117	45129	118
35210	86	38006	92	38110	92	40088	110	41008	110	41084	112	43048	115	45072	117	45130	118
35221	87	38007	92	38114	92	40090	109	41012	111	42000	114	43049	115	45073	117	45151	118
35223	87	38010	92	38115	92	40091	109	41013	111	42002	114	43050	115	45074	117	45152	118
35224	87	38011	92	40008	107	40092	110	41016	111	42003	114	43052	115	45075	128	45182	118
35225	87	38012	92	40010	107	40093	110	41017	111	42008	114	43060	115	45081	117	45188	118
35226	87	38013	93	40011	107	40096	110	41018	112	42013	114	43096	60	45083	117	45189	118
35227	87	38016	93	40012	107	40098	110	41019	111	42017	114	43099	60	45085	128	45190	118
35229	87	38020	93	40013	107	40099	110	41022	112	42018	114	43100	61	45086	128	45191	118
35231	87	38021	93	40014	107	40101	110	41029	112	42019	114	44002	127	45087	127	45197	121
35233	87	38022	93	40015	107	40102	110	41030	112	42021	114	44004	127	45092	118	45198	121
35234	87	38023	93	40016	107	40110	110	41031	112	42022	114	44031	127	45093	118	45199	121
35235	87	38024	93	40017	107	40111	110	41032	112	42025	114	44910	128	45094	118	45210	120
35236	87	38025	93	40018	107	40112	110	41033	112	42026	114	44911	128	45095	118	45211	120
35237	87	38030	96	40020	107	40121	107	41034	113	43001	60	44912	128	45096	121	45212	120
35238	87	38031	96	40021	107	40122	107	41035	113	43003	60	44928	128	45097	121	45213	120
35239	87	38033	96	40023	107	40123	107	41036	113	43005	61	44929	128	45098	121	45214	120
35243	87	38034	97	40024	107	40124	107	41037	112	43006	61	44935	128	45099	121	45215	120
35246	87	38035	97	40025	107	40125	107	41038	113	43007	61	44936	128	45100	121	45216	120
35981	84	38040	93	40038	108	40126	107	41039	113	43008	61	44940	128	45102	118	45217	120
35982	84	38041	93	40040	108	40131	108	41045	113	43009	61	44941	128	45103	118	45218	120
35984	84	38048	94	40048	108	40132	108	41047	113	43010	61	44952	128	45105	119	45219	120

INDEX

STOCK NO.	PAGE	STOCK NO.	PAGE	STOCK NO.	PAGE	STOCK NO.	PAGE	STOCK NO.	PAGE	STOCK NO.	PAGE	STOCK NO.	PAGE	STOCK NO.	PAGE	STOCK NO.	PAGE
45220	120	45376	119	50143	188	51017	191	54121	184	54281	185	57102	75	58006	79	62404	124
45221	120	45377	119	50144	188	54011	184	54122	184	54282	185	57111	75	60011	98	62411	124
45222	120	45378	119	50146	188	54012	184	54127	184	54283	185	57112	75	60015	98	62412	124
45223	120	45381	119	50150	188	54013	184	54128	184	54286	185	57113	75	60016	98	62413	124
45224	120	45382	119	50151	188	54021	184	54151	184	54287	185	57116	75	60018	98	62414	124
45225	120	45383	119	50153	188	54022	184	54152	184	54288	185	57117	76	60020	98	62442	126
45226	120	45384	119	50161	188	54023	184	54153	184	54291	185	57118	76	60021	98	62451	126
45227	120	45385	119	50163	188	54024	184	54161	184	54292	185	57119	76	60031	97	62452	126
45241	121	45386	119	50164	188	54025	184	54162	184	54301	185	57120	76	60033	97	62453	126
45242	121	45387	119	50166	188	54026	184	54163	184	54302	185	57125	76	60035	97	62491	125
45243	121	45388	119	50170	188	54031	184	54164	184	54303	185	57130	76	60050	99	62492	125
45244	121	50000	188	50171	188	54032	184	54165	184	54304	185	57160	76	60051	99	62600	190
45261	121	50004	192	50173	188	54033	184	54171	185	55103	186	57163	76	60055	98	62602	190
45266	121	50010	187	50190	115	54034	184	54173	185	55104	186	57164	76	60201	99	62605	191
45271	121	50011	187	50200	187	54035	184	54174	185	55105	186	57165	76	60202	99	62606	191
45276	121	50093	192	50202	187	54036	184	54175	185	55106	186	57168	76	60203	99	62610	190
45321	119	50100	192	50203	187	54051	184	54176	185	55108	186	57171	76	60204	99	62626	192
45322	119	50101	192	50206	187	54052	184	54177	185	55109	186	57211	77	60205	99	62635	192
45323	119	50102	192	50212	187	54053	184	54178	185	55111	186	57213	77	60206	99	62636	192
45324	119	50105	188	50216	187	54054	184	54179	185	55113	186	57221	77	60211	99	62661	189
45325	119	50106	188	50244	188	54055	184	54180	185	55114	186	57250	74	60212	99	62662	189
45326	119	50107	188	50245	188	54056	184	54181	185	55115	186	57261	77	60213	99	62663	189
45327	119	50108	188	50246	188	54057	184	54182	185	55116	186	57281	74	60214	99	62680	191
45328	119	50109	188	50248	188	54058	184	54183	185	55117	186	57292	74	62237	189	62683	191
45351	119	50110	188	50249	188	54066	184	54191	185	55118	186	57295	74	62239	189	62684	191
45352	119	50111	188	50270	188	54071	184	54192	185	55119	186	57393	77	62240	189	62685	191
45353	119	50112	188	50271	188	54072	184	54193	185	55120	186	57500	74	62242	189	65000	122
45354	119	50115	188	50281	188	54073	184	54194	185	55122	186	57502	74	62243	189	65001	122
45355	119	50116	188	50282	188	54074	184	54195	185	55123	186	57504	74	62246	189	65002	122
45356	119	50117	188	50521	188	54075	184	54196	185	55133	187	57506	74	62248	189	65003	122
45357	119	50118	188	50522	188	54086	184	54197	185	55134	187	57508	74	62252	190	65010	122
45358	119	50119	188	51011	191	54087	184	54198	185	55135	187	57510	74	62254	190	65011	122
45371	119	50120	188	51012	191	54088	184	54251	185	55136	187	57550	79	62261	189	65012	122
45372	119	50131	188	51013	191	54089	184	54261	185	55170	187	57555	79	62265	190	65013	122
45373	119	50132	188	51014	191	54112	184	54276	185	55175	187	58001	79	62401	124	65020	122
45374	119	50140	189	51015	191	54113	184	54277	185	57100	74	58002	79	62402	124	65021	122
45375	119	50141	188	51016	191	54120	184	54278	185	57101	74	58005	79	62403	124	65022	122

INDEX

STOCK NO.	PAGE	STOCK NO.	PAGE	STOCK NO.	PAGE	STOCK NO.	PAGE	STOCK NO.	PAGE	STOCK NO.	PAGE	STOCK NO.	PAGE	STOCK NO.	PAGE	STOCK NO.	PAGE
65023	122	65464	125	70123	197	70220	197	70308	198	70413	198	70626	199	72801	183	73455	181
65030	122	65482	126	70124	197	70221	197	70311	198	70414	198	70628	199	72802	183	73456	181
65031	122	65483	126	70125	197	70222	197	70312	198	70415	198	70801	199	72811	183	73457	181
65032	122	65484	126	70126	197	70223	197	70313	198	70421	198	70802	199	72812	183	73459	181
65033	122	65495	126	70127	197	70224	197	70314	198	70422	198	70806	200	73118	182	73462	181
65040	122	65497	192	70128	197	70225	197	70315	198	70423	198	70807	200	73119	182	73463	181
65041	122	65499	192	70129	197	70226	197	70316	198	70424	198	70810	200	73122	183	73464	181
65042	122	65501	123	70130	197	70230	198	70317	198	70425	198	71001	200	73125	183	73465	181
65043	122	65503	123	70131	197	70231	198	70324	198	70426	198	71002	200	73126	183	74606	154
65110	122	65505	123	70132	197	70232	198	70325	198	70427	198	71003	200	73130	182	74607	154
65200	122	65510	123	70140	197	70233	198	70326	198	70428	198	71004	200	73135	183	74608	154
65202	122	65515	123	70145	197	70234	198	70327	198	70429	198	71005	200	73151	179	74609	154
65211	123	65516	123	70151	197	70235	198	70328	198	70430	198	71006	200	73152	179	74611	154
65223	122	65601	126	70152	197	70236	198	70330	198	70431	198	71007	200	73159	179	74613	154
65225	122	66001	124	70153	197	70237	198	70331	198	70432	198	71008	200	73160	178	74614	154
65228	123	66003	124	70161	197	70238	198	70333	198	70481	199	71011	200	73170	178	74635	154
65230	123	66005	124	70162	197	70239	198	70334	198	70482	199	71012	200	73175	178	74636	154
65232	123	66011	124	70200	197	70240	198	70335	198	70511	199	71013	200	73180	178	74638	154
65402	125	66015	124	70201	197	70241	198	70336	198	70512	199	71014	200	73185	178	74640	154
65404	125	66020	124	70202	197	70250	198	70339	198	70513	199	71015	200	73191	178	74641	154
65406	125	66030	124	70203	197	70251	198	70341	198	70514	199	71016	200	73193	178	74802	154
65410	125	67202	124	70204	197	70252	198	70343	198	70520	199	71017	200	73195	179	74804	154
65420	125	70024	197	70205	197	70253	198	70344	198	70522	199	71018	200	73198	179	74822	154
65421	125	70108	197	70206	197	70254	198	70345	198	70601	199	71201	200	73301	179	74824	154
65421	125	70110	197	70207	197	70255	198	70394	198	70602	199	71211	200	73302	179	74826	154
65422	125	70111	197	70208	197	70256	198	70395	198	70603	199	71212	200	73315	180	74828	154
65422	125	70112	197	70209	197	70257	198	70396	198	70604	199	71213	200	73325	180	74830	154
65425	126	70113	197	70210	197	70258	198	70397	198	70606	199	71214	200	73382	180	74832	154
65427	126	70114	197	70211	197	70259	198	70398	198	70607	199	71215	200	73384	180	74842	154
65429	126	70115	197	70212	197	70260	198	70400	198	70608	199	71261	200	73395	180	74844	154
65431	126	70116	197	70213	197	70261	198	70401	198	70611	199	71271	200	73420	181	74846	154
65432	126	70117	197	70214	197	70302	198	70403	198	70612	199	71281	200	73425	181	74848	154
65433	126	70118	197	70215	197	70303	198	70404	198	70613	199	71805	200	73443	181	74850	154
65462	126	70119	197	70216	197	70304	198	70405	198	70614	199	71810	200	73444	181	74852	154
65462	126	70120	197	70217	197	70305	198	70406	198	70615	199	71820	200	73445	181	74864	154
65463	126	70121	197	70218	197	70306	198	70409	198	70620	199	71830	200	73448	181	74866	154
65463	126	70122	197	70219	197	70307	198	70411	198	70621	199	71835	200	73449	181	74868	154

INDEX

STOCK NO.	PAGE	STOCK NO.	PAGE	STOCK NO.	PAGE	STOCK NO.	PAGE	STOCK NO.	PAGE	STOCK NO.	PAGE	STOCK NO.	PAGE	STOCK NO.	PAGE		
74870	154	75111	156	75154	157	75205	157	75326	154	75408	154	75503	155	75604	158	75691	159
74872	154	75112	156	75155	157	75206	157	75327	154	75409	154	75504	155	75605	158	75692	159
74874	154	75113	156	75156	157	75207	157	75328	154	75410	154	75505	155	75606	158	75693	159
74886	154	75114	156	75157	157	75208	157	75329	154	75412	154	75506	155	75607	158	75694	159
74888	154	75115	156	75158	157	75209	157	75330	154	75414	154	75507	155	75608	158	75695	159
74890	154	75116	156	75159	157	75210	157	75337	154	75415	154	75508	155	75609	158	75696	159
74892	154	75117	156	75160	157	75211	157	75338	154	75416	154	75509	155	75610	158	75697	159
74894	154	75118	156	75161	157	75212	157	75342	154	75417	154	75510	155	75625	158	75699	159
74906	154	75119	156	75162	157	75213	157	75343	154	75421	154	75511	155	75626	158	75700	166
74908	154	75120	156	75163	157	75214	157	75344	154	75440	154	75512	155	75628	158	75701	166
74910	154	75121	156	75164	157	75215	157	75346	154	75441	154	75513	155	75631	158	75702	166
74912	154	75122	156	75165	157	75216	157	75347	154	75442	154	75514	155	75632	158	75703	166
74914	154	75123	156	75166	157	75217	157	75348	154	75448	155	75515	155	75633	158	75714	165
74916	154	75124	156	75167	157	75218	157	75349	154	75450	155	75516	155	75634	158	75716	165
74918	154	75125	156	75172	157	75219	157	75350	154	75451	155	75517	155	75635	158	75717	165
74921	154	75126	156	75173	157	75220	157	75352	154	75454	155	75518	155	75636	158	75719	165
75040	156	75127	156	75174	157	75221	157	75362	154	75455	155	75519	155	75637	158	75720	165
75041	156	75128	156	75180	158	75222	157	75363	154	75456	155	75520	155	75638	158	75721	165
75042	156	75129	156	75181	158	75223	157	75364	154	75457	155	75521	155	75639	158	75722	165
75043	156	75130	156	75182	158	75224	157	75365	154	75459	155	75522	155	75640	158	75725	165
75047	156	75131	156	75183	158	75225	157	75366	154	75460	155	75523	155	75641	158	75727	165
75055	156	75132	156	75184	158	75226	157	75367	154	75461	155	75530	156	75642	158	75729	165
75056	156	75133	156	75185	158	75227	157	75368	154	75462	155	75540	156	75643	158	75730	165
75061	156	75140	157	75186	158	75228	157	75369	154	75463	155	75544	156	75644	158	75732	165
75073	156	75141	157	75187	158	75301	154	75370	154	75464	155	75545	156	75645	158	75735	165
75080	157	75142	157	75188	158	75302	154	75372	154	75465	155	75547	156	75646	158	75738	165
75081	157	75143	157	75189	158	75303	154	75377	154	75466	155	75548	156	75647	158	75740	165
75082	157	75144	157	75190	158	75304	154	75378	154	75467	155	75549	156	75648	158	75743	165
75086	156	75145	157	75191	158	75306	154	75384	154	75468	155	75560	156	75649	158	75746	165
75087	156	75146	157	75192	158	75308	154	75386	154	75475	155	75564	156	75650	158	75748	165
75100	158	75147	157	75193	158	75317	154	75387	154	75476	155	75567	156	75654	159	75751	165
75105	156	75148	157	75194	158	75318	154	75388	154	75477	155	75568	156	75655	159	75752	165
75106	156	75149	157	75200	157	75321	154	75390	154	75478	155	75569	156	75656	158	75754	165
75107	156	75150	157	75201	157	75322	154	75392	154	75479	155	75600	158	75680	164	75757	165
75108	156	75151	157	75202	157	75323	154	75394	154	75500	155	75601	158	75681	164	75759	165
75109	156	75152	157	75203	157	75324	154	75396	154	75501	155	75602	158	75688	159	75760	165
75110	156	75153	157	75204	157	75325	154	75406	154	75502	155	75603	158	75690	159	75764	165

INDEX

STOCK NO.	PAGE	STOCK NO.	PAGE	STOCK NO.	PAGE	STOCK NO.	PAGE	STOCK NO.	PAGE	STOCK NO.	PAGE	STOCK NO.	PAGE	STOCK NO.	PAGE		
75765	165	75894	159	76171	160	76707	160	76804	167	77301	164	77626	162	79025	18	79520	135
75767	165	75896	159	76176	160	76710	161	76805	167	77302	164	77627	162	79029	19	79523	136
75768	165	75914	159	76301	160	76712	161	76806	167	77303	164	77629	163	79036	18	79524	136
75770	165	75915	159	76302	160	76713	161	76811	167	77305	164	77630	163	79036-BS	18	79525	137
75773	165	75920	159	76303	160	76715	161	76812	167	77311	164	77633	163	79037	19	79525-BS	137
75776	165	75922	159	76305	160	76717	161	76830	167	77312	164	77634	163	79038	19	79526	137
75779	165	75923	159	76307	160	76720	161	77110	162	77313	164	77635	163	79039	19	79527	136
75783	165	75925	159	76410	160	76722	161	77115	162	77315	164	77652	73	79100	150	79529	142
75786	165	75926	159	76419	160	76723	161	77201	164	77321	164	77653	73	79100-BS	150	79530	143
75802	165	75930	159	76420	160	76725	161	77202	164	77322	164	77654	73	79105	95	79532	140
75805	165	75932	159	76425	160	76727	161	77203	164	77323	164	77655	73	79110	95	79532-BS	140
75808	165	75935	159	76426	160	76730	161	77205	164	77325	164	77656	73	79111	95	79533	140
75814	165	75938	159	76430	160	76732	161	77211	164	77540	163	77657	73	79160	132	79534	139
75827	165	75940	159	76431	160	76733	161	77212	164	77542	163	77658	73	79161	132	79535	140
75833	165	75942	159	76432	160	76735	161	77213	164	77543	163	77659	73	79170	132	79535-BS	140
75840	165	75945	159	76440	160	76737	161	77215	164	77546	163	77812	58	79171	132	79537	141
75852	165	75948	159	76441	160	76740	161	77221	164	77548	163	77817	58	79180	132	79538	142
75858	165	75950	159	76450	160	76742	161	77222	164	77550	163	77823	58	79181	132	79538-BS	142
75860	165	75955	159	76451	160	76743	161	77223	164	77552	163	77825	58	79182	132	79539	139
75861	165	75965	159	76460	160	76745	161	77225	164	77553	163	77830	58	79500	130	79540	141
75863	166	75970	159	76461	160	76747	161	77231	164	77554	163	77831	58	79500-BS	130	79542	135
75865	165	75975	159	76470	160	76750	161	77232	164	77600	162	77832	58	79501A	130	79543	135
75866	165	76101	159	76540	160	76751	161	77233	164	77601	162	77838	58	79502A	130	79551	141
75867	166	76102	159	76560	160	76752	161	77234	164	77602	162	77841	58	79503A	130	79551-BS	141
75868	166	76103	159	76561	160	76753	161	77235	164	77603	162	77842	58	79504	131	79555	142
75869	166	76105	159	76570	160	76754	161	77236	164	77605	162	77843	58	79505	131	79555-BS	142
75870	166	76107	159	76571	160	76756	162	77237	164	77606	162	77845	58	79505-BS	131	79558	141
75871	167	76120	159	76680	162	76757	162	77241	164	77607	162	77846	58	79505A	131	79560	159
75872	167	76131	159	76681	162	76759	162	77242	164	77610	162	77847	58	79505A-BS	131	79562	138
75873	167	76132	159	76682	162	76760	161	77243	164	77611	162	77848	58	79506	131	79564	138
75875	167	76133	159	76683	162	76762	161	77244	164	77612	162	77849	58	79506-BS	131	79566	138
75877	167	76134	159	76684	162	76763	161	77245	164	77613	162	77858	58	79506A	131	79568	140
75878	167	76141	160	76685	162	76765	161	77246	164	77615	162	77861	58	79506A-BS	131	79568-BS	140
75879	167	76142	160	76700	160	76767	161	77247	164	77616	162	77863	58	79509	151	79576	146
75881	166	76143	160	76702	160	76801	167	77260	164	77617	162	77864	59	79510	132	79577	149
75890	159	76145	160	76703	160	76802	167	77261	164	77621	162	77865	59	79510-BS	132	79578	149
75891	159	76147	160	76705	160	76803	167	77262	164	77622	162	79010	18	79519	135	79579	149

INDEX

STOCK NO.	PAGE	STOCK NO.	PAGE	STOCK NO.	PAGE	STOCK NO.	PAGE	STOCK NO.	PAGE	STOCK NO.	PAGE	STOCK NO.	PAGE	STOCK NO.	PAGE		
79584	138	79891	170	80211	194	87213	7	88550-BS	133	V30208	103	V31425	104	V40309	105	V83306	102
79585	139	79892	170	80212	194	87215	7	88551	134	V30210	103	V31430	104	V40310	105	V83411	102
79588	145	79893	170	80221	194	87223	10	88552	134	V30212	103	V31600	104	V40311	105	V83606	105
79589	145	79953	151	80306	193	87225	12	88552-BS	134	V30400	103	V31601	104	V40312	105	V83718	106
79598	151	79961	148	83013	99	87228	11	88553	134	V30401	103	V31602	104	V40313	105	V83825	106
79599	151	79962	148	83021	195	87233	12	88580	136	V30402	103	V31806	104	V40314	105	V90047	105
79600	151	79963	148	83024	195	87239	9	88580-BS	136	V30403	103	V31808	104	V40315	105		
79601	151	79964	148	83037	195	87240	9	88598	139	V30600	103	V31810	104	V40316	105		
79602	151	79966	148	83039	195	87252	8	90001	201	V30601	103	V31815	104	V40317	105		
79604	150	79968	148	85300	31	87254	7	90002	201	V30602	103	V31820	104	V40318	105		
79606	150	79969	148	85301	31	87256	8	90005	201	V30603	103	V32007	104	V40319	105		
79608	146	79970	147	85350	21	87258	9	90006	201	V30810	103	V32408	103	V40321	105		
79609	146	79973	147	85352	22	87272	10	90008	201	V30815	103	V33212	104	V40322	105		
79611	73	79975	147	85354	23	87278	10	90009	195	V30820	103	V33506	103	V40324	105		
79614	73	79978	148	85355	24	87280	11	90010	201	V30825	103	V40106	104	V40327	105		
79620	73	79978	148	85361	31	87282	11	90011	201	V30830	103	V40107	104	V40330	105		
79624	72	79979	148	85401	30	87308	17	90015	201	V31003	103	V40108	104	V40332	105		
79626	72	79979	148	85410	20	87311	13	90018	201	V31004	103	V40109	104	V40520	105		
79628	72	79981	149	85531-BS	133	87312	13	90019	201	V31005	103	V40110	104	V40525	105		
79629	72	79982	149	86101	173	87338	12	90024	201	V31006	103	V40111	104	V42710	105		
79646	142	79986	171	86102	173	87340	13	90025	201	V31008	103	V40112	104	V42711	105		
79646-BS	142	79987	171	86103	173	87360	14	V12224	105	V31025	103	V40113	104	V42712	105		
79648	142	79988	171	86104	173	87362	14	V16006	101	V31204	103	V40114	104	V42713	105		
79648-BS	142	79991	169	86109	174	87366	14	V16007	101	V31205	103	V40115	104	V42714	105		
79650	144	79992	169	86110	174	87370	15	V16008	101	V31206	103	V40116	104	V42715	105		
79651	144	79993	169	86124	174	87372	15	V16026	101	V31207	103	V40117	104	V42716	105		
79652	144	79997	126	86125	174	87380	15	V16028	101	V31208	103	V40118	104	V42717	105		
79654	144	80040	195	86141	175	87381	16	V16036	101	V31209	103	V40119	104	V42718	105		
79656	145	80042	17	86142	175	87472	16	V16037	101	V31210	103	V40121	104	V42719	105		
79660	143	80101	194	86153	175	87474	16	V16046	101	V31211	103	V40122	104	V50418	105		
79662	143	80102	194	86154	175	87485	17	V16056	102	V31212	103	V40124	104	V51416	105		
79664	143	80103	194	86161	175	87486	17	V16066	102	V31213	103	V40127	104	V70670	104		
79685	21	80112	194	86162	175	88530	132	V16096	101	V31214	103	V40130	104	V80107	102		
79787	146	80120	195	86183	176	88530-BS	132	V16098	101	V31255	103	V40132	104	V80114	102		
79788	146	80130	195	86184	176	88531	133	V30204	103	V31415	104	V40306	105	V82115	106		
79789	146	80190	193	86195	176	88540	133	V30205	103	V31418	104	V40307	105	V83103	102		
79792	150	80201	193	87212	8	88550	133	V30206	103	V31420	104	V40308	105	V83204	102		



TOLSEN TOOLS AND MORE



CATALOG
2023
— 01 —

engineered
to
get the job done



know more
about us!

SUZHOU TOLSEN TOOLS CO.,LTD.

198 HUASHAN ROAD, ZHANGJIAGANG,
JIANGSU, CHINA

Tel:
0086-512-55398658
0086-512-55398652

E-mail:
sales@tolsentools.com

www.tolsentools.com



WeChat:
tolsentools

WhatsApp:
008613584426700

QQ:
2881527359

**DISTRIBUTOR
INFORMATION:**